

2023
2024



MEASURING INSTRUMENTS

CATALOGUE NO. EU260

**BEST
SELLER**



All products in this catalogue are usually stocked and available from INSIZE Europe in Spain (subject to our final confirmation)

PRODUCT INDEX

1 DATA OUTPUT

PAGE 1-3



WIRELESS DATA TRANSMISSION SYSTEMS



DATA OUTPUT CABLES

2 CALIPERS

PAGE 3-25



CALIPERS



DEPTH BASE ATTACHMENTS



ACCESSORY SETS FOR DIGITAL CALIPERS



CARBON FIBER COMPARISON GAGES



SPECIAL PURPOSE CALIPERS

5 MICROMETERS

PAGE 34-46



HIGH PRECISION DIGITAL MICROMETERS/SNAP GAGES



OUTSIDE MICROMETERS



MICROMETERS WITH DIAL INDICATOR



SPECIAL PURPOSE MICROMETERS



3-WIRES



MICROMETER HEADS



MICROMETER STANDS

6 BORE DIAMETER, RADIUS MEASURING INSTRUMENTS

PAGE 47-55



PISTOL GRIP THREE POINTS BORE GAGES



THREE POINTS INTERNAL MICROMETERS



INSIDE MICROMETERS



TUBULAR INSIDE MICROMETERS



BORE GAGES



BORE GAGE SETTERS



TELESCOPING GAGE SETS



RADIUS GAGES



DIGITAL RADIUS CALIPERS



CIRCUMFERENCE TAPES

3 DEPTH MEASURING INSTRUMENTS

PAGE 25-30



DEPTH GAGES



DIAL DEPTH GAGES



DEPTH MICROMETERS

4 HEIGHT MEASURING INSTRUMENTS

PAGE 30-34



DIGITAL HEIGHT GAGES



HEIGHT GAGES



MINI DIGITAL HEIGHT GAGES

7 INDICATORS, STANDS, BENCH CENTERS

PAGE 56-77



DIAL INDICATORS



POINTS



LINEAR GAGES



DIAL TEST INDICATORS



DIAL TEST INDICATOR HOLDERS



DIAL INDICATOR TESTERS



MAGNETIC STANDS



DIAL INDICATOR STANDS



CONCENTRICITY GAGES



BENCH CENTERS



SHANK RUNOUT TESTERS

8 INDICATING MEASURING INSTRUMENTS

PAGE 78-82



INTERNAL/EXTERNAL CALIPER GAGES



THICKNESS GAGES



DIAL SNAP GAGES



DIAL SNAP GAGES



STEP AND GAP GAGES



CRANKSHAFT TESTERS



KEYWAY DEPTH GAGES

PRODUCT INDEX

10 ANGLE AND STRAIGHTNESS MEASURING INSTRUMENTS PAGE 94-99

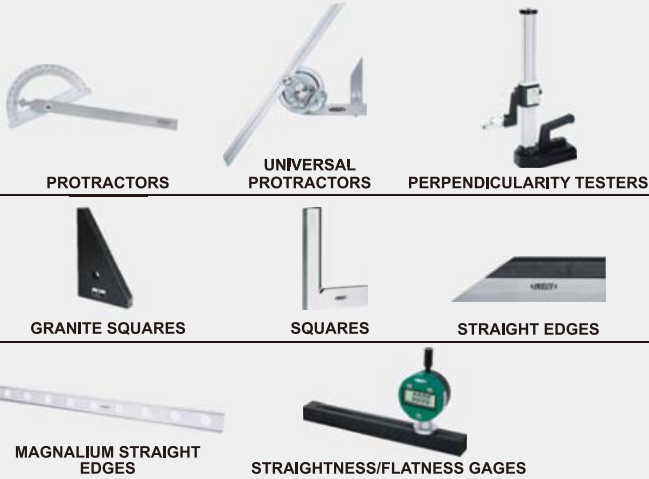

11 SIMPLE MEASURING TOOLS PAGE 99-114



13 SCALES PAGE 123-124

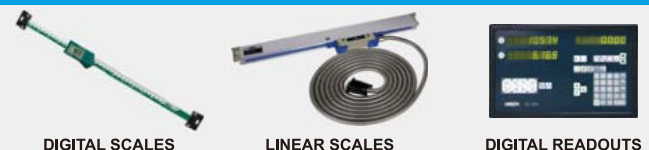

9 STANDARDS AND GAGE BLOCKS PAGE 82-93

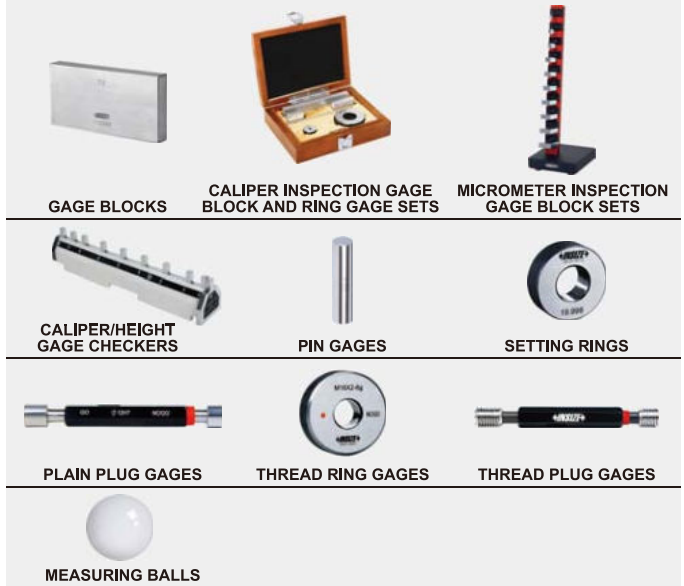

12 SET-UP TOOLS PAGE 114-122



14 ROUNDNESS, PROFILE AND ROUGHNESS TESTERS PAGE 125-129



PRODUCT INDEX

15

PAGE 130-135



JIG SETS FOR CMM



LASER SCAN MICROMETERS



OPTICAL TRANSMISSION PROBES



TOOL PRESETTERS

16

PAGE 135-141



PROFILE PROJECTORS



QUICK MEASUREMENT SYSTEMS



VISION MEASURING SYSTEMS

17 MICROSCOPES

PAGE 142-156



TOOLMAKER MICROSCOPES



DIGITAL MICROSCOPES



MICROSCOPES



DIGITAL CAMERAS



PORTABLE MEASURING MICROSCOPES

21 HARDNESS TESTERS

PAGE 188-200



HARDNESS TESTERS

24 SCALES

PAGE 209-213



ELECTRONIC BALANCES



CRANE SCALES



PLATFORM SCALES

18 MAGNIFIERS, VIDEOSCOPIES

PAGE 156-162

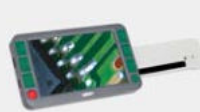

DIGITAL MAGNIFIERS



TABLE MAGNIFIERS WITH ILLUMINATION



MAGNIFIERS



TELESCOPING INSPECTION MIRRORS



VIDEOSCOPIES

19 PORTABLE INSTRUMENTS

PAGE 163-183



20 LEVELS

PAGE 183-187



CROSS-LINE LASER LEVELS



22 FORCE GAGES

PAGE 200-205



DIGITAL LEVELS AND SLOPE METERS

23 TORQUE TESTERS TORQUE WRENCHES

PAGE 205-208



TORQUE TESTERS



TORQUE SCREWDRIVERS



TORQUE WRENCHES

25 INCH PRODUCTS

PAGE 214-215



DIAL CALIPERS



OUTSIDE MICROMETERS



DEPTH MICROMETERS



DIAL INDICATORS



DIAL TEST INDICATORS



FEELER GAGES

DATA OUTPUT CABLES (KEYBOARD FORMAT)



7302-40M

- Recognized as HID keyboard device by computer, no need to install drivers and softwares
- Data can be transmitted to Excel, Word, txt and other files (press transmit button, which is recognized by the computer as keyboard input data and press enter, such as 12.34 ✓)
- Suitable for any softwares which can receive keyboard signal
- Optional accessory: foot switch (code: 7304-2), hub (code: 7324-HUB4, 7324-HUB7) extension cables (code: 7325-ADD5, 7325-ADD10)

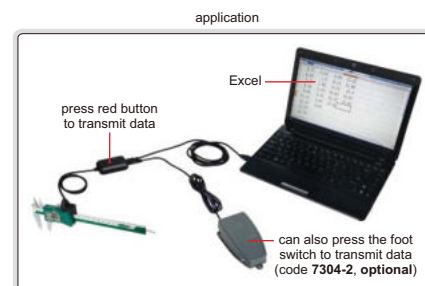

Code	Description	Plug to product	Plug to computer	Applicable products
7302-21	cable for digital calipers (length 3m)			<p>digital calipers and digital depth gages</p>
7302-22	cable for large digital calipers (length 2.5m)			<p>large digital calipers (range ≤1000mm) and digital height gages</p>
7302-30	cable for digital micrometers (length 2.5m)			<p>digital micrometers</p>
7302-40M*	cable for digital indicators (length 2.5m)			<p>digital indicators</p>
7302-50M	cable for digital gages (length 2.5m)			<p>digital thickness gages and digital internal/external caliper gages</p>
7302-60	cable for high precision digital indicators (length 2.5m)			<p>2140-6 and 2133 series high precision digital indicators</p>

*Long press transmit button to zero the digital indicators





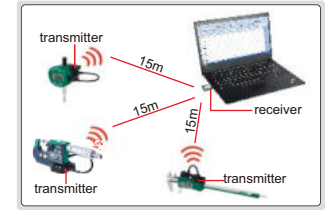
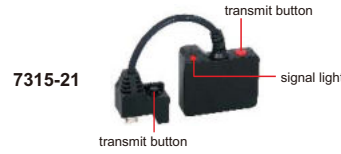





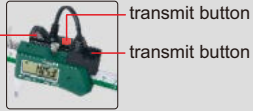

WIRELESS DATA TRANSMISSION SYSTEM

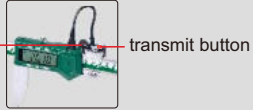
- Through wireless transmission, the measurement data can be transmitted to computers or mobile phones
- Wireless zigbee protocol, conforming to IEEE802, 2.4GHz band
- Transmission distance is 15 meter (Under the condition of no obstruction and no electromagnetic interference. The transmission distance of built-in wireless measuring tools can be found in their respective introduction.)





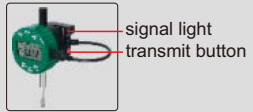

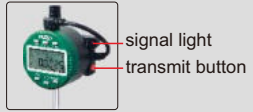
Transmitter

- Connecting to digital measuring tools such as calipers, micrometers and indicators
- Press the transmit button to send data
- CR2032 battery

Code	Description	Plug to product	Remark
7315-21	transmitter for digital calipers	 transmit button	 digital calipers and digital depth gages 
7315-22	transmitter for large digital calipers		 large digital calipers (range≤1000mm) and digital height gages 
7315-30	transmitter for digital micrometers		 digital micrometers 
7315-50M	transmitter for digital indicators		 digital indicators, digital thickness gages and digital internal/external caliper gages 
7315-60	transmitter for high precision digital indicators		 2140-6 and 2133 series high precision digital indicators 

Receiver (keyboard signal)

- For computers and mobile phones with windows, android and ios systems
- Recognized as HID keyboard device, press transmit button of transmitter, which is recognized by computers or mobile phones as keyboard input data and press enter, such as 12.34∟.
- No need to install drivers and softwares
- Data can be transmitted to excel, word, txt etc.
- Suitable for any softwares which can receive keyboard signal

Code	Product	Description	Remark
7315-3	 USB port	single channel receiver	connected with 1 transmitter only
7315-6	 USB port	multichannel receiver	connected with 6 transmitter, each channel has a transmitter status indicator
7315-7	 type-C port		
7315-8	 micro USB port		
7315-9	 lightning port		

To be continued

Continued from previous page

Receiver (text format, virtual com port)

- Suitable for computers with windows system
- Text format virtual com port, converted to keyboard format with supplied software
- Supplied with EXCEL directional input software (please refer to the next page for details)
- Measurement data can be transmitted to excel, word, txt etc. and any software which receives keyboard signal

Code	Product	Description	Remark
7315-2		multichannel receiver	connected with maximum 16 transmitters, each of them has unique identification code

EXCEL directional input software

- Included in 7315-2 receiver
- The measurement data of multiple measuring tools can be transmitted to the designated area of excel, which facilitates data management and improves efficiency

Excel directional input software (included in 7315-2), application example 1

Set the display area of caliper at B4-B9, the readings of caliper are displayed at B4, B5... B9.
Set the display area of micrometer at C4-C9, the readings of micrometer are displayed at C4, C5... C9.
Set the display area of height gage at D4-D9, the readings of height gage are displayed at D4, D5... D9.

Project	Length	Width	Height
Dimension and Tolerance	50±0.05	24±0.01	10±0.05-0.06
Measuring tool	Caliper	Micrometer	Height gage
1	50.02	24.004	9.98
2	50.01	24.010	10.01
3	49.99	23.990	10.02
4	50.00	23.996	9.99
5	50.04	24.000	10.01
6			

serial of workpieces the next data display area is indicated in green

Excel directional input software (included in 7315-2), application example 2

Set the display area of micrometer at B4-C9, data input is from the left to the right, the readings of micrometer are displayed at B4, C4, B5, C5... B9, C9.
Set the display area of caliper at D4-D9, the readings of caliper are displayed at D4, D5... D9.
Set the display area of depth gage at E4-E9, the readings of depth gage are displayed at E4, E5... E9.

Project	External diameter	External diameter	Length	Depth
Dimension and Tolerance	Φ23±0.01-0.02	Φ23±0.01-0.02	50±0.04	28±0.05
Measuring tool	Micrometer	Micrometer	Caliper	Depth gage
1	23.010	23.000	49.99	28.01
2	23.010	23.000	50.00	27.98
3	23.999	23.000	50.00	28.00
4	23.007	23.996	50.00	28.00
5	23.000	23.985	50.01	28.01
6	23.005			

serial of workpieces the next data display area is indicated in green

FOOT SWITCH

- For data transmission

Code	Description	Applicable products
7304-2	data transmission foot switch with cable (length 2m)	7302 series data cables 7305 series data cables



7304-2

application

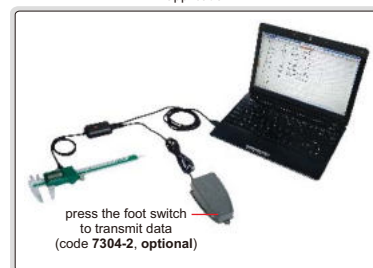

press the foot switch to transmit data (code 7304-2, optional)

WIRELESS DIGITAL CALIPERS

ATTENTION: THE WORKING LIFE OF A BATTERY IS ABOUT 3-5 MONTHS

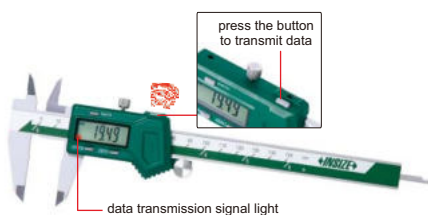
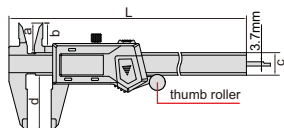

1113-150

- Built-in wireless data transmission module, Zigbee signal
- Transmission distance is 10 meter (under the condition of no obstruction and no electromagnetic interference)
- Resolution: 0.01mm/0.0005"
- Buttons: on/off, zero, mm/inch, data transmission
- Automatic power off, move the digital unit to turn on power
- Battery CR2032
- Made of stainless steel
- Optional accessory: receiver (code 7315-2/3/6/7/8/9)

receiver (optional)

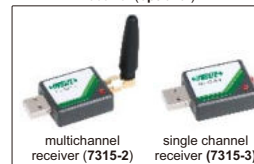

multichannel receiver (7315-2) single channel receiver (7315-3)

(mm)

Code	Range	Accuracy	Thumb roller	L	a	b	c	d
1113-150*	0-150mm/0-6"	±0.03mm	with	236	21	16	16	40
1113-200*	0-200mm/0-8"	±0.03mm	with	286	24	19	16	50
1113-300*	0-300mm/0-12"	±0.03mm	with	400	25	20.5	16	60
1113-150W*	0-150mm/0-6"	±0.03mm	without	236	21	16	16	40
1113-200W*	0-200mm/0-8"	±0.03mm	without	286	24	19	16	50
1113-300W*	0-300mm/0-12"	±0.03mm	without	400	25	20.5	16	60

*Supplied with manufacturer inspection certificate

application

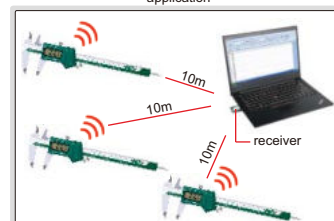

IP67 WATERPROOF DIGITAL CALIPERS



ATTENTION: IT IS NECESSARY TO SET ZERO AFTER POWER ON EACH TIME

ATTENTION: NO DATA OUTPUT

IP67
WATERPROOF

- Accuracy: $\pm 0.03\text{mm}$
- IP67 dust/waterproof
- Resolution: 0.01mm/0.0005"
- Button function: zero, on/off, mm/inch, ABS/REL, hold
- Battery CR2032, meet DIN862
- Made of stainless steel



1118-150B

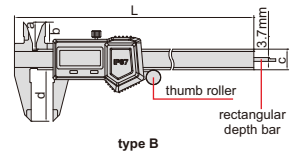

type B



1118-150R

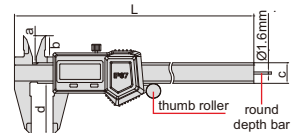

type R

(mm)

Code	Range	Thumb roller	Type	L	a	b	c	d
1118-150B*	0-150mm/0-6"	with	B	236	21	16	16	40
1118-200B*	0-200mm/0-8"	with	B	286	24	19	16	50
1118-300B*	0-300mm/0-12"	with	B	400	25	20.5	16	60
1118-150BW*	0-150mm/0-6"	without	B	236	21	16	16	40
1118-200BW*	0-200mm/0-8"	without	B	286	24	19	16	50
1118-300BW*	0-300mm/0-12"	without	B	400	25	20.5	16	60
1118-150R*	0-150mm/0-6"	with	R	236	21	16	16	40

*Supplied with manufacturer inspection certificate

DIGITAL CALIPERS (FRACTION READING)



ATTENTION: NO DATA OUTPUT

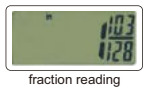

fraction reading



1102-150

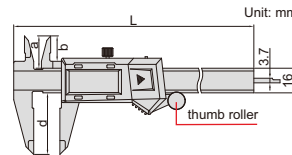

Unit: mm

thumb roller

- Accuracy: $\pm 0.03\text{mm}$
- Resolution: 0.01mm, 0.0005", 1/128"
- Buttons: unit (mm/in/fraction), ABS, on/off, zero
- Absolute and incremental measurement
- Battery CR2032, automatic power off
- Meet DIN862
- Made of stainless steel

(mm)

Code	Range	Thumb roller	L	a	b	d
1102-150*	0-150mm/0-6"	with	234	20	15	40
1102-200*	0-200mm/0-8"	with	286	24	19	50
1102-300*	0-300mm/0-12"	with	390	26	21.5	60
1102-150W*	0-150mm/0-6"	without	234	20	15	40
1102-200W*	0-200mm/0-8"	without	286	24	19	50
1102-300W*	0-300mm/0-12"	without	390	26	21.5	60

*Supplied with manufacturer inspection certificate

DIGITAL CALIPERS (ABSOLUTE SYSTEM)



DATA OUTPUT



1103-150

- Absolute system, low power consumption, long battery life
- Accuracy: $\pm 0.03\text{mm}$
- Resolution: 0.01mm/0.0005"
- Buttons: on/off, mm/inch, ORIGIN, ZERO/ABS
- Automatic power off, move the digital unit to turn on power
- Battery CR2032, data output
- Meet DIN862
- Made of stainless steel
- Optional accessory: wireless transmitter, code 7315-1103, data output cable (keyboard format), code 7302-1103

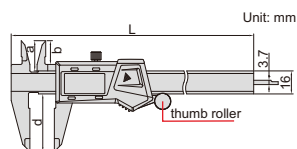

Unit: mm

thumb roller

(mm)

Code	Range	Thumb roller	L	a	b	d
1103-150*	0-150mm/0-6"	with	236	21	16.5	40
1103-200*	0-200mm/0-8"	with	286	24	19.5	50
1103-300*	0-300mm/0-12"	with	400	26	21.5	60
1103-150W*	0-150mm/0-6"	without	236	21	16.5	40
1103-200W*	0-200mm/0-8"	without	286	24	19.5	50
1103-300W*	0-300mm/0-12"	without	400	26	21.5	60

*Supplied with manufacturer inspection certificate

DIGITAL CALIPERS (STANDARD TYPE)

DATA OUTPUT

INSPECTION CERTIFICATE

ATTENTION: NOT WATERPROOF



1108-150

- Resolution: 0.01mm/0.0005"
- Buttons: on/off, zero, mm/inch
- Automatic power off, move the digital unit to turn on power
- Battery CR2032
- Data output, meet DIN862
- Made of stainless steel
- Optional accessory: data output cable (code 7315-21, 7302-21)

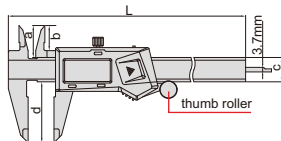

With thumb roller (mm)

Code	Range	Accuracy	L	a	b	c	d
1108-150*	0-150mm/0-6"	±0.02mm	236	21	16	16	40
1108-200*	0-200mm/0-8"	±0.03mm	286	24	19	16	50
1108-300*	0-300mm/0-12"	±0.03mm	400	25	20.5	16	60

Without thumb roller (mm)

Code	Range	Accuracy	L	a	b	c	d
1108-150W*	0-150mm/0-6"	±0.02mm	236	21	16	16	40
1108-200W*	0-200mm/0-8"	±0.03mm	286	24	19	16	50
1108-300W*	0-300mm/0-12"	±0.03mm	400	25	20.5	16	60

*Supplied with manufacturer inspection certificate

DIGITAL CALIPERS

ATTENTION: NO DATA OUTPUT

INSPECTION CERTIFICATE



1114-150A

- Zinc alloy housing for digital unit
- Resolution: 0.01mm/0.0005"
- Buttons: zero, on/off, mm/inch
- Automatic power off, move the digital unit to turn on power
- Battery CR2032, meet DIN862
- Made of stainless steel

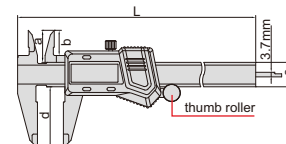

With thumb roller (mm)

Code	Range	Accuracy	L	a	b	c	d
1114-150A*	0-150mm/0-6"	±0.03mm	236	21	16	16	40
1114-200A*	0-200mm/0-8"	±0.03mm	286	24	19	16	50
1114-300A*	0-300mm/0-12"	±0.03mm	400	25	20.5	17	60

Without thumb roller (mm)

Code	Range	Accuracy	L	a	b	c	d
1114-150AW*	0-150mm/0-6"	±0.03mm	236	21	16	16	40
1114-200AW*	0-200mm/0-8"	±0.03mm	286	24	19	16	50
1114-300AW*	0-300mm/0-12"	±0.03mm	400	25	20.5	17	60

*Supplied with manufacturer inspection certificate

HEAVY DUTY 300mm DIGITAL CALIPERS

INSPECTION CERTIFICATE

DATA OUTPUT



1196-300

- Resolution: 0.01mm/0.0005"
- Buttons: on/off, zero, mm/inch
- Automatic power off, move the digital unit to turn on power
- Battery CR2032
- Data output
- Meet DIN862
- Made of stainless steel
- Optional accessory: data output cable (code 7315-22, 7302-22)

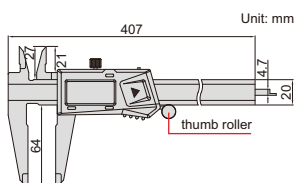

Code	Range	Accuracy	Thumb roller
1196-300*	0-300mm/0-12"	±0.03mm	with
1196-300W*	0-300mm/0-12"	±0.03mm	without

*Supplied with manufacturer inspection certificate

DIGITAL CALIPERS WITH ROUND DEPTH BAR

DATA OUTPUT

INSPECTION CERTIFICATE



1119-150



round depth bar Ø1.6mm

- Resolution: 0.01mm/0.0005"
- Buttons: on/off, zero, mm/inch
- Automatic power off, move the digital unit to turn on power
- Battery CR2032
- Data output
- Meet DIN862
- Made of stainless steel
- Optional accessory: data output cable (code 7315-21, 7302-21)

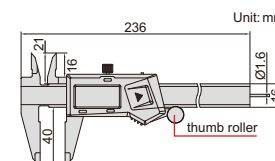

Code	Range	Accuracy	Thumb roller
1119-150*	0-150mm/0-6"	±0.03mm	with
1119-150W*	0-150mm/0-6"	±0.03mm	without

*Supplied with manufacturer inspection certificate

METRIC DIGITAL CALIPERS

DATA OUTPUT

LOCK READING WITH "HOLD" BUTTON

INSPECTION CERTIFICATE



1109-150

- Resolution: 0.01mm
- Buttons: on/off, zero, hold
- Automatic power off, move the digital unit to turn on power
- Battery CR2032
- Data output, meet DIN862
- Made of stainless steel
- Optional accessory: data output cable (code 7315-21, 7302-21)

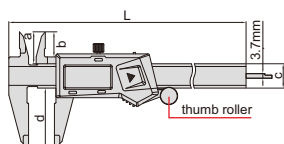

Code	Range	Accuracy	Thumb roller	L	a	b	c	d
1109-150*	0-150mm	±0.03mm	with	236	21	16	16	40
1109-200*	0-200mm	±0.03mm	with	286	24	19	16	50
1109-300*	0-300mm	±0.03mm	with	400	25	20.5	16	60
1109-150W*	0-150mm	±0.03mm	without	236	21	16	16	40
1109-200W*	0-200mm	±0.03mm	without	286	24	19	16	50
1109-300W*	0-300mm	±0.03mm	without	400	25	20.5	16	60

*Supplied with manufacturer inspection certificate

DIGITAL CALIPERS WITH CARBIDE TIPPED JAWS

DATA OUTPUT

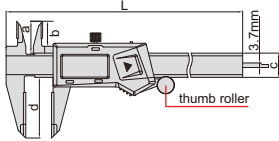

1110-150A



1110-150B

- Accuracy: $\pm 0.03\text{mm}$
- Resolution: $0.01\text{mm}/0.0005''$
- Buttons: on/off, zero, mm/inch
- Automatic power off, move the digital unit to turn on power
- Battery CR2032, data output
- Meet DIN862
- Made of stainless steel
- Optional accessory: data output cable (code 7315-21, 7302-21)

Carbide tipped upper and lower jaws (mm)

Code	Range	Thumb roller	L	a	b	c	d
1110-150A*	0-150mm/0-6"	with	236	21	16	16	40
1110-200A*	0-200mm/0-8"	with	286	24	19	16	50
1110-300A*	0-300mm/0-12"	with	400	25	20.5	16	60
1110-150AW*	0-150mm/0-6"	without	236	21	16	16	40
1110-200AW*	0-200mm/0-8"	without	286	24	19	16	50
1110-300AW*	0-300mm/0-12"	without	400	25	20.5	16	60

Carbide tipped lower jaws (mm)

Code	Range	Thumb roller	L	a	b	c	d
1110-150B*	0-150mm/0-6"	with	236	21	16	16	40
1110-200B*	0-200mm/0-8"	with	286	24	19	16	50
1110-300B*	0-300mm/0-12"	with	400	25	20.5	16	60
1110-150BW*	0-150mm/0-6"	without	236	21	16	16	40
1110-200BW*	0-200mm/0-8"	without	286	24	19	16	50
1110-300BW*	0-300mm/0-12"	without	400	25	20.5	16	60

*Supplied with manufacturer inspection certificate

DIGITAL CALIPERS WITH CERAMIC TIPPED JAWS

DATA OUTPUT

- Ceramic tipped jaws for outside measurement, extremely wear-resistant, non-magnetic and non electric conductive
- Resolution: $0.01\text{mm}/0.0005''$
- Buttons: on/off, zero, mm/inch
- Automatic power off, move the digital unit to turn on power
- Battery CR2032, data output
- Made of stainless steel
- Meet DIN862
- Optional accessory: data output cable (code 7315-21, 7302-21)



1193-150

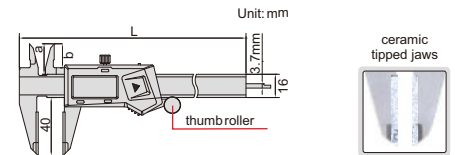

(mm)

Code	Range	Accuracy	Thumb roller	L	a	b
1193-150*	0-150mm/0-6"	$\pm 0.03\text{mm}$	with	235	21	16.5
1193-150W*	0-150mm/0-6"	$\pm 0.03\text{mm}$	without	235	21	16.5

*Supplied with manufacturer inspection certificate

LEFT HAND DIGITAL CALIPERS

DATA OUTPUT

- Designed for left handed users
- Resolution: $0.01\text{mm}/0.0005''$
- Buttons: on/off, zero, mm/inch
- Automatic power off, move the digital unit to turn on power
- Battery CR2032, data output
- Meet DIN862
- Made of stainless steel
- Optional accessory: data output cable (code 7315-22, 7302-22)



1130-150

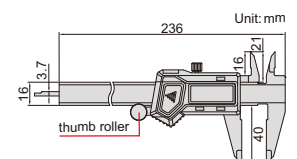

Code	Range	Accuracy	Thumb roller
1130-150*	0-150mm/0-6"	$\pm 0.03\text{mm}$	with
1130-150W*	0-150mm/0-6"	$\pm 0.03\text{mm}$	without

*Supplied with manufacturer inspection certificate

MINI DIGITAL CALIPERS

ATTENTION:
NO DATA OUTPUT



1111-100A

- Resolution: 0.01mm/0.0005"
- Buttons: zero, mm/inch, on/off
- Automatic power off, move the digital unit to turn on power
- Battery LR44
- Meet DIN862
- Made of stainless steel

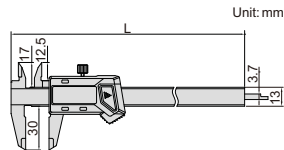

Unit: mm

Code	Range	Accuracy	L
1111-75A	0-75mm/0-3"	±0.02mm	144mm
1111-100A	0-100mm/0-4"	±0.02mm	170mm

DIGITAL CALIPERS

DATA OUTPUT



1171-300

- Resolution: 0.01mm/0.0005"
- Buttons: on/off, zero, mm/inch
- Automatic power off, move the digital unit to turn on power
- Battery CR2032
- Data output
- Made of stainless steel
- Optional accessory: data output cable (code 7315-21, 7302-21)

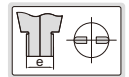
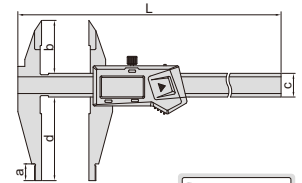

Code	Range	Accuracy	L	a	b	c	d	e
1171-200	0-200mm/0-8"	±0.03mm	320	12	38	17	60	10
1171-306	0-300mm/0-12"	±0.04mm	420	12	38	17	60	10
1171-300	0-300mm/0-12"	±0.06mm	420	12	38	17	90	10

DIGITAL CALIPERS

DATA OUTPUT



1170-300

- Resolution: 0.01mm/0.0005"
- Buttons: on/off, zero, mm/inch
- Automatic power off, move the digital unit to turn on power
- Battery CR2032
- Data output
- Made of stainless steel
- Optional accessory: data output cable (code 7315-21, 7302-21)

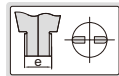
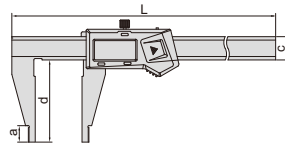

Code	Range	Accuracy	L	a	c	d	e
1170-200	0-200mm/0-8"	±0.03mm	314	12	17	60	10
1170-306	0-300mm/0-12"	±0.04mm	420	12	17	60	10
1170-300	0-300mm/0-12"	±0.06mm	420	12	17	90	10

PLASTIC DIGITAL CALIPER

ATTENTION:
NO DATA OUTPUT



1139-150

- Made of hard plastic, non-magnetic and non electric conductive
- Prevent workpieces from scratching by calipers
- Resolution: 0.01mm/0.0005"
- Buttons: on/off, zero, mm/inch
- Battery CR2032, automatic power off

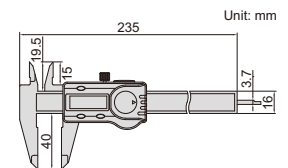

Code	Range	Accuracy
1139-150	0-150mm/0-6"	±0.1mm

DIAL CALIPERS

- Shockproof dial indicator
- Made of stainless steel

INSPECTION CERTIFICATE

SHOCK PROOF



1312-150A

Dial indicator graduation: 0.02mm (mm)

Code	Range	Accuracy	Thumb roller	L	a	b	c	d	D	t
1312-150A*	0-150mm	±0.03mm	with	235	21	16.5	16	40	Ø39	6.5
1312-200A*	0-200mm	±0.03mm	with	288	24	19	16	48	Ø39	6.5
1312-300A*	0-300mm	±0.03mm	with	410	28	22	20	62	Ø44.5	7.5

Dial indicator graduation: 0.01mm (mm)

Code	Range	Accuracy	Thumb roller	L	a	b	c	d	D	t
1311-150A*	0-150mm	±0.03mm	with	235	21	16.5	16	40	Ø39	6.5
1311-200A*	0-200mm	±0.03mm	with	288	24	19	16	48	Ø39	6.5
1311-300A*	0-300mm	±0.03mm	with	410	28	22	20	62	Ø44.5	7.5

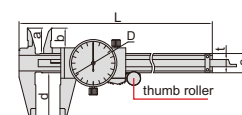

*Supplied with manufacturer inspection certificate

MINI VERNIER CALIPERS

- Meet DIN862
- Made of stainless steel
- Satin chrome plated reading surface

Code	Range	Graduation	Accuracy
1204-70	0-70mm	0.05mm	±0.05mm



1204-70

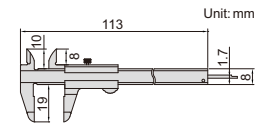

Code	Range	Graduation	Accuracy
1203-1003	0-100mm	0.05mm	±0.05mm



1203-1003

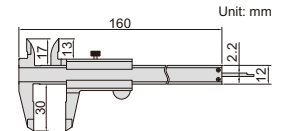

Code	Range	Graduation	Accuracy
1201-1003	0-100mm	0.05mm	±0.05mm



1201-1003

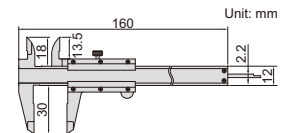

VERNIER CALIPER WITH ROUND DEPTH BAR

- Graduation: 0.05mm/1/128"
- Round depth bar
- Meet DIN862
- Made of stainless steel
- Satin chrome plated reading surface

Code	Range	Accuracy
1202-150	0-150mm/0-6"	±0.05mm



1202-150

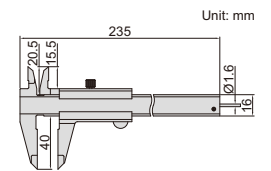

VERNIER CALIPERS (ANTI MAGNETIC)

- Suitable for magnetic parts
- Made of pure copper

ATTENTION:
NOT HARDENED

PURE
COPPER

Code	Range	Graduation	Accuracy
1224-150A	0-150mm	0.02mm	±0.05mm
1224-1501A	0-150mm	0.05mm	±0.05mm



1224-150A

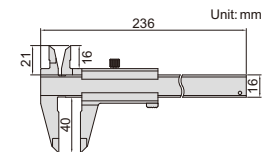

VERNIER CALIPERS

- With fine adjustment
- Made of stainless steel
- Satin chrome plated reading surface

Code	Range	Graduation	Accuracy	L
1217-2503	0-250mm	0.05mm	±0.05mm	360mm
1217-3001	0-300mm	0.02mm	±0.03mm	410mm



1217-3001

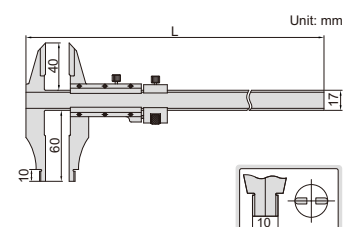

VERNIER CALIPERS

- Meet DIN862
- Made of stainless steel
- Satin chrome plated reading surface



1205-1502S

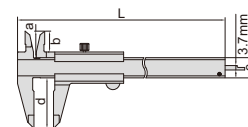

Graduation 0.05mm/1/128" (mm)

Code	Range	Accuracy	L	a	b	c	d
1205-150S	0-150mm/0-6"	±0.05mm	235	20.5	15.5	16	40
1205-200S	0-200mm/0-8"	±0.05mm	290	23.5	19	17	50
1205-300S	0-300mm/0-12"	±0.05mm	414	27.5	22	20	64

Graduation 0.02mm/0.001" (mm)

Code	Range	Accuracy	L	a	b	c	d
1205-1502S	0-150mm/0-6"	±0.03mm	235	20.5	15.5	16	40
1205-2002S	0-200mm/0-8"	±0.03mm	290	23.5	19	17	50
1205-3002S	0-300mm/0-12"	±0.03mm	414	27.5	22	20	64

Graduation 0.05mm (mm)

Code	Range	Accuracy	L	a	b	c	d
1205-1503S	0-150mm	±0.05mm	235	20.5	15.5	16	40
1205-2003S	0-200mm	±0.05mm	290	23.5	19	17	50
1205-3003S	0-300mm	±0.05mm	414	27.5	22	20	64

Graduation 0.02mm (mm)

Code	Range	Accuracy	L	a	b	c	d
1205-1501S	0-150mm	±0.03mm	235	20.5	15.5	16	40
1205-2001S	0-200mm	±0.03mm	290	23.5	19	17	50
1205-3001S	0-300mm	±0.03mm	414	27.5	22	20	64

VERNIER CALIPERS WITH THUMB CLAMP



1223-150

- Meet DIN862
- With thumb clamp
- Made of stainless steel
- Satin chrome plated reading surface

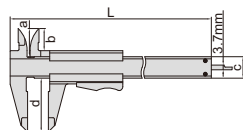

Graduation 0.05mm/1/128" (mm)

Code	Range	Accuracy	L	a	b	c	d
1223-150	0-150mm/0-6"	±0.05mm	230	20.5	16.5	16	40
1223-200	0-200mm/0-8"	±0.05mm	295	23.5	19	16	50

Graduation 0.02mm/0.001" (mm)

Code	Range	Accuracy	L	a	b	c	d
1223-1502	0-150mm/0-6"	±0.03mm	230	20.5	16.5	16	40
1223-2002	0-200mm/0-8"	±0.03mm	295	23.5	19	16	50

LEFT HAND VERNIER CALIPERS



1239-1502

- Designed for left handed users
- Made of stainless steel
- Satin chrome plated reading surface

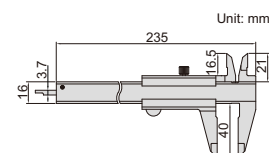

Code	Range	Graduation	Accuracy
1239-150	0-150mm/0-6"	0.05mm/1/128"	±0.05mm
1239-1502	0-150mm/0-6"	0.02mm/0.001"	±0.03mm

DEPTH BASE ATTACHMENTS

- To increase the stability of depth measurement
- Suitable for digital calipers and dial calipers
- Made of stainless steel



6140



6140-16B

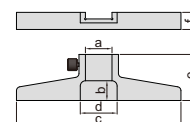

Code	a	b	c	d	e	f	Type	Application
6140	16.5	9	75	18	30	6	narrow base (f=6)	Suitable for calipers with beam width (w) 16mm
6140-300A	20	15	125	22	34	9	narrow base (f=9)	Suitable for calipers with beam width (w) 20mm
6140-16B	16	12.5	75	24.5	30	11	wide base (f=11), high stability	Suitable for calipers with beam width (w) 16mm

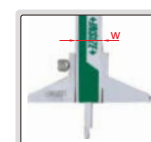

ACCESSORY SET FOR DIGITAL CALIPERS CODE 6144

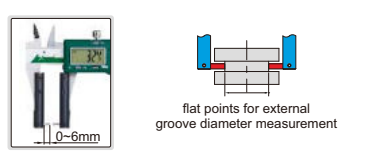
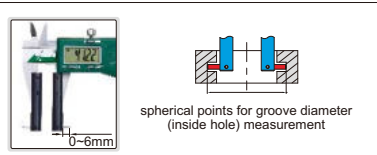
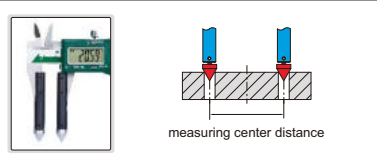
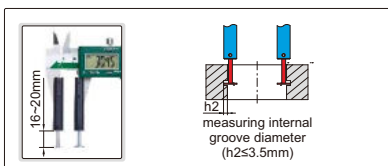
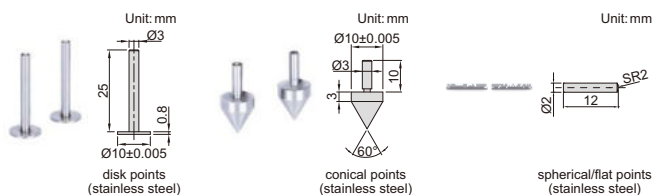

- Suitable for 0-150mm/0-6" and 0-200mm/0-8" digital calipers (thickness of lower jaws ≤ 3.7mm)

Code
6144



ACCESSORY SET FOR LARGE DIGITAL CALIPERS CODE 6145-500

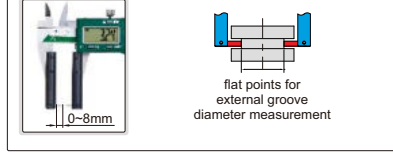
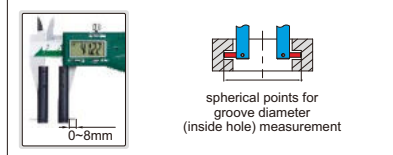
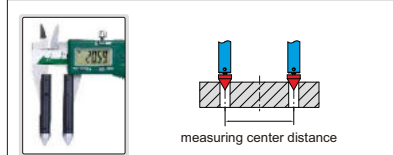
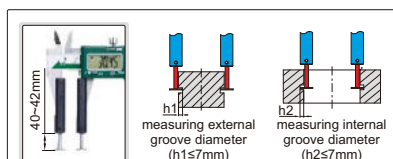
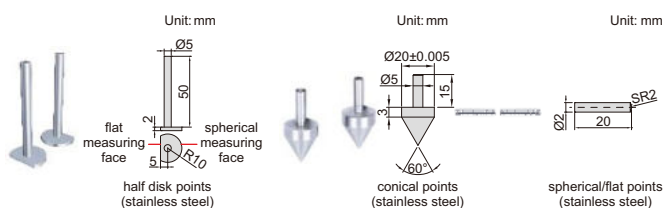

- Suitable for 0-500mm/0-20" and 0-600mm/0-24" digital calipers (thickness of lower jaws ≤ 5.6mm)

Code

6145-500



ACCESSORY SET FOR LARGE DIGITAL CALIPERS (WITH SIDE POINTS) CODE 6146-500B

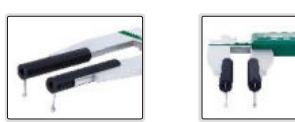
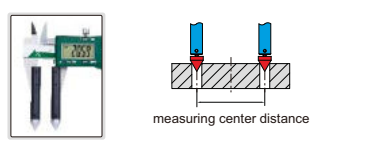
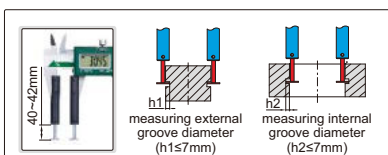
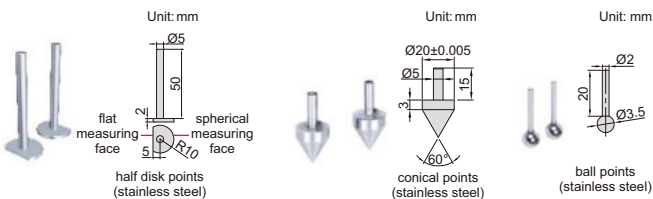

- Suitable for 0-500mm/0-20" and 0-600mm/0-24" digital calipers (thickness of lower jaws ≤ 5.6mm)

Code

6146-500B



DIGITAL CALIPERS

DATA
OUTPUT



1106-501

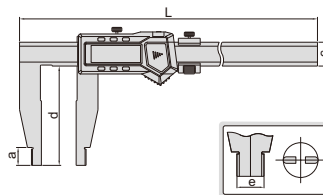

- Resolution: 0.01mm/0.0005"
- Button function: on/off, zero, mm/inch, ABS, data preset
- Battery CR2032
- Data output
- Made of stainless steel
- Optional accessory: data output cable for range ≤ 1000mm (code 7315-22, 7302-22)

Code	Range	Accuracy	a	c	d	e	L
1106-301	0-300mm/0-12"	±0.05mm	18	24	100	20	420
1106-302	0-300mm/0-12"	±0.05mm	18	24	150	20	420
1106-451	0-450mm/0-18"	±0.05mm	18	24	100	20	625
1106-501	0-500mm/0-20"	±0.05mm	18	24	100	20	675
1106-502	0-500mm/0-20"	±0.06mm	18	24	150	20	675
1106-503	0-500mm/0-20"	±0.06mm	24	31	200	20	675
1106-601	0-600mm/0-24"	±0.05mm	18	24	100	20	770
1106-802	0-800mm/0-32"	±0.07mm	24	31	150	20	1025
1106-1002	0-1000mm/0-40"	±0.08mm	24	31	150	20	1220
1106-1502	0-1500mm/0-60"	±0.11mm	24	42	150	20	1780
1106-2002	0-2000mm/0-80"	±0.14mm	24	42	150	20	2290

DIGITAL CALIPERS

DATA
OUTPUT



1135-601

- Resolution: 0.01mm/0.0005"
- Button function: on/off, zero, mm/inch, ABS, data preset
- Battery CR2032
- Data output
- Made of stainless steel
- Optional accessory: data output cable (code 7315-22, 7302-22)

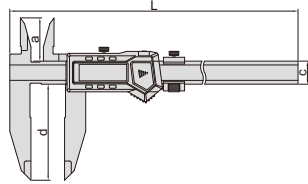

(mm)

Code	Range	Accuracy	a	c	d	L
1135-451	0-450mm/0-18"	±0.05mm	45	24	100	625
1135-601	0-600mm/0-24"	±0.05mm	45	24	100	770
1135-1002	0-1000mm/0-40"	±0.08mm	60	31	150	1220

DIGITAL CALIPERS

DATA
OUTPUT



1136-501

- Resolution: 0.01mm/0.0005"
- Button function: on/off, zero, mm/inch, ABS, data preset
- Battery CR2032
- Data output
- Made of stainless steel
- Optional accessory: data output cable (code 7315-22, 7302-22)

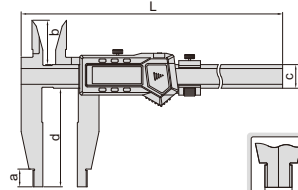

(mm)

Code	Range	Accuracy	a	b	c	d	e	L
1136-301	0-300mm/0-12"	±0.05mm	18	45	24	100	20	420
1136-501	0-500mm/0-20"	±0.05mm	18	45	24	100	20	675
1136-502	0-500mm/0-20"	±0.06mm	18	45	24	150	20	675
1136-601	0-600mm/0-24"	±0.05mm	18	45	24	100	20	770
1136-1002	0-1000mm/0-40"	±0.08mm	24	60	31	150	20	1220

VERNIER CALIPERS (SOLID TYPE)



1236-511

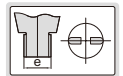
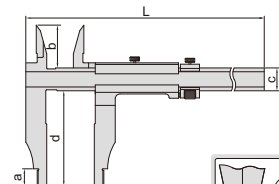

- With fine adjustment
- Made of stainless steel
- Satin chrome plated reading surface

Graduation 0.05mm/1/128"

(mm)

Code	Range	Accuracy	a	b	c	d	e	L
1236-524	0-500mm/0-20"	±0.08mm	18	45	24	150	20	670
1236-614	0-600mm/0-24"	±0.08mm	18	45	24	100	20	770
1236-1024	0-1000mm/0-40"	±0.12mm	24	60	31	150	20	1230

Graduation 0.02mm

(mm)

Code	Range	Accuracy	a	b	c	d	e	L
1236-511	0-500mm	±0.05mm	18	45	24	100	20	670
1236-1021	0-1000mm	±0.08mm	24	60	31	150	20	1230

VERNIER CALIPER (SOLID TYPE)

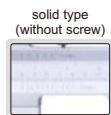

1207-394

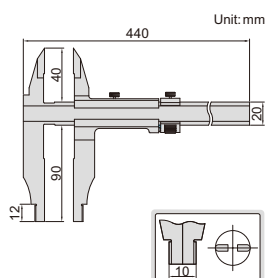

- Graduation 0.05mm/1/128"
- With fine adjustment
- Made of stainless steel
- Satin chrome plated reading surface

Code	Range	Accuracy
1207-394	0-300mm/0-12"	±0.07mm

VERNIER CALIPERS (SEPARATE TYPE)

separate type
(with screws)

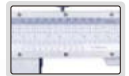

1214-500

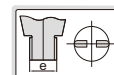
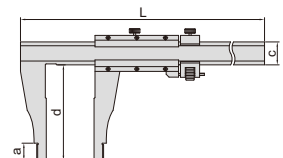

- Graduation 0.02mm/0.001"
- With fine adjustment
- Made of stainless steel
- Satin chrome plated reading surface

(mm)

Code	Range	Accuracy	a	c	d	e	L
1214-300	0-300mm/0-12"	±0.05mm	10	20	75	10	410
1214-450	0-450mm/0-18"	±0.05mm	18	24	100	20	620
1214-500	0-500mm/0-20"	±0.05mm	18	24	100	20	670
1214-600	0-600mm/0-24"	±0.05mm	18	24	100	20	770
1214-1000	0-1000mm/0-40"	±0.08mm	24	32	140	20	1216

VERNIER CALIPERS (SOLID TYPE)

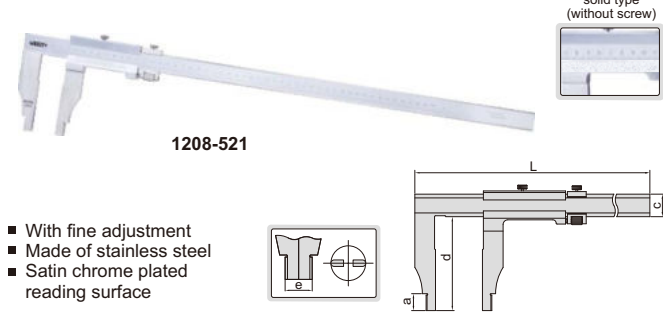

1208-521

- With fine adjustment
- Made of stainless steel
- Satin chrome plated reading surface

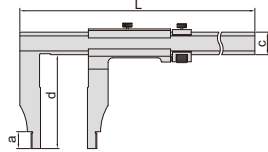
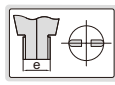

Graduation 0.05mm/1/128" (mm)

Code	Range	Accuracy	a	c	d	e	L
1208-214	0-200mm/0-8"	±0.06mm	10	20	100	10	330
1208-394	0-300mm/0-12"	±0.07mm	10	20	90	10	410
1208-324	0-300mm/0-12"	±0.07mm	18	24	150	20	410
1208-524	0-500mm/0-20"	±0.08mm	18	24	150	20	670
1208-614	0-600mm/0-24"	±0.08mm	18	24	100	20	770
1208-824	0-800mm/0-32"	±0.09mm	24	31	150	20	1030
1208-1024	0-1000mm/0-40"	±0.12mm	24	31	150	20	1230

Graduation 0.02mm (mm)

Code	Range	Accuracy	a	c	d	e	L
1208-521	0-500mm	±0.06mm	18	24	150	20	670
1208-1021	0-1000mm	±0.08mm	24	31	150	20	1230

LONG JAW VERNIER CALIPERS (SEPARATE TYPE)



1215-1034

separate type (with screws)



- With fine adjustment
- Made of stainless steel
- Satin chrome plated reading surface

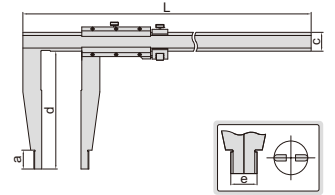

Graduation 0.05mm/1/128" (mm)

Code	Range	Accuracy	a	c	d	e	L
1215-524	0-500mm/0-20"	±0.08mm	18	24	150	20	670
1215-1034	0-1000mm/0-40"	±0.12mm	24	32	200	20	1330

CARBON FIBER COMPARISON GAGES

CARBON FIBER RODS, LIGHT WEIGHT, NOT EASY TO DEFORM, NO TEMPERATURE EXPAND, SUITABLE FOR THIN-WALL WORKPIECES AND LARGE-SIZE WORKPIECES

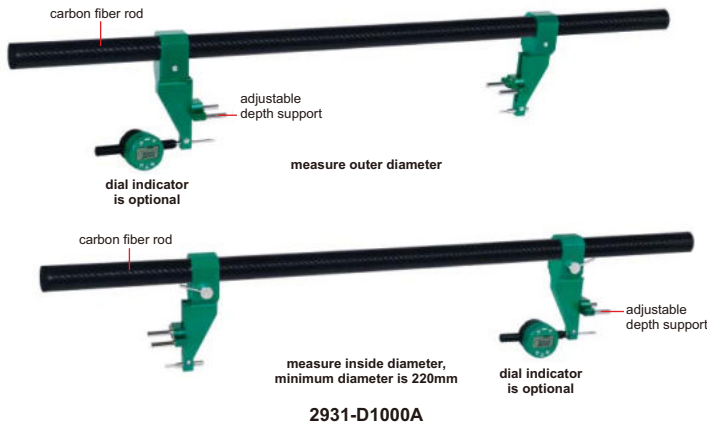

2931-D1000A

- Measure outer diameter, inside diameter, holes distance and cylindrical workpiece length
- Carbon fiber rods, light weight, not easy to deform, no temperature expand
- Optional accessory: cylinder gage blocks (code 4001)

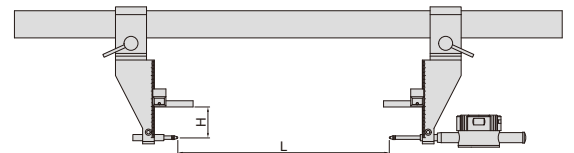

application		

Code	Maximum measuring range (L)	Measuring depth (H)	Repeatability	Weight
2931-D1000A	1000mm	0-100mm	5µm	2.0kg
2931-D1000B	1000mm	0-200mm	10µm	2.3kg
2931-D1000C	1000mm	0-300mm	25µm	2.6kg
2931-D1500A	1500mm	0-100mm	8µm	2.3kg
2931-D1500B	1500mm	0-200mm	15µm	2.6kg
2931-D1500C	1500mm	0-300mm	30µm	2.9kg
2931-D2000A	2000mm	0-100mm	10µm	2.6kg
2931-D2000B	2000mm	0-200mm	20µm	2.9kg
2931-D2000C	2000mm	0-300mm	35µm	3.2kg
2931-D2500A	2500mm	0-100mm	12µm	2.9kg
2931-D2500B	2500mm	0-200mm	25µm	3.2kg
2931-D2500C	2500mm	0-300mm	50µm	3.5kg
2931-D3000A	3000mm	0-100mm	14µm	3.2kg
2931-D3000B	3000mm	0-200mm	30µm	3.5kg
2931-D3000C	3000mm	0-300mm	60µm	3.8kg
2931-D4000A	4000mm	0-100mm	16µm	3.8kg
2931-D4000B	4000mm	0-200mm	35µm	4.1kg
2931-D4000C	4000mm	0-300mm	65µm	4.4kg

UNIVERSAL CALIPER CODE 1125-600



DATA
OUTPUT



1125-600

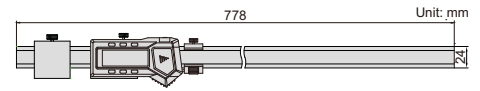

- Buttons: on/off, set, mm/inch, ABS, preset (+, -)
- Automatic power off, move the digital unit to turn on power
- Battery CR2032
- Data output
- Made of stainless steel
- Optional accessory: data output cable (code 7315-22, 7302-22)

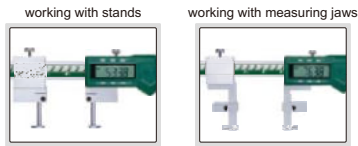

Code	Range*	Resolution	Accuracy
1125-600	0-600mm/0-24"	0.01mm/0.0005"	±0.05mm

*The range changes according to different points

Half disk points (included)

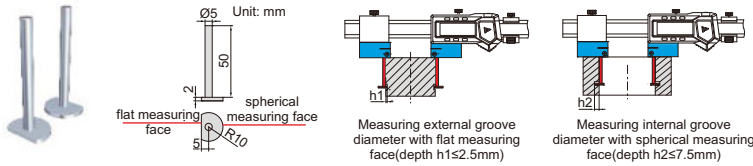

Depth stop (included)

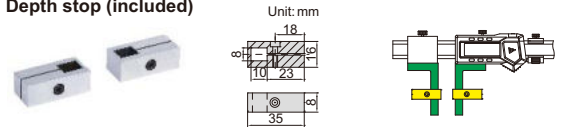

Round shoulder points (optional)

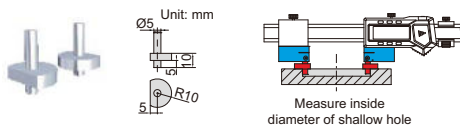

Code
1125-T102

Conical points (optional)

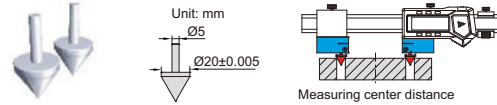

Code
1125-T101

Spherical points (included)

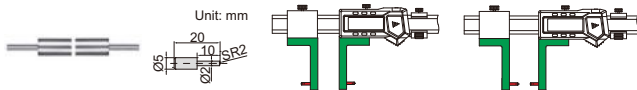

Flat shoulder points (optional)

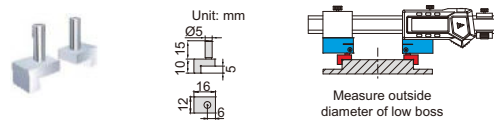

Code
1125-T103

Stands (included)

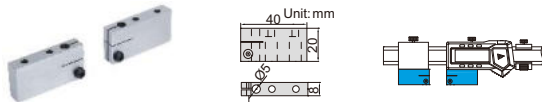

Point sleeve (optional)

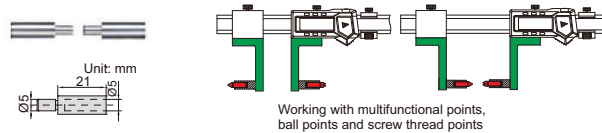

Code
1125-T104

Measuring jaws (included)

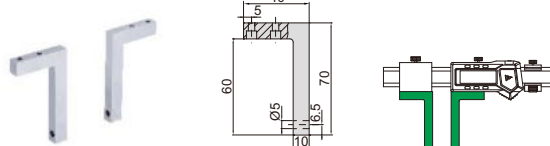

Multifunctional points 7392* (optional)



Ball points 7391* (optional)



Screw thread points 7381*, 7321* (optional)



*It is necessary to use point sleeve (code 1125-T104) for these points

DIGITAL CALIPER WITH INTERCHANGEABLE POINTS CODE 1526-200

DATA
OUTPUT



1526-200

short spherical points (included)

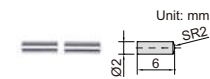

long spherical/flat points (included)



spherical blade points (included)

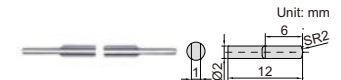

preset buttons

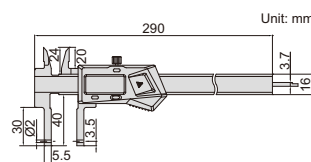

- Supplied with 3 pairs of points and zero setting block for external measurement
- Resolution: 0.01mm/0.0005"
- Buttons: on/off, set, mm/inch, preset (+, -)
- Automatic power off, move the digital unit to turn on power
- Battery CR2032
- Data output
- Made of stainless steel
- Optional accessory: points, data output cable (code 7315-21, 7302-21)

Point	Range	Accuracy	Application
short spherical points	12-212mm/0.5-8.5"(internal)	±0.03mm	for grooves inside small hole
long spherical/flat points	24-224mm/1-8.8"(internal) 0-187mm/0-7.5"(external)	±0.03mm	spherical points for grooves inside hole flat points for external grooves
spherical blade points	24-224mm/1-8.8"(internal) 0-187mm/0-7.5"(external)	±0.03mm	for narrow grooves inside hole

To be continued

Continued from previous page

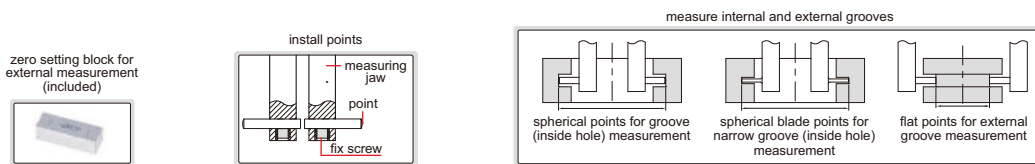

Depth stop (optional)

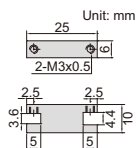

6143

Code
6143

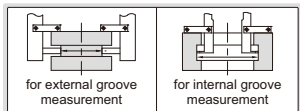

Point sleeve (optional)



1526-T101

Code
1526-T101

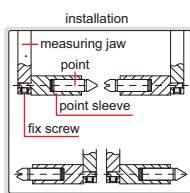
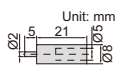

Ball points (optional)



7391-T5

Code	Ball dia. (D)
7391-T3 *	SØ2.0mm
7391-T4 *	SØ2.5mm
7391-T5 *	SØ3.0mm
7391-T6 *	SØ3.5mm
7391-T7 *	SØ4.0mm
7391-T8 *	SØ4.5mm
7391-T9 *	SØ5.0mm
7391-T10 *	SØ6.0mm

* It is necessary to use point sleeve (code 1526-T101) for these points

Multifunctional points (optional)

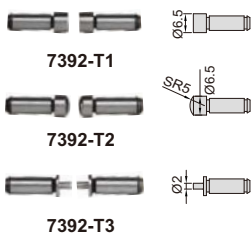

7392-T3

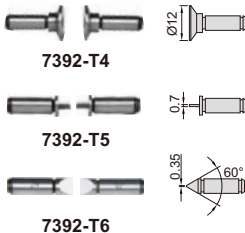

7392-T6

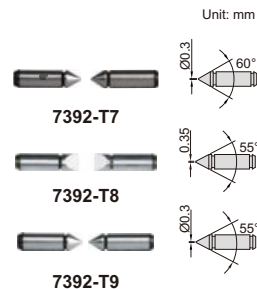

7392-T9

Code	Type
7392-T1 *	flat
7392-T2 *	spherical
7392-T3 *	spline

Code	Type
7392-T4 *	disk
7392-T5 *	blade
7392-T6 *	knife-edge

Code	Type
7392-T7 *	point
7392-T8 *	knife-edge
7392-T9 *	point

* It is necessary to use point sleeve (code 1526-T101) for these points

Screw thread points (optional)

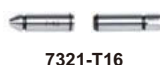

7321-T16

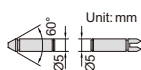

Internal thread (60° thread angle)

Code	Pitch
7321-T11 *	0.4-0.5mm/64-48TPI
7321-T12 *	0.6-0.9mm/44-28TPI
7321-T13 *	1-1.75mm/24-14TPI
7321-T14 *	2-3mm/13-9TPI
7321-T15 *	3.5-5mm/8-5TPI
7321-T16 *	5.5-7mm/4.5-3.5TPI
7321-T1S *	6 pairs/set, including all above points



7381-T11

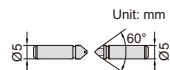

External thread (60° thread angle)

Code	Pitch
7381-T11 *	0.4-0.5mm/64-48TPI
7381-T12 *	0.6-0.9mm/44-28TPI
7381-T13 *	1-1.75mm/24-14TPI
7381-T14 *	2-3mm/13-9TPI
7381-T15 *	3.5-5mm/8-5TPI
7381-T16 *	5.5-7mm/4.5-3.5TPI
7381-TS *	6 pairs/set, including all above points

* It is necessary to use point sleeve (code 1526-T101) for these points

DIGITAL CALIPER WITH INTERCHANGEABLE POINTS CODE 1124-300A



DATA
OUTPUT

short spherical/flat points (included)



long spherical/flat points (included)



short spherical blade points (included)

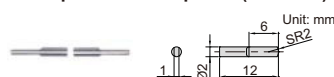

long spherical blade points (included)

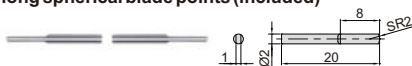

1124-300A

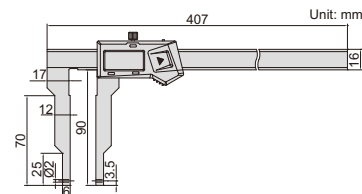

depth stop 6143
(optional)



preset buttons



zero setting block for
external measurement
(included)



install points

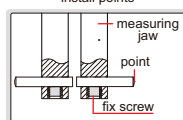

measure internal and external grooves

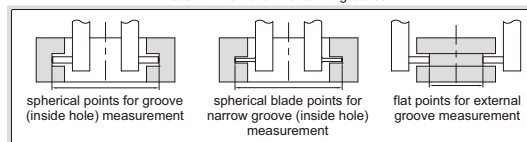

- Supplied with 4 pairs of points and zero setting block for external measurement
- Resolution: 0.01mm/0.0005"
- Buttons: on/off, set, mm/inch, preset (+, -)
- Automatic power off, move the digital unit to turn on power
- Battery CR2032
- Data output
- Made of stainless steel
- Optional accessory: points (code 1526-T101, 7392, 7391, 7381, 7321), depth stop (code 6143), data output cable (code 7315-21, 7302-21)

Point	Range	Accuracy	Application
short spherical/flat points	24-324mm/1-12.7"(internal) 0-288mm/0-11.3"(external)	±0.04mm	spherical points for grooves inside hole (small hole) flat points for external grooves
long spherical/flat points	40-340mm/1.5-13.3"(internal) 0-272mm/0-10.7"(external)	±0.04mm	spherical points for grooves inside hole (large hole) flat points for external grooves
short spherical blade points	24-324mm/1-12.7"(internal) 0-288mm/0-11.3"(external)	±0.04mm	for narrow grooves inside hole (small hole)
long spherical blade points	40-340mm/1.5-13.3"(internal) 0-272mm/0-10.7"(external)	±0.04mm	for narrow grooves inside hole (large hole)

Multifunctional points 7392* (optional)



Ball points 7391* (optional)



Screw thread points 7381*, 7321* (optional)



* It is necessary to use point sleeve (code 1526-T101) for these points

DIGITAL CALIPER WITH INTERCHANGEABLE POINTS



VARIOUS POINTS
ARE AVAILABLE

DATA
OUTPUT



1530-300

- Supplied with 4 pairs of points and zero setting block for external measurement
- Resolution: 0.01mm/0.0005"
- Buttons: on/off, set, mm/inch, preset (+, -)
- Automatic power off, move the digital unit to turn on power
- Battery CR2032
- Data output
- Made of stainless steel
- Optional accessory: points, depth stop (code 6143), data output cable (code 7315-21, 7302-21)

preset buttons

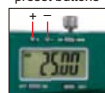

depth stop 6143
(optional)



zero setting block for
external measurement
(included)

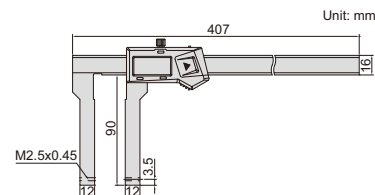
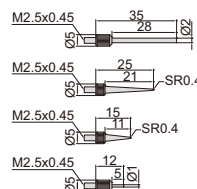

4 pairs of points (included)

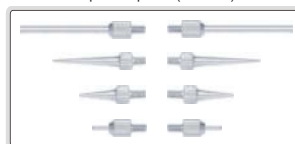

measure internal and external grooves

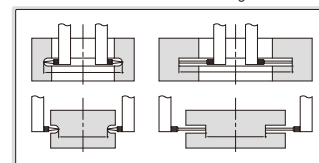

Code	Range*	Accuracy
1530-300	0-300mm/0-12"	±0.04mm

*For different points, the measuring range changes accordingly

DIGITAL INSIDE GROOVE CALIPERS

- Measure diameter of grooves inside small bores
- Resolution: 0.01mm/0.0005"
- Buttons type A: on/off, set, mm/inch, preset (+, -), type B: on/off, zero, mm/inch, ABS/REL, hold
- Battery CR2032
- Made of stainless steel
- Optional accessory: depth stop (code 6143)

No dust/waterproof, with data interface
(data output cable code 7315-21, 7302-21, optional)

Code	Range	Type	Accuracy
1520-150	11-150mm/0.43-6"	A	±0.04mm

IP67 dust/waterproof, without data interface, no automatic power off, set zero after power on each time

Code	Range	Type	Accuracy
1520-150P	14-150mm/0.56-6"	B	±0.04mm

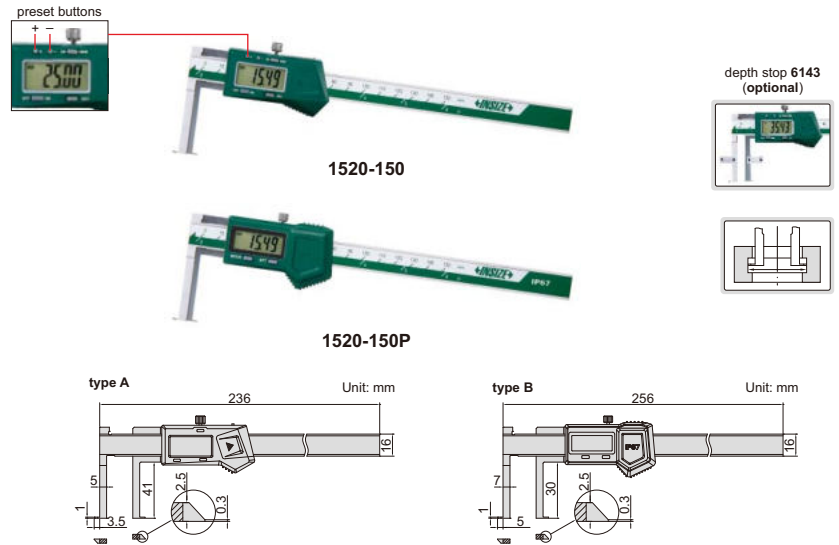

DIGITAL INSIDE GROOVE CALIPERS

- Measure groove diameter
- Resolution: 0.01mm/0.0005"
- Buttons type A: on/off, set, mm/inch, preset (+, -), type C: on/off, zero, mm/inch, ABS/REL, hold
- Battery CR2032
- Made of stainless steel
- Optional accessory: depth stop (code 6143, for calipers with c=16mm)

No dust/waterproof, with data interface, preset (no need to add the width of the jaws on the reading) (mm)

Code	Range	Type	Accuracy	L	a	b	c	d	e	Data output cable (optional)
1120-150A	22-150mm/0.87-6"	A	±0.04mm	250	5	11	16	30	1	7315-21, 7302-21
1120-1501	35-150mm/1.38-6"	A	±0.06mm	250	6	17.5	16	60	1.5	7315-21, 7302-21
1120-200A	25-200mm/0.98-8"	A	±0.04mm	310	5	12.5	16	40	1	7315-21, 7302-21
1120-2001	40-200mm/1.57-8"	A	±0.06mm	310	7	20	16	70	2.5	7315-21, 7302-21
1120-300A	30-300mm/1.18-12"	A	±0.05mm	410	5	15	16	50	1.5	7315-21, 7302-21
1120-3001	50-300mm/1.97-12"	A	±0.07mm	410	8	25	16	80	2.5	7315-21, 7302-21
1120-500	40-500mm/1.57-20"	A	±0.07mm	680	5	20	24	90	2.2	7315-22, 7302-22

IP67 dust/waterproof, without data interface, no automatic power off, set zero after power on each time, no preset (no need to add the width of the jaws on the reading) (mm)

Code	Range	Type	Accuracy	L	a	b	c	d	e
1120-150P	22-150mm/0.87-6"	C	±0.04mm	250	5	11	16	30	1

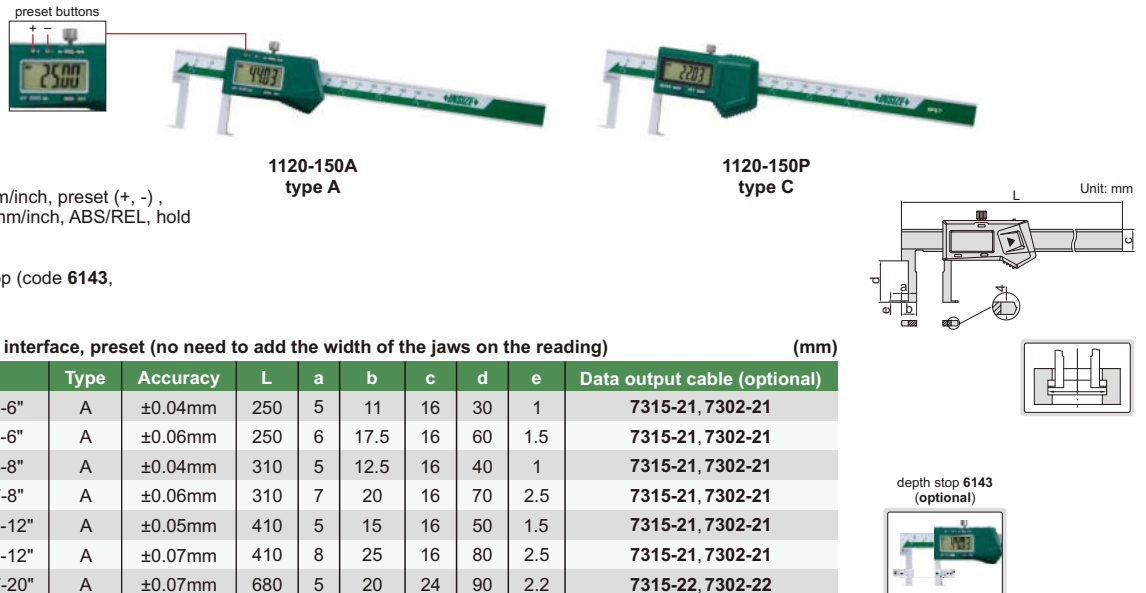

DIGITAL INSIDE POINT CALIPERS

- Measure groove diameter
- Resolution: 0.01mm/0.0005"
- Buttons: on/off, set, mm/inch, preset (+, -)
- Automatic power off, move the digital unit to turn on power
- Battery CR2032, data output
- Made of stainless steel
- Optional accessory: depth stop (code 6143, for calipers with c=16mm)



1121-150A

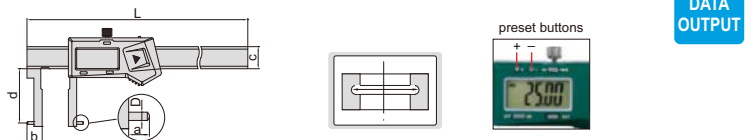

With data interface, preset (no need to add the width of the jaws on the reading) (mm)

Code	Range	Accuracy	L	a	b	c	d	D	Data output cable (optional)
1121-150A	24-150mm/0.94-6"	±0.04mm	250	5	12	16	28	∅2	7315-21, 7302-21
1121-1501	35-150mm/1.38-6"	±0.05mm	250	6	17.5	16	60	∅2	7315-21, 7302-21
1121-200A	25-200mm/0.98-8"	±0.04mm	310	5	12.5	16	37	∅2	7315-21, 7302-21
1121-2001	40-200mm/1.57-8"	±0.05mm	310	7	20	16	70	∅3	7315-21, 7302-21
1121-300A	30-300mm/1.18-12"	±0.07mm	410	5	15	16	50	∅2	7315-21, 7302-21
1121-3001A	50-300mm/1.97-12"	±0.07mm	410	8	25	16	77	∅3	7315-21, 7302-21
1121-500A	40-500mm/1.57-20"	±0.07mm	680	5	20	24	90	∅3	7315-22, 7302-22

INSIDE GROOVE VERNIER CALIPER

- Measure diameter of grooves inside bores
- Made of stainless steel
- Satin chrome plated reading surface



1262-150A

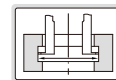
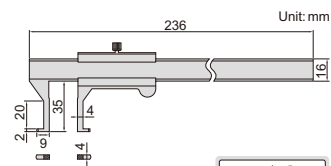

Code	Range	Graduation	Accuracy
1262-150A	18-150mm	0.02mm	±0.04mm

DIGITAL INSIDE GROOVE CALIPERS

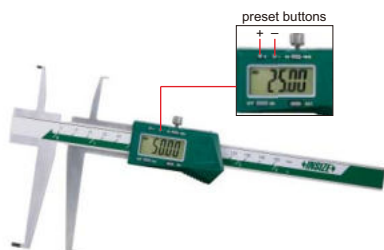

1176-150

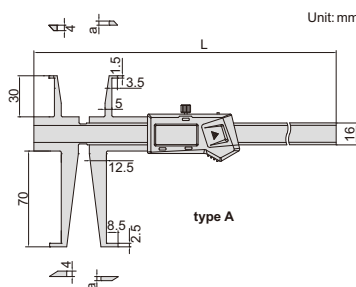

type A

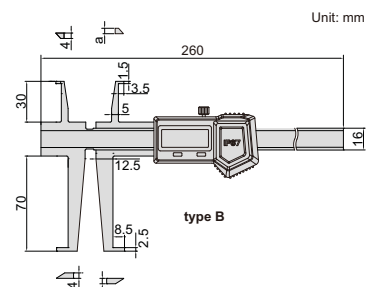

type B



1176-150P



depth stop 6143 (optional)

sizes to be measured (use upper jaws)

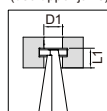

D1	L1
Ø9	<8
Ø10	<15
Ø11-200	<30

sizes to be measured (use lower jaws)

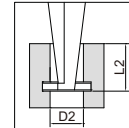

(mm)	
D2	L2
Ø17	<16
Ø18	<28
Ø19	<40
Ø20	<50
Ø21	<58
Ø22-200	<70

No dust/waterproof, with data interface (data output cable code 7315-21, 7302-21, optional)

Code	Range of upper jaw	Range of lower jaw	Type	Accuracy	L	a
1176-150	9-150mm/0.35-6"	17-150mm/0.70-6"	A	±0.04mm	260mm	3mm
1176-200	9-200mm/0.35-8"	17-200mm/0.70-8"	A	±0.05mm	320mm	3.5mm

- Measure diameter of grooves inside bores
- Resolution: 0.01mm/0.0005"
- Buttons type A: on/off, set, mm/inch, preset (+, -), type B: on/off, zero, mm/inch, ABS/REL, hold
- Battery CR2032
- Made of stainless steel
- Optional accessory: depth stop (code 6143)

IP67 dust/waterproof, without data interface, no automatic power off, set zero after power on each time

Code	Range of upper jaw	Range of lower jaw	Type	Accuracy	a
1176-150P	9-150mm/0.35-6"	17-150mm/0.70-6"	B	±0.04mm	4mm

INSIDE GROOVE CALIPER



depth stop 6143 (optional)



1199-150

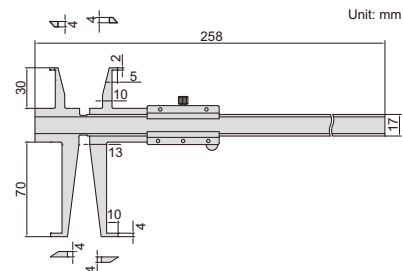

sizes to be measured (use upper jaws)

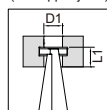

D1	L1
Ø11	<8
Ø12	<10
Ø13	<15
Ø14	<20
Ø15-150	<30

sizes to be measured (use lower jaws)

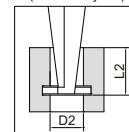

(mm)	
D2	L2
Ø18	<20
Ø19	<28
Ø20	<35
Ø21	<40
Ø22	<50
Ø23-150	<70

- Measure diameter of grooves inside bores
- Graduation: 0.02mm
- Made of stainless steel
- Optional accessory: depth stop (code 6143)

Code	Range of upper jaw	Range of lower jaw	Accuracy
1199-150	11-150mm	18-150mm	±0.03mm

DIGITAL DEEP HOLE INSIDE GROOVE CALIPER

DATA OUTPUT

- Measure diameter of grooves inside deep holes
- Resolution: 0.01mm/0.0005"
- Buttons: on/off, set, mm/inch, preset (+, -)
- Automatic power off, move the digital unit to turn on power
- Battery CR2032
- Data output
- Made of stainless steel
- Optional accessory: depth stop (code 6143), data output cable (code 7315-21, 7302-21)



1129-300

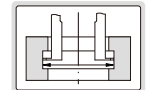
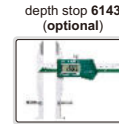
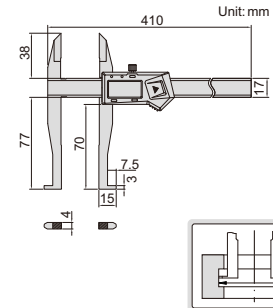

Code	Range of upper jaw	Range of lower jaw	Accuracy
1129-300	0-300mm/0-12"	30-300mm/1.2-12"	±0.04mm

DIGITAL INSIDE GROOVE CALIPERS

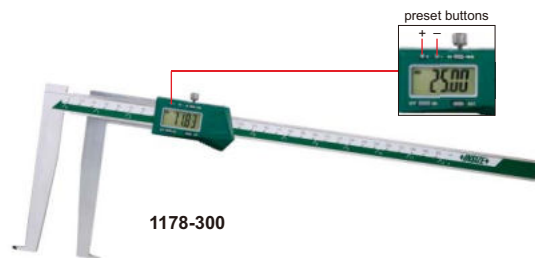

1178-300



1178-300P

- Measure diameter of grooves inside bores
- Resolution: 0.01mm/0.0005"
- Buttons type A: on/off, set, mm/inch, preset (+, -), type B: on/off, zero, mm/inch, ABS/REL, hold
- Battery CR2032
- Made of stainless steel
- Optional accessory: depth stop (code 6143)

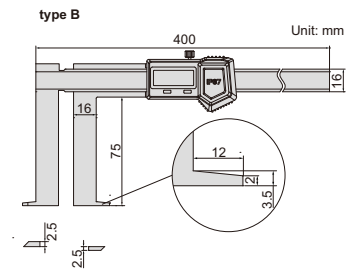
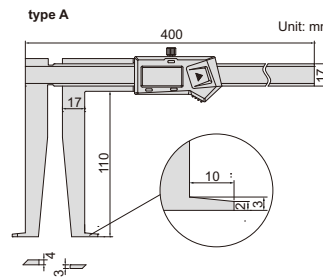

No dust/waterproof, with data interface (data output cable code 7315-21, 7302-21, optional)

Code	Range	Type	Accuracy
1178-300	25-300mm/1.18-12"	A	±0.05mm

IP67 dust/waterproof, without data interface, no automatic power off, set zero after power on each time

Code	Range	Type	Accuracy
1178-300P	33-300mm/1.30-12"	B	±0.05mm

DIGITAL INSIDE GROOVE CALIPER

DATA OUTPUT



1128-200

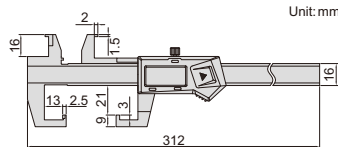

- Measure distance of grooves
- Resolution: 0.01mm/0.0005"
- Buttons: on/off, set, mm/inch, preset (+, -)
- Automatic power off, move the digital unit to turn on power
- Battery CR2032
- Data output
- Made of stainless steel
- Optional accessory: data output cable (code 7315-21, 7302-21)

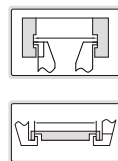
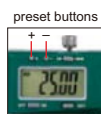

Code	Range of upper jaw	Range of lower jaw	Accuracy
1128-200	10-200mm/0.39-8"	3-200mm/0.12-8"	±0.03mm

DIGITAL INSIDE GROOVE CALIPER

DATA OUTPUT



1191-150

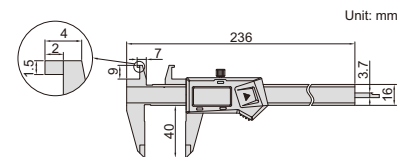

- Upper jaws for measuring diameter of grooves
- Resolution: 0.01mm/0.0005"
- Buttons: on/off, zero, mm/inch
- Automatic power off, move the digital unit to turn on power
- Battery CR2032
- Data output
- Made of stainless steel
- Optional accessory: data output cable (code 7315-21, 7302-21)

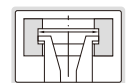

Code	Range of upper jaw	Range of lower jaw	Accuracy
1191-150	8-150mm/0.3-6"	0-150mm/0-6"	±0.03mm

DIGITAL OUTSIDE NECK CALIPER

DATA
OUTPUT



1187-150A

- Measure grooves and recesses
- Resolution: 0.01mm/0.0005"
- Buttons: on/off, zero, mm/inch
- Automatic power off, move the digital unit to turn on power
- Battery CR2032, data output
- Made of stainless steel
- Optional accessory: depth stop (code 6143), data output cable (code 7315-21, 7302-21)

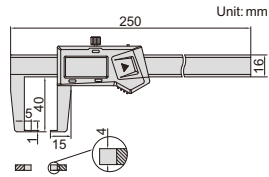

depth stop 6143
(optional)



Code	Range	Accuracy
1187-150A	0-150mm/0-6"	±0.04mm

DIGITAL OUTSIDE POINT CALIPER

DATA
OUTPUT



1185-150A

- Measure wall thickness inside bores and recesses
- Resolution: 0.01mm/0.0005"
- Buttons: on/off, zero, mm/inch
- Automatic power off, move the digital unit to turn on power
- Battery CR2032
- Data output
- Made of stainless steel
- Optional accessory: depth stop (code 6143), data output cable (code 7315-21, 7302-21)

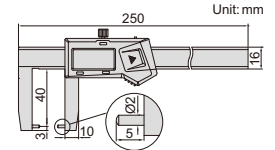

depth stop 6143
(optional)



Code	Range	Accuracy
1185-150A	0-150mm/0-6"	±0.04mm

DEPTH STOP FOR CALIPERS



6143

- Supplied in pairs
- Made of stainless steel
- Suitable for caliper series 1124, 1526, 1530, 1520, 1176, 1178, 1120, 1121, 1187, 1129 and 1185

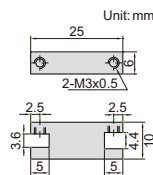

application

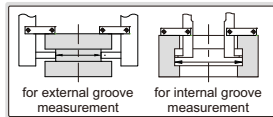

Code
6143



DIGITAL BLADE CALIPER

DATA
OUTPUT



1188-150A

- The blade jaws fit into small grooves
- Resolution: 0.01mm/0.0005"
- Buttons: on/off, zero, mm/inch
- Automatic power off, move the digital unit to turn on power
- Battery CR2032, data output
- Made of stainless steel
- Optional accessory: data output cable (code 7315-21, 7302-21)

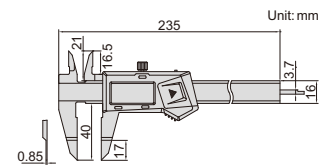

Code	Range	Accuracy
1188-150A	0-150mm/0-6"	±0.03mm

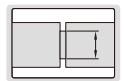

DIGITAL SMALL POINT CALIPER

DATA
OUTPUT



1169-150

- Small pointed jaws fit into small grooves and recesses
- Resolution: 0.01mm/0.0005"
- Buttons: on/off, zero, mm/inch
- Automatic power off, move the digital unit to turn on power
- Battery CR2032, data output
- Made of stainless steel
- Optional accessory: data output cable (code 7315-21, 7302-21)

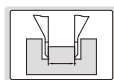
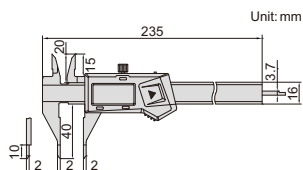

Code	Range	Accuracy
1169-150	0-150mm/0-6"	±0.03mm

DIGITAL POINT CALIPER

DATA
OUTPUT



1183-150A

- Pointed jaws fit into small grooves and recesses
- Resolution: 0.01mm/0.0005"
- Buttons: on/off, zero, mm/inch
- Automatic power off, move the digital unit to turn on power
- Battery CR2032, data output
- Made of stainless steel
- Optional accessory: data output cable (code 7315-21, 7302-21)

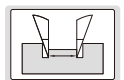
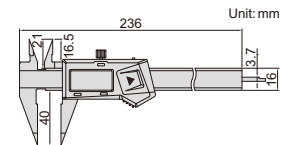

Code	Range	Accuracy
1183-150A	0-150mm/0-6"	±0.03mm

DIGITAL CALIPER WITH KNIFE-EDGE LOWER JAWS

DATA OUTPUT



1532-200

- Measure diameter of narrow grooves
- Resolution: 0.01mm/0.0005"
- Buttons: on/off, zero, mm/inch
- Automatic power off, move the digital unit to turn on power
- Battery CR2032
- Data output
- Made of stainless steel
- Optional accessory: data output cable (code 7315-21, 7302-21)

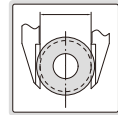
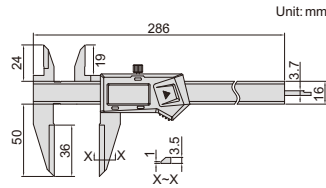

Code	Range	Accuracy
1532-200	0-200mm/0-8"	±0.03mm

DIGITAL INSIDE KNIFE-EDGE CALIPER

DATA OUTPUT



1123-150A

- Measure diameter of deep step holes
- Resolution: 0.01mm/0.0005"
- Buttons: on/off, zero, mm/inch
- Automatic power off, move the digital unit to turn on power
- Battery CR2032, data output
- Made of stainless steel
- Optional accessory: data output cable (code 7315-21, 7302-21)

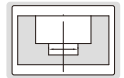
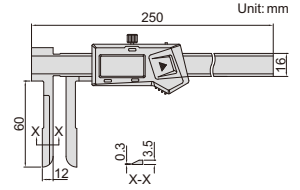

Code	Range	Accuracy
1123-150A	15-150mm/0.6-6"	±0.05mm

DIGITAL CALIPER WITH LONG UPPER JAWS

DATA OUTPUT



1138-200

- Long upper jaws for measuring diameter of deep holes
- Resolution: 0.01mm/0.0005"
- Buttons: on/off, zero, mm/inch
- Automatic power off, move the digital unit to turn on power
- Battery CR2032
- Data output
- Made of stainless steel
- Optional accessory: data output cable (code 7315-21, 7302-21)

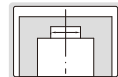
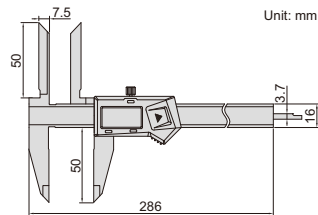

Code	Range	Accuracy
1138-200	0-200mm/0-8"	±0.04mm

DIGITAL OFFSET CENTERLINE CALIPER

DATA OUTPUT



1192-150A

- Measure hole center distance in the same or offset planes
- Resolution: 0.01mm/0.0005"
- Buttons: on/off, set, mm/inch, preset (+, -)
- Automatic power off, move the digital unit to turn on power
- Battery CR2032, data output
- Made of stainless steel
- Optional accessory: data output cable (code 7315-21, 7302-21)

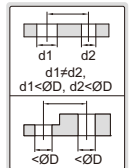
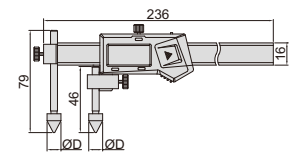

Code	Range	Accuracy	ØD
1192-150A	10-150mm/0.4-6"	±0.05mm	10mm

DIGITAL BACK-JAW CENTERLINE CALIPERS

DATA OUTPUT

- Measure hole center distance in the same or offset planes
- Resolution: 0.01mm/0.0005"
- Buttons: on/off, set, mm/inch, preset (+, -)
- Automatic power off, move the digital unit to turn on power
- Battery CR2032
- Data output
- Made of stainless steel



1177-200

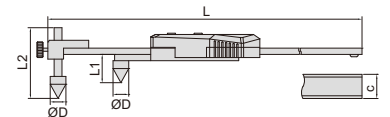

(mm)

Code	Range	Accuracy	ØD	c	L1	L2	L	Data output cable (optional)
1177-200	10-200mm/0.4-8"	±0.10mm	10	16	18	45	310	7315-21, 7302-21
1177-300	10-300mm/0.4-12"	±0.10mm	10	16	18	45	410	7315-21, 7302-21
1177-500	20-500mm/0.8-20"	±0.10mm	20	24	26	70	692	7315-22, 7302-22
1177-1000	30-1000mm/1.2-40"	±0.12mm	30	31	39	70	1242	7315-22, 7302-22
1177-1500	30-1500mm/1.2-60"	±0.15mm	30	31	39	70	1745	7315-22, 7302-22

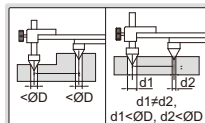

DIGITAL CENTERLINE AND EDGE TO CENTER CALIPERS

DATA OUTPUT

- Measure hole center distance or edge to hole center distance
- Resolution: 0.01mm/0.0005"
- Buttons: on/off, set, mm/inch, preset (+, -)
- Automatic power off, move the digital unit to turn on power
- Battery CR2032, data output
- Made of stainless steel



1525-300

(mm)

Code	Range of upper jaw (edge to center)	Range of lower jaw (center to center)	Accuracy	ØD	L1	L2	c	L	Data output cable (optional)
1525-300	5-300mm/0.2-12"	10-300mm/0.4-12"	±0.08mm	10	44.5	55	17	410	7315-21, 7302-21
1525-500	10-500mm/0.4-20"	20-500mm/0.8-20"	±0.09mm	20	50	60	24	690	7315-22, 7302-22
1525-1000	15-1000mm/0.6-40"	30-1000mm/1.2-40"	±0.12mm	30	70	81	31	1255	7315-22, 7302-22
1525-1500	15-1500mm/0.6-60"	30-1500mm/1.2-60"	±0.15mm	30	70	81	31	1760	7315-22, 7302-22

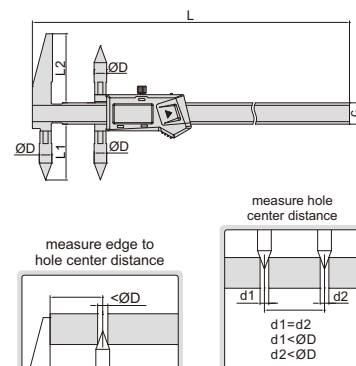

DIGITAL BACK-JAW EDGE TO CENTER CALIPERS

DATA OUTPUT

- Measure edge to hole center distance
- Resolution: 0.01mm/0.0005"
- Buttons: on/off, set, mm/inch, preset (+, -)
- Automatic power off, move the digital unit to turn on power
- Battery CR2032
- Data output
- Made of stainless steel
- Optional accessory: data output cable (code 7315-21, 7302-21)



1524-200

Code	Range	Accuracy	L
1524-200	5-200mm/0.2-8"	±0.1mm	310mm
1524-300	5-300mm/0.2-12"	±0.1mm	410mm

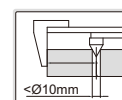
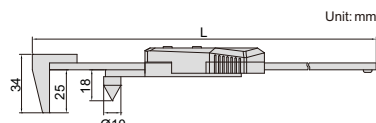

DIGITAL HOOK CALIPER

DATA OUTPUT

- Measure width and distance of grooves inside bores
- Resolution: 0.01mm/0.0005"
- Buttons: on/off, zero, mm/inch
- Automatic power off, move the digital unit to turn on power
- Battery CR2032
- Data output
- Made of stainless steel
- Optional accessory: data output cable (code 7315-21, 7302-21)



1122-300

Code	Range	Accuracy
1122-300	4-300mm/0.16-12"	±0.04mm

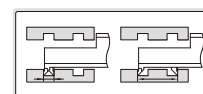
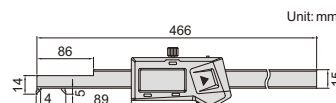

DIGITAL ARC RADIUS CALIPERS

DATA OUTPUT



1189-150B

- Measure the radius of arc less than half round
- Resolution: 0.01mm/0.0005"
- Buttons: on/off, zero, mm/inch
- Automatic power off, move the digital unit to turn on power
- Battery CR2032
- Data output
- Made of stainless steel
- Optional accessory: data output cable (code 7315-21, 7302-21)

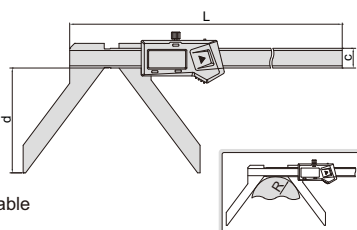

Code	Range (R)	Accuracy	L	c	d
1189-150B	5-150mm/0.2-6"	±0.05mm	263mm	16mm	65mm
1189-200B	5-200mm/0.2-8"	±0.07mm	313mm	16mm	85mm

DIGITAL OFFSET CALIPERS

DATA OUTPUT



1186-150A

- The left jaw can slide up and down to facilitate measurement of stepped sections
- Resolution: 0.01mm/0.0005"
- Buttons: on/off, zero, mm/inch
- Automatic power off, move the digital unit to turn on power
- Battery CR2032, data output
- Made of stainless steel
- Optional accessory: data output cable (code 7315-21, 7302-21)

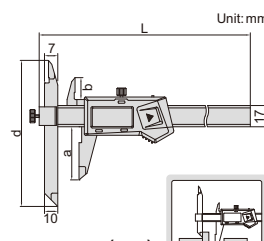

Code	Range	Accuracy	L	a	b	d
1186-150A	0-150mm/0-6"	±0.04mm	249	40	16.5	110
1186-300A	0-300mm/0-12"	±0.05mm	399	60	20.5	130

DIGITAL TUBE THICKNESS CALIPER

DATA OUTPUT

- Measure wall thickness of tubes
- Resolution: 0.01mm/0.0005"
- Buttons: on/off, zero, mm/inch
- Automatic power off, move the digital unit to turn on power
- Battery CR2032, data output
- Made of stainless steel
- Optional accessory: data output cable (code 7315-21, 7302-21)



1161-150A

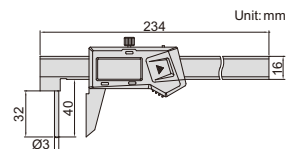

Code	Range	Accuracy
1161-150A	0-150mm/0-6"	±0.05mm

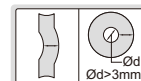

DIGITAL RTJ RING GROOVE CALIPERS

DATA OUTPUT

- Measure ring grooves of flange
- Resolution: 0.01mm/0.0005"
- Button function: on/off, set, zero, mm/inch, data preset
- Battery CR2032, data output
- Made of stainless steel



1179-300 type A



1179-600 type B

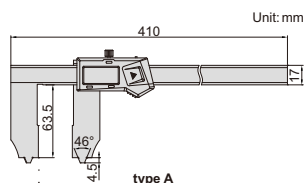

type A

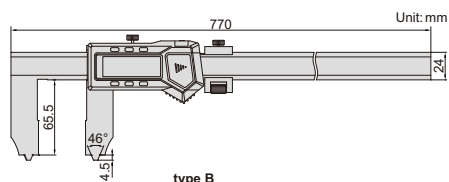

type B

measure outside diameter of RTJ ring groove

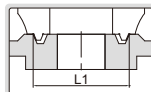

measure inside diameter of RTJ ring groove

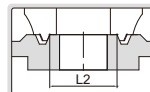

applicable for RTJ ring grooves with angle 23°

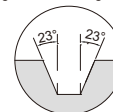

10mm and 25mm need to be added on the reading

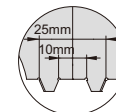

Code	Range (inside diameter of RTJ ring groove)	Range (outside diameter of RTJ ring groove)	Angle of RTJ ring groove	Accuracy	Type	Data output cable (optional)
1179-300	10-300mm/0.4-12"	25-300mm/1-12"	23°	±0.06mm	A	7315-21, 7302-21
1179-600	10-600mm/0.4-24"	25-600mm/1-24"	23°	±0.07mm	B	7315-22, 7302-22

DIGITAL CALIPER WITH INTERCHANGEABLE BALL TIPS

DATA OUTPUT

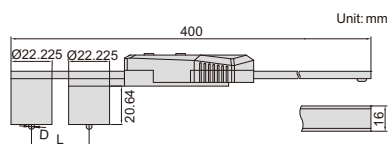

1527-3001

Ball tips (optional, supplied in pair)

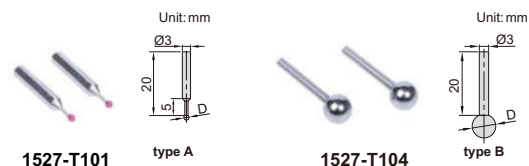

1527-T101 type A

1527-T104 type B

- Resolution 0.01mm/.0005"
- Buttons: on/off, set, mm/inch, preset (+, -)
- Automatic power off, move the digital unit to turn on power
- Battery CR2032, data output
- Made of stainless steel
- Optional accessory: ball tips, data output cable (code 7315-21, 7302-21)

Code	Range	Accuracy
1527-3001	(22.22+D)~300mm*	±0.03mm

*"D" is the diameter of ball tips.

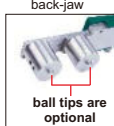

Code	Diameter (D)	Accuracy of diameter	Type	Material
1527-T101	1/16" (Ø1.5875mm)	±0.005mm	A	ruby
1527-T102	1/8" (Ø3.175mm)	±0.005mm	B	stainless steel
1527-T103	3/16" (Ø4.7625mm)	±0.005mm	B	stainless steel
1527-T104	1/4" (Ø6.35mm)	±0.005mm	B	stainless steel
1527-T105	3/8" (Ø9.525mm)	±0.005mm	B	stainless steel
1527-T106	1/2" (Ø12.7mm)	±0.005mm	B	stainless steel

DIGITAL CALIPER WITH INTERCHANGEABLE BALL TIPS

DATA OUTPUT

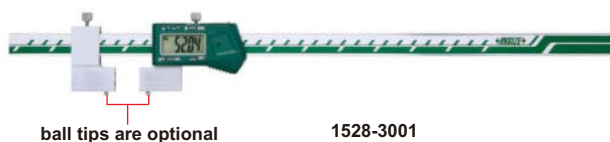

ball tips are optional

1528-3001

- Resolution 0.01mm/0.0005"
- Buttons: on/off, set, mm/inch, preset (+, -)
- Automatic power off, move the digital unit to turn on power
- Battery CR2032, data output
- Made of stainless steel
- Optional accessory: ball tips, data output cable (code 7315-21, 7302-21)

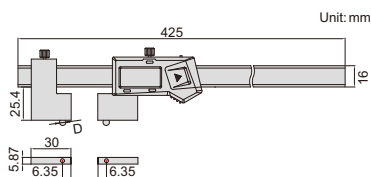

Unit: mm



preset buttons

Code	Range	Accuracy
1528-3001	(12.7+D)~300mm*	±0.03mm

*"D" is the diameter of ball tips.

Ball tips (optional, supplied in pair)

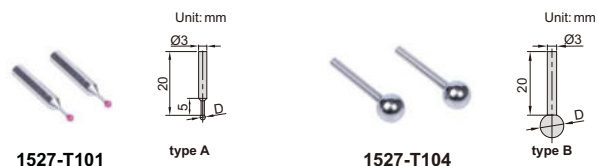

1527-T101

Unit: mm

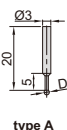

type A



1527-T104

Unit: mm

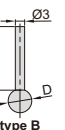

type B

Code	Diameter (D)	Accuracy of diameter	Type	Material
1527-T101	1/16" (Ø1.5875mm)	±0.005mm	A	ruby
1527-T102	1/8" (Ø3.175mm)	±0.005mm	B	stainless steel
1527-T103	3/16" (Ø4.7625mm)	±0.005mm	B	stainless steel
1527-T104	1/4" (Ø6.35mm)	±0.005mm	B	stainless steel
1527-T105	3/8" (Ø9.525mm)	±0.005mm	B	stainless steel
1527-T106	1/2" (Ø12.7mm)	±0.005mm	B	stainless steel

DIGITAL CRIMP HEIGHT CALIPER

DATA OUTPUT

- Measure crimp height
- Resolution: 0.01mm/0.0005"
- Buttons: on/off, zero, mm/inch
- Automatic power off, move the digital unit to turn on power
- Battery CR2032
- Data output
- Meet DIN862
- Made of stainless steel
- Optional accessory: data output cable (code 7315-21, 7302-21)



1165-150A

Code	Range	Accuracy
1165-150A	0-150mm/0-6"	±0.03mm

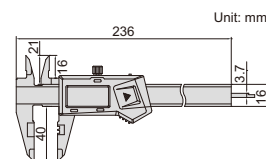
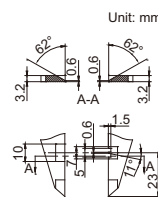

DIGITAL CALIPER WITH LARGE MEASURING FACES

DATA OUTPUT

- Measure diameter of wire ropes, and thickness of soft materials like rubber, sponge, etc.
- Resolution: 0.01mm/0.0005"
- Buttons: on/off, zero, mm/inch
- Automatic power off, move the digital unit to turn on power
- Battery CR2032
- Data output
- Made of stainless steel
- Optional accessory: data output cable (code 7315-21, 7302-21)



1172-200

Code	Range	Accuracy
1172-200	0-200mm/0-8"	±0.07mm

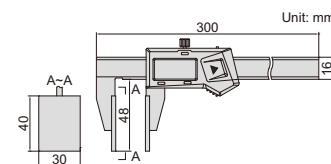

measure diameter of wire ropes

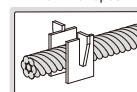

measure thickness of rubber, sponge, etc.



DIGITAL CALIPER WITH DISK FACES

DATA OUTPUT

- Measure thickness of soft sheets
- Resolution: 0.01mm/0.0005"
- Buttons: on/off, zero, mm/inch
- Automatic power off, move the digital unit to turn on power
- Battery CR2032
- Made of stainless steel
- Optional accessory: data output cable (code 7315-21, 7302-21)



1533-150

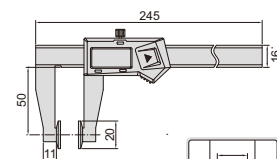

Code	Range	Accuracy
1533-150	0-150mm/0-6"	±0.04mm

DIGITAL WALL THICKNESS CALIPER

DATA OUTPUT

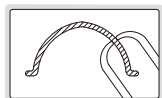

- Measure wall thickness of helmets, domes and curved pots
- Resolution: 0.01mm/0.0005"
- Buttons: on/off, zero, mm/inch, ABS, data preset
- Automatic power off, move the digital unit to turn on power
- Battery CR2032
- Data output
- Made of stainless steel
- Optional accessory: data output cable (code 7315-22, 7302-22)



1536-300

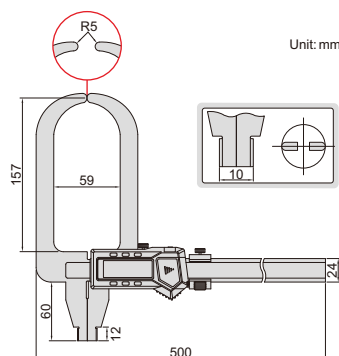

Unit: mm

Code	Range	Accuracy
1536-300	0-300mm/0-12"	±0.05mm

DIGITAL V SHAPE CALIPER

ATTENTION: ACTUAL DIAMETER IS 2/3 OF THE READING



1539-3

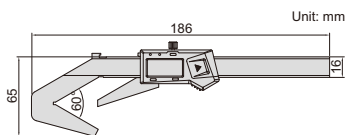

Unit: mm

- Measure outside diameter of three number of flutes (such as taps, reamers, end mills and gears)
- Resolution: 0.01mm/0.0005"
- Buttons: on/off, set, mm/inch, preset (+, -)
- Battery CR2032
- Automatic power off, move the digital unit to turn on power
- Data output
- Made of stainless steel

Code	Range	Accuracy
1539-3	Ø4-Ø40mm/0.16"-1.58" DIA	±0.03mm

V SHAPE VERNIER CALIPER



1273-403

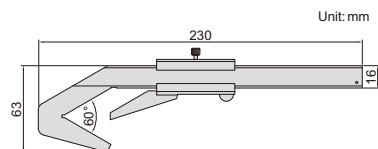

Unit: mm

- Measure outside diameter of three number of flutes (such as taps, reamers, end mills and gears)
- Made of stainless steel
- Satin chrome plated reading surface

Code	Range	Graduation	Accuracy
1273-403	Ø4-40mm	0.05mm	±0.05mm

DIGITAL GEAR TOOTH CALIPERS

ATTENTION: NO DATA OUTPUT

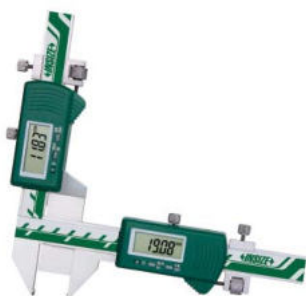
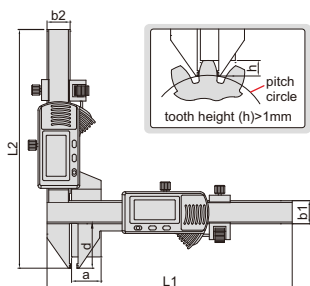

1181-M25A

- Resolution: 0.01mm/0.0005"
- Accuracy of height measurement: ±0.03mm
- Accuracy of thickness measurement: ±0.03mm
- Carbide tips
- Measure the tooth thickness by positioning the tooth height (for tooth height > 1mm)
- Buttons: zero, on/off, mm/inch
- Automatic power off, move the digital unit to turn on power
- Battery CR2032
- Made of stainless steel

(mm)

Code	Range	Total accuracy	L1	L2	a	b1	b2	d
1181-M25A	M1-25mm	±0.04mm	170	165.5	21	16	16	30.5
1181-M50A	M5-50mm	±0.04mm	220	190	50.5	16	16	55

GEAR TOOTH VERNIER CALIPER

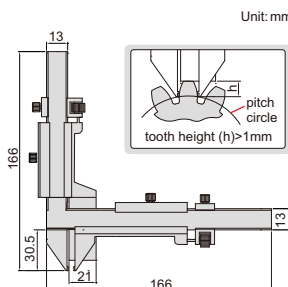

Unit: mm



1281-M26A

- Graduation: 0.02mm
- Total accuracy: ±0.04mm
- Carbide tips
- Measure the tooth thickness by positioning the tooth height (for tooth height > 1mm)
- Made of stainless steel
- Satin chrome plated reading surface

Code	Range	Accuracy of height measurement	Accuracy of thickness measurement
1281-M26A	M1-26mm	±0.03mm	±0.03mm

DIGITAL DISK BRAKE CALIPER

DATA OUTPUT



1162-125A



- Measure thickness of disk brakes
- Resolution 0.01mm/0.0005"
- Buttons: on/off, zero, mm/inch
- Automatic power off, move the digital unit to turn on power
- Battery CR2032, data output
- Made of stainless steel
- Optional accessory: data output cable (code 7315-21, 7302-21)

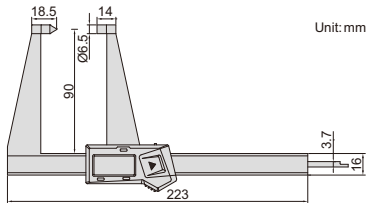

Code	Range	Accuracy
1162-125A	0-125mm/0-5"	±0.05mm

DIGITAL DISK BRAKE AND PAD CALIPER

DATA OUTPUT



1167-150A

- Measure thickness of disk brakes and pad wear
- Resolution: 0.01mm/0.0005"
- Buttons: on/off, zero, mm/inch
- Automatic power off, move the digital unit to turn on power
- Battery CR2032, data output
- Made of stainless steel
- Optional accessory: data output cable (code 7315-21, 7302-21)

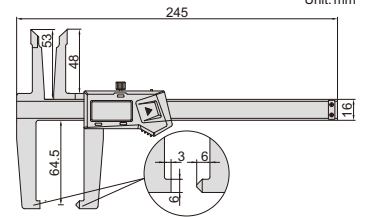

Code	Range	Accuracy
1167-150A	0-150mm/0-6"	±0.07mm



DIGITAL DRUM BRAKE CALIPER

DATA OUTPUT



1168-300A

- Measure internal and external diameter of drum brakes
- Resolution 0.01mm/0.0005"
- Buttons: on/off, zero, mm/inch
- Automatic power off, move the digital unit to turn on power
- Battery CR2032, data output
- Made of stainless steel
- Optional accessory: data output cable (code 7315-21, 7302-21)

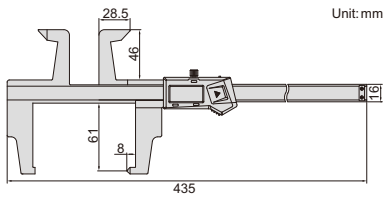

Code	Range	Accuracy
1168-300A	0-300mm/0-12"	±0.07mm



DIGITAL DRUM BRAKE CALIPER

DATA OUTPUT

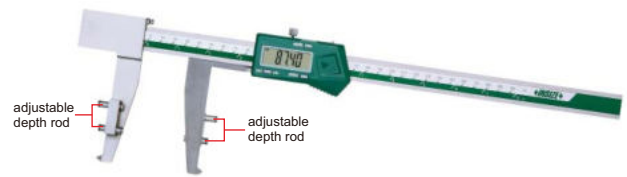

1538-300

- Measure internal diameter of drum brakes
- Resolution: 0.01mm/0.0005"
- Buttons: on/off, zero, mm/inch
- Automatic power off, move the digital unit to turn on power
- Battery CR2032
- Data output
- Made of stainless steel
- Optional accessory: data output cable (code 7315-22, 7302-22)

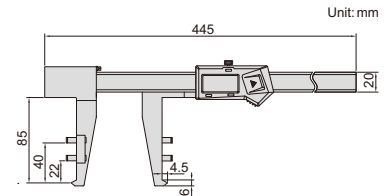

Code	Range	Accuracy
1538-300	30-300mm/1.2-12"	±0.05mm

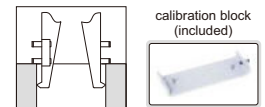

IP67 WATERPROOF DIGITAL DEPTH GAGES

- IP67 dust/waterproof
- Resolution: 0.01mm/0.0005"
- Button function: zero, on/off, mm/inch, ABS/REL, hold
- Meet DIN862
- Battery CR2032
- Made of stainless steel



1149-150

ATTENTION: IT IS NECESSARY TO SET ZERO AFTER POWER ON EACH TIME

ATTENTION: NO DATA OUTPUT

IP67 WATERPROOF

Code	Range	Accuracy	L	a	b	d
1149-150	0-150mm/0-6"	±0.03mm	240	6	16	100
1149-200	0-200mm/0-8"	±0.03mm	290	6	16	100
1149-300	0-300mm/0-12"	±0.03mm	390	6	16	150

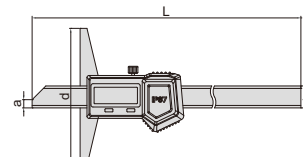

DIGITAL DEPTH GAGES (STANDARD TYPE)

DATA OUTPUT

- Resolution: 0.01mm/0.0005"
- Buttons: on/off, zero, mm/inch
- Automatic power off, move the digital unit to turn on power
- Meet DIN862 (except 1141-500A)
- Battery CR2032, data output
- Made of stainless steel



1141-150A

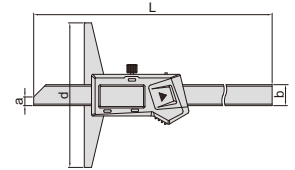

(mm)

Code	Range	Accuracy	L	a	b	d	Data output cable (optional)
1141-150A	0-150mm/0-6"	±0.03mm	230	6	14.5	100	7315-21, 7302-21
1141-200A	0-200mm/0-8"	±0.03mm	280	6	14.5	100	7315-21, 7302-21
1141-300A	0-300mm/0-12"	±0.03mm	380	6	14.5	150	7315-21, 7302-21
1141-500A	0-500mm/0-20"	±0.05mm	585	7	15	150	7315-22, 7302-22

DIGITAL DEPTH GAGES WITH MOUNTING HOLES FOR EXTENSION BASE

DATA OUTPUT



1147-300

- Resolution: 0.01mm/0.0005"
- Buttons: on/off, zero, mm/inch
- Automatic power off, move the digital unit to turn on power
- Meet DIN862
- Battery CR2032, data output
- Made of stainless steel
- Optional accessory: data output cable (code 7315-21, 7302-21), extension base (code 6141)

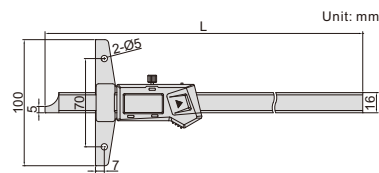

Code	Range	Accuracy	L
1147-150	0-150mm/0-6"	±0.03mm	237mm
1147-200	0-200mm/0-8"	±0.03mm	287mm
1147-300	0-300mm/0-12"	±0.03mm	403mm

extension base (optional)



DIGITAL HOOK DEPTH GAGES

DATA OUTPUT



1142-150A

- Resolution: 0.01mm/0.0005"
- Buttons: on/off, zero, mm/inch
- Automatic power off, move the digital unit to turn on power
- Battery CR2032
- Data output
- Made of stainless steel
- Optional accessory: data output cable (code 7315-21, 7302-21)

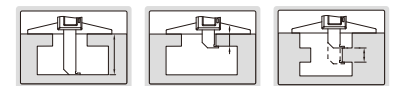
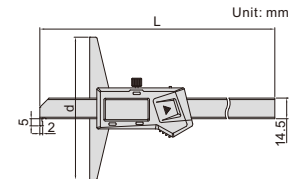

Code	Range	Accuracy	L	d
1142-150A	0-150mm/0-6"	±0.03mm	230mm	100mm
1142-200A	0-200mm/0-8"	±0.03mm	280mm	100mm

DIGITAL DOUBLE HOOK DEPTH GAGES

DATA OUTPUT



1144-150A

- Resolution: 0.01mm/0.0005"
- Buttons: on/off, zero, mm/inch
- Automatic power off, move the digital unit to turn on power
- Meet DIN862
- Battery CR2032
- Data output
- Made of stainless steel
- Optional accessory: data output cable (code 7315-21, 7302-21)

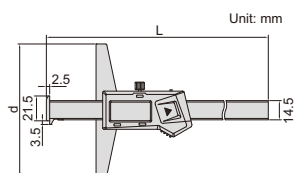

(mm)

Code	Range	Accuracy	L	d
1144-150A	0-150mm/0-6"	±0.03mm	233	100
1144-200A	0-200mm/0-8"	±0.03mm	283	100
1144-300A	0-300mm/0-12"	±0.03mm	383	150

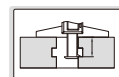
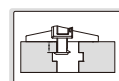

DIGITAL POINT DEPTH GAGE

DATA OUTPUT



1143-200A

- Resolution: 0.01mm/0.0005"
- Buttons: on/off, zero, mm/inch
- Automatic power off, move the digital unit to turn on power
- Meet DIN862
- Battery CR2032, data output
- Made of stainless steel
- Optional accessory: data output cable (code 7315-21, 7302-21)

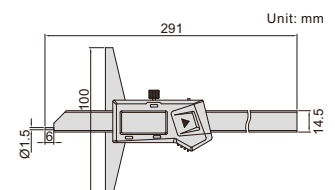

Code	Range	Accuracy
1143-200A	0-200mm/0-8"	±0.03mm

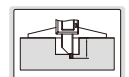

DIGITAL DEPTH GAGES WITH ROUND DEPTH BAR

MEASURE WIDTH AND DEPTH OF GROOVES INSIDE BORE

MEASURE DEPTH OF SMALL HOLES (>Ø4mm)

DATA OUTPUT

preset buttons

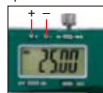

extension base for 1148-200 (optional)



6141 series

- Resolution: 0.01mm/0.0005"
- Supplied with three interchangeable points (flat, spherical, disk)
- Buttons: on/off, set, mm/inch, preset (+, -)
- Automatic power off, move the digital unit to turn on power
- Battery CR2032, data output
- Made of stainless steel
- Optional accessory: data output cable (code 7315-21, 7302-21), extension base (code 6141, for 1148-200)



1148-100S

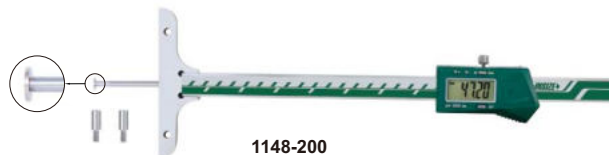

1148-200

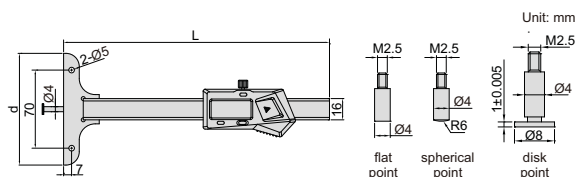

(mm)

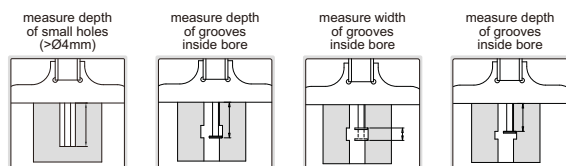

1148-P103 (optional), measure width of bottom grooves inside blind hole

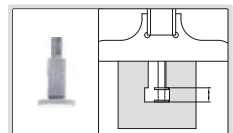

1148-P101 (optional)

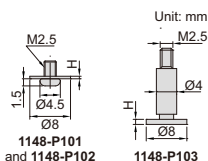

Code	Range*	Accuracy	L	d	Remark
1148-100S	0-100mm/0-4"	±0.02mm	200	45	
1148-100	0-100mm/0-4"	±0.02mm	200	85	
1148-200	0-200mm/0-8"	±0.03mm	300	101	with mounting holes for extension base

*When disk points are used, the range is reduced by 10mm

OPTIONAL DISK POINTS

Code	Description	H	Remark
1148-P101	0.5mm disk point	0.5±0.005mm	for narrow grooves
1148-P102	0.7mm disk point	0.7±0.005mm	for narrow grooves
1148-P103	1mm disk point	1±0.005mm	for grooves inside blind hole

DIGITAL DOUBLE HOOK DEPTH GAGE

- Resolution: 0.01mm/0.0005"
- Buttons: on/off, zero, mm/inch, ABS/INC, data hold, TOL, set
- ABS/INC is for absolute and incremental measurement
- TOL is for tolerance measurement
- Made of stainless steel
- LR44 battery, data output
- Supplied with gage block for zero setting
- Optional accessory: extension base, wireless transmitter (code 7315-1150), data output cable (code 7302-SPC7, keyboard format)

gage block for zero setting (included)



Extension base (optional)

Code	L
1540-L300	300mm
1540-L400	400mm
1540-L500	500mm
1540-L600	600mm
1540-L800	800mm

Code	Range	Accuracy
1540-300	0-300mm/0-12"	±0.04mm



1540-300

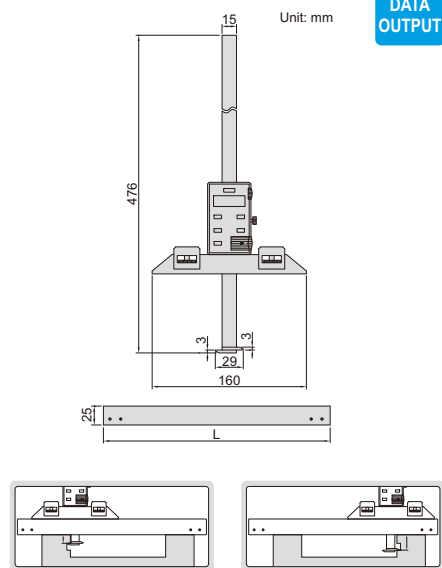

DIAL DEPTH GAGE

SHOCK PROOF

- Shockproof dial indicator
- Made of stainless steel



1340-150

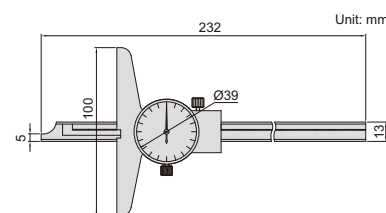

Code	Range	Graduation	Accuracy
1340-150	0-150mm	0.02mm	±0.03mm

VERNIER DEPTH GAGES (STANDARD TYPE)

- Made of stainless steel
- Satin chrome plated reading surface



1240-2001

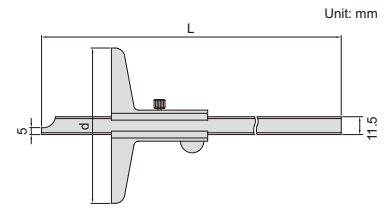

Graduation 0.05mm				(mm)	
Code	Range	Accuracy	L	d	
1240-150	0-150mm	±0.05mm	245	100	
1240-200	0-200mm	±0.05mm	282	100	
1240-300	0-300mm	±0.08mm	382	100	
1240-500	0-500mm	±0.09mm	585	150	

Graduation 0.02mm				(mm)	
Code	Range	Accuracy	L	d	
1240-1501	0-150mm	±0.03mm	245	100	
1240-2001	0-200mm	±0.03mm	282	100	
1240-3001	0-300mm	±0.04mm	382	100	
1240-5001	0-500mm	±0.05mm	585	150	

EXTENSION BASES



6141-260

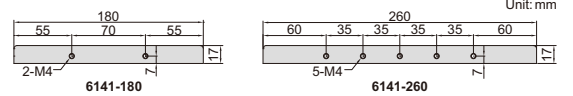

- Supplied with two screws
- Made of stainless steel
- Suitable for depth gages series 1147, 1148, 1247, 1248 and 1249

Code	Length
6141-180	180mm
6141-260	260mm
6141-320	320mm

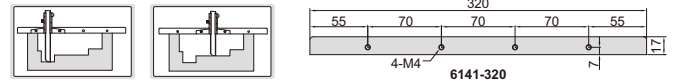

MINI DIGITAL DEPTH GAGE

DATA OUTPUT

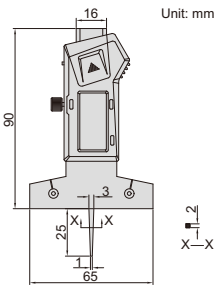
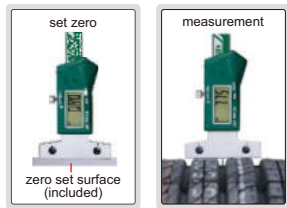

1145-25A

- Measure depth of small groove and hole, also measure depth of tire tread
- Buttons: on/off, zero, mm/inch
- Supplied with zero set surface
- Automatic power off, move the digital unit to turn on power
- Battery CR2032
- Data output
- Made of stainless steel
- Optional accessory: data output cable (code 7315-21, 7302-21)

Code	Range	Accuracy	Resolution
1145-25A	0-25mm/0-1"	±0.03mm	0.01mm/0.0005"

MINI DIGITAL DEPTH GAGES WITH ROUND BAR

DATA OUTPUT

- Measure depth of small groove and hole
- Resolution: 0.01mm/0.0005"
- Buttons: on/off, set, mm/inch, preset (+,-)
- Automatic power off, move the digital unit to turn on power
- Battery CR2032
- Data output
- Made of stainless steel
- Optional accessory: data output cable (code 7315-21, 7302-21)

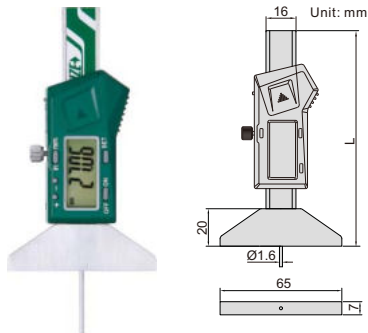

1140-25

Code	Range	Accuracy	L
1140-25	0-25mm/0-1"	±0.02mm	114mm
1140-50	0-50mm/0-2"	±0.02mm	140mm

VERNIER DEPTH GAGE (ECONOMIC TYPE)



1244-30

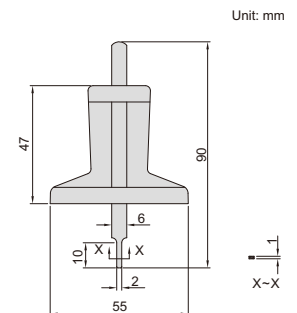

- Graduation: 0.1mm
- Made of stainless steel

Code	Range	Accuracy
1244-30	0-30mm	±0.10mm

DIGITAL DEPTH GAGES

DATA
OUTPUT

- Accuracy: $\pm 20\mu\text{m}$
- Button function: on/off, zero, mm/inch, ABS, data preset, change measuring direction
- CR2032 battery
- Automatic power off (time is adjustable)
- Data output
- Stainless steel base
- Extension rods: 12.5mm (1 pc), 25mm (1 pc), 50mm (1 pc), 75mm (1 pc), 100mm (2 pcs)
- Supplied with pointed tip and ball tip
- Optional accessory: data output cable (code **7315-50M**, **7302-40M**), granite extension holder (code **2141-10**)



2141-202A

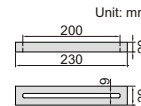
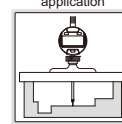
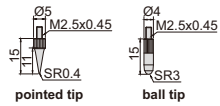
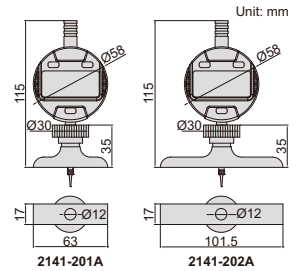

2141-10 (optional),
can be customized
according to workpieces

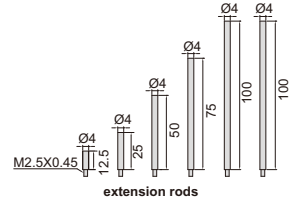

Code	Range	Digital indicator stroke	Digital indicator resolution	Base
2141-201A	0-300mm/0-12"	12.7mm/0.5"	0.01mm/0.0005"	63x17mm
2141-202A	0-300mm/0-12"	12.7mm/0.5"	0.01mm/0.0005"	101.5x17mm

DIAL DEPTH GAGE

- Accuracy: $\pm 0.03\text{mm}$
- Dial indicator stroke: 30mm
- Dial indicator graduation: 0.01mm
- Stainless steel base
- Extension rods: 25mm (1 pc), 50mm (1 pc), 75mm (1 pc), 100mm (2 pcs)
- Supplied with pointed tip and ball tip
- Optional accessory: granite extension holder (code **2141-10**)



2342-202

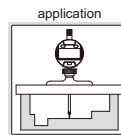
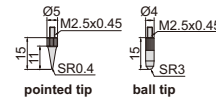
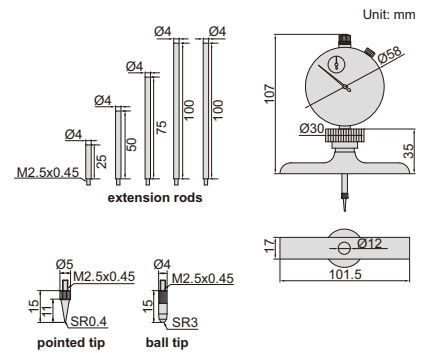

2141-10 (optional),
can be customized
according to workpieces

Code	Range	Base
2342-202	0-300mm	101.5x17mm

DIAL DEPTH GAGES

- Accuracy: $\pm 0.017\text{mm}$
- Stainless steel base
- Pointed tip

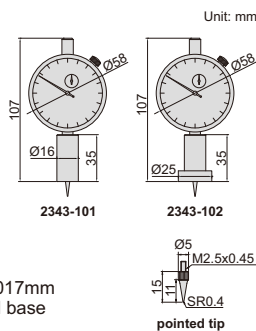

2343-102

Code	Range	Dial indicator stroke	Dial indicator graduation	Base
2343-101	0-10mm	10mm	0.01mm	$\varnothing 16\text{mm}$
2343-102	0-10mm	10mm	0.01mm	$\varnothing 25\text{mm}$

DIAL DEPTH GAGE

- Dial indicator graduation: 0.01mm
- Stainless steel base
- Supplied with pointed tip and ball tip

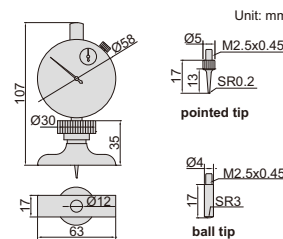

2341-101A

Code	Range	Dial indicator stroke	Accuracy
2341-101A	0-10mm	10mm	$\pm 0.017\text{mm}$

DEPTH MICROMETERS

- Graduation: 0.01mm
- Meet DIN863-2
- Micrometer head accuracy: $\pm 3\mu\text{m}$
- Rod accuracy: $\pm(2+L/75)\mu\text{m}$, L is the measuring range in mm
- Rods with flat end
- Ratchet stop



3241-100

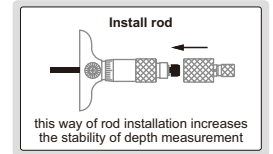
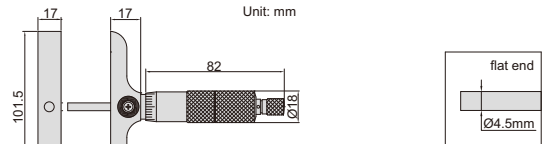

Code	Range	Rods
3241-25	0-25mm	1 pc
3241-50	0-50mm	2 pcs
3241-100	0-100mm	4 pcs
3241-150	0-150mm	6 pcs
3241-300	0-300mm	12 pcs

DIGITAL DEPTH MICROMETERS

DATA OUTPUT IP65 WATERPROOF

- Micrometer head accuracy: $\pm 3\mu\text{m}$
- Rod accuracy: $\pm(2+L/75)\mu\text{m}$, L is the measuring range in mm
- Button function: on/off, set, mm/inch, data transmit
- IP65 dust/waterproof
- Data output
- Automatic power off
- Rods with flat end
- Ratchet stop
- Optional accessory: data output cable (code 7315-30, 7302-30)



3540-50

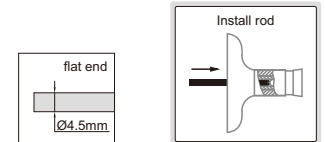
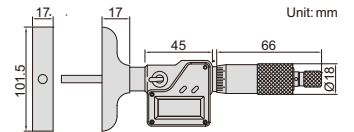

Code	Range	Resolution	Rods
3540-50	0-50mm/0-2"	0.001mm/0.00005"	2 pcs
3540-150	0-150mm/0-6"	0.001mm/0.00005"	6 pcs
3540-300	0-300mm/0-12"	0.001mm/0.00005"	12 pcs

HIGH PRECISION DIGITAL HEIGHT GAGES

DATA OUTPUT



power supplied by charge pal

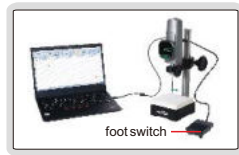

data transmitted to Excel without software; short press the foot switch to transmit data, long press to zero

- Measuring force: 0.8~1.2N
- Power supply: 5V/1A (adapter or charge pal)
- High stability, high precision, high response speed (5000mm/s)
- High brightness LED display
- Ceramic base flatness: $1\mu\text{m}$

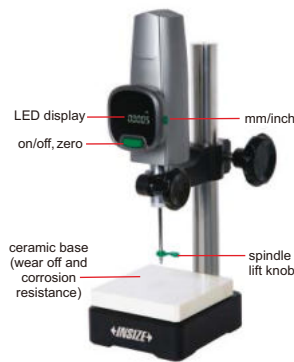
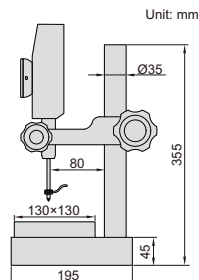

1155-505

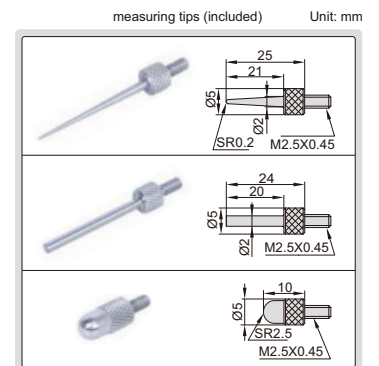

Code	Range	Resolution	Accuracy (20°C)	Output
1155-505	0~50mm	0.5 μm /0.00002" (can switch to: 1 μm /0.00005")	1.5 μm	USB
1155-510	0~50mm	0.1 μm /0.000005" (can switch to: 1 μm /0.00005")	1 μm	USB

STANDARD DELIVERY

Main unit	1 pc
-----------	------

OPTIONAL ACCESSORY

Contact point	code 6282
Charge pal	1155-5-POB
Data output cable (including foot switch)	1155-5-FOS

DIGITAL HEIGHT GAGES



DATA OUTPUT

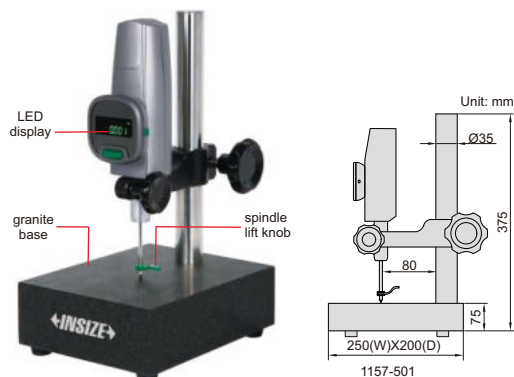

1157-501

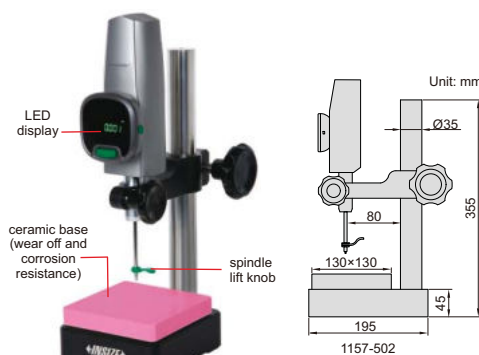

1157-502

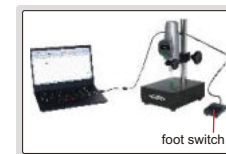

data transmitted to Excel without software

- Measuring force: 0.8~1.2N
- Power supply: 5V/1A (adapter or charge pal)
- Buttons: on/off, zero, mm/inch, mix/min/mix-min
- High response speed (5000mm/s)
- High brightness LED display

Code	Range	Resolution	Accuracy (20°C)	Output	Base
1157-501	0~50mm	1µm/0.00005"	3µm	USB	granite (flatness: 2µm)
1157-502	0~50mm	1µm/0.00005"	3µm	USB	ceramic (flatness: 1µm)

STANDARD DELIVERY

Main unit	1 pc
-----------	------

measuring tips (included) Unit: mm

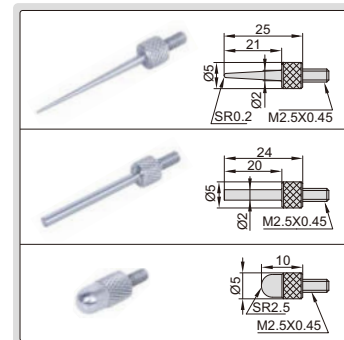

power supplied by charge pal

OPTIONAL ACCESSORY

Contact point	code 6282
Charge pal	1155-5-POB
Data output cable (including foot switch)	1155-5-FOS

DIGITAL HEIGHT GAGES WITH DRIVING WHEEL



DATA OUTPUT

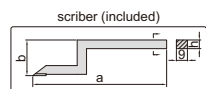
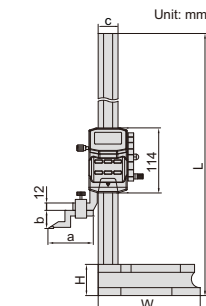
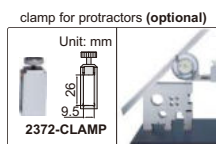
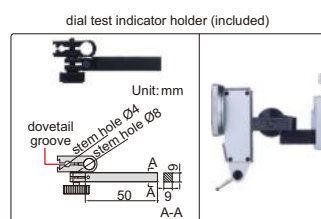

- Resolution: 0.01mm/0.0005"
- Buttons: on/off, zero, mm/inch, preset +, preset -, hold
- Automatic power off, move the digital unit to turn on power
- Carbide tipped scriber
- Made of stainless steel
- Battery CR2032
- Data output
- Supplied with dust cover
- With dial test indicator holder
- Optional accessory: data output cable (code 7315-22, 7302-22), clamp for protractors (code 2372-CLAMP)

Code	Range	Accuracy	L	W	H	a	b	c	h
1156-300*	0-300mm/0-12"	±0.03mm	515	180	55	80	30	35	9
1156-600*	0-600mm/0-24"	±0.05mm	815	180	55	80	30	35	9
1156-1000*	0-1000mm/0-40"	±0.07mm	1220	265	70	92	48	40	12

*Supplied with manufacturer inspection certificate



1156-300

1156-1000

DIGITAL HEIGHT GAGES

DATA
OUTPUT

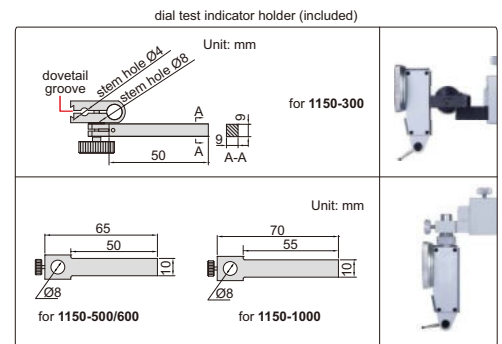
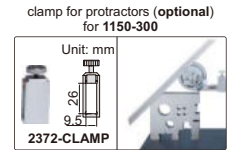
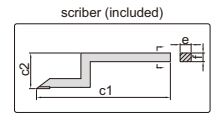
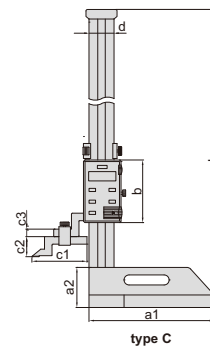
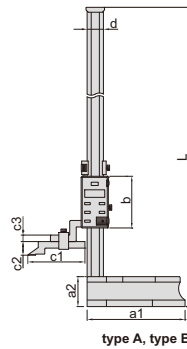

- Resolution: 0.01mm/0.0005"
- Buttons: on/off, zero, mm/inch, ABS/INC, data hold, TOL, set
- ABS/INC is for absolute and incremental measurement
- TOL is for tolerance measurement
- Carbide tipped scriber
- Made of stainless steel (except the base)
- LR44 battery, data output
- Supplied with dial test indicator holder
- Supplied with dust cover
- Optional accessory: wireless transmitter (code 7315-1150), data output cable (code 7302-SPC7, keyboard format), clamp for protractors (code 2372-CLAMP, for 1150-300)

Code	Range	Type	Accuracy	L	a1	a2	b	c1	c2	c3	d	e	f
1150-300	0-300mm/0-12"	A	$\pm 0.04\text{mm}$	485mm	138mm	45mm	95mm	80mm	30mm	10mm	28mm	9mm	9mm
1150-500	0-500mm/0-20"	B	$\pm 0.06\text{mm}$	720mm	180mm	55mm	95mm	103mm	25mm	12mm	30mm	10mm	12mm
1150-600	0-600mm/0-24"	B	$\pm 0.06\text{mm}$	820mm	180mm	55mm	95mm	103mm	25mm	12mm	30mm	10mm	12mm
1150-1000	0-1000mm/0-40"	C	$\pm 0.08\text{mm}$	1275mm	250mm	80mm	125mm	110mm	39mm	15mm	50mm	10mm	15mm

DIGITAL HEIGHT GAGES

DATA
OUTPUT

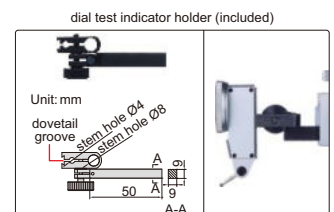
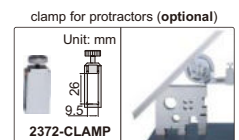
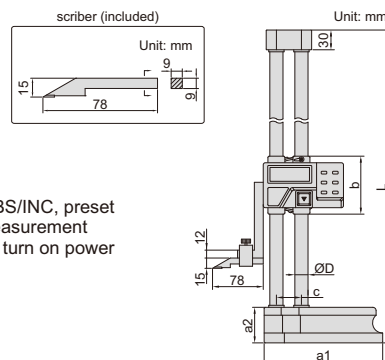

- Resolution: 0.01mm/0.0005"
- Buttons: on/off, zero, mm/inch, data hold, ABS/INC, preset
- ABS/INC is for absolute and incremental measurement
- Automatic power off, move the digital unit to turn on power
- Carbide tipped scriber
- Made of stainless steel
- Battery CR2032, data output
- With driving wheel
- With dial test indicator holder
- Supplied with dust cover
- Optional accessory: clamp for protractors (code 2372-CLAMP), wireless transmitter (code 7315-1151), data output cable (code 7302-1151, keyboard format)

Code	Range	Accuracy	L	a1	a2	b	c	$\varnothing D$
1151-300A	0-300mm/0-12"	$\pm 0.04\text{mm}$	475	135	43	84	33	15
1151-450A	0-450mm/0-18"	$\pm 0.05\text{mm}$	660	180	54	88	38	20
1151-600A	0-600mm/0-24"	$\pm 0.05\text{mm}$	810	180	54	88	38	20

DIAL HEIGHT GAGES

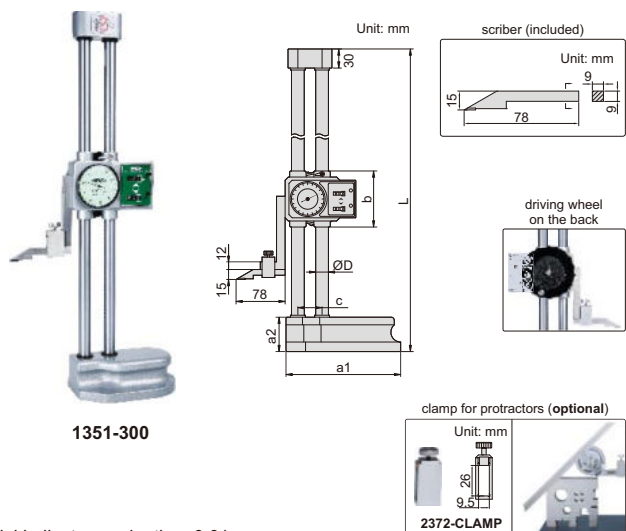

1351-300

- Dial indicator graduation: 0.01mm
- One counter reads in the plus direction and another in the minus direction, so incremental measurement can be made in either direction
- Carbide tipped scribe
- Made of stainless steel (except the base)
- With driving wheel
- With dial test indicator holder
- Supplied with dust cover
- Optional accessory: clamp for protractors (code 2372-CLAMP)

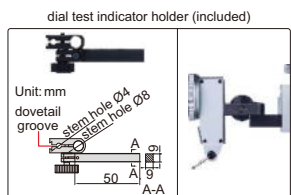

(mm)

Code	Range	Accuracy	L	a1	a2	b	c	ØD
1351-300	0-300mm	±0.04mm	475	135	43	84	33	15
1351-450	0-450mm	±0.05mm	660	180	54	88	38	20
1351-600	0-600mm	±0.05mm	810	180	54	88	38	20

VERNIER HEIGHT GAGES (BASIC TYPE)

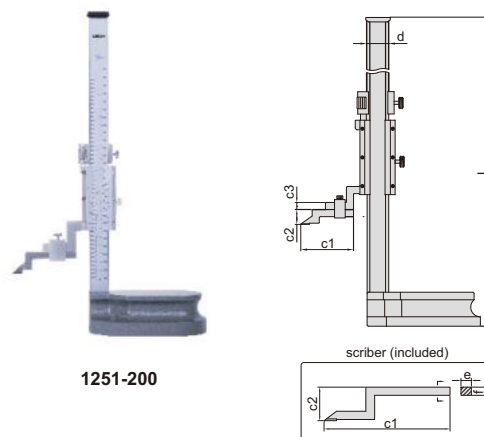

1251-200

- Graduation: 0.02mm/0.001"
- Carbide tipped scribe
- Made of stainless steel (except the base)
- Satin chrome plated scale
- With dial test indicator holder
- Supplied with dust cover

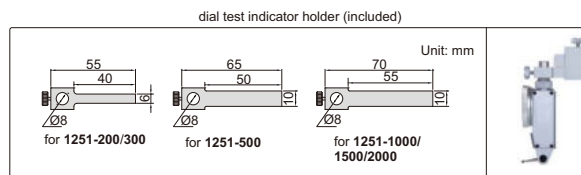

(mm)

Code	Range	Accuracy	L	c1	c2	c3	d	e	f
1251-200	0-200mm/0-8"	±0.03mm	370	76	25	10	23	6	8
1251-300	0-300mm/0-12"	±0.04mm	470	76	25	10	23	6	8
1251-500	0-500mm/0-20"	±0.05mm	720	105	25	12	30	10	12
1251-1000	0-1000mm/0-40"	±0.07mm	1275	110	39	15	50	10	15
1251-1500	0-1500mm/0-60"	±0.11mm	1790	110	39	15	50	10	15
1251-2000	0-2000mm/0-80"	±0.14mm	2290	110	39	15	50	10	15

VERNIER HEIGHT GAGES



1250-300

- Graduation: 0.02mm/0.001"
- Adjustable main scale to set zero
- Carbide tipped scribe
- Made of stainless steel (except the base)
- Satin chrome plated scale
- Supplied with magnifier
- With fine adjustment
- Supplied with dust cover
- Optional accessory: dial test indicator holder (code 6293-6), clamp for protractors (code 2372-CLAMP)

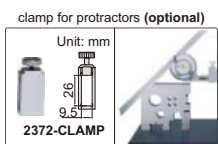

(mm)

Code	Range	Accuracy	L	a1	a2	b	c1	c2	d
1250-300	0-300mm/0-12"	±0.04mm	545	135	43	75	80	30	28
1250-600	0-600mm/0-24"	±0.05mm	870	180	54	85	80	41	35

VERNIER HEIGHT GAGES

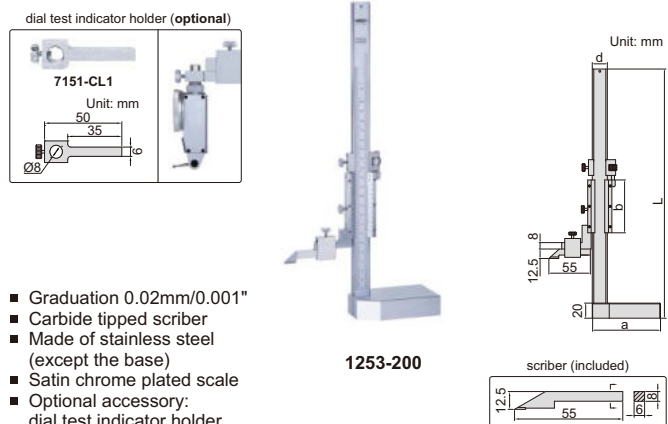

1253-200

- Graduation 0.02mm/0.001"
- Carbide tipped scribe
- Made of stainless steel (except the base)
- Satin chrome plated scale
- Optional accessory: dial test indicator holder (code 7151-CL1)

Code	Range	Accuracy	L	a	b	d
1253-150	0-150mm/0-6"	±0.03mm	265mm	75mm	57mm	16mm
1253-200	0-200mm/0-8"	±0.03mm	325mm	90mm	70mm	20mm

DIGITAL HEIGHT GAGE

DATA OUTPUT

dial test indicator holder (optional)

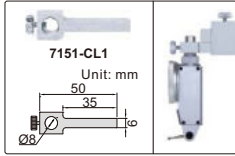

1154-150

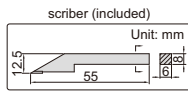
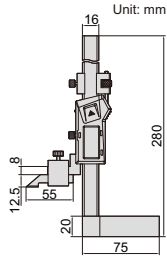

- Buttons: on/off, zero, mm/inch
- Automatic power off, move the digital unit to turn on power
- Carbide tipped scriber
- With fine adjustment
- Made of stainless steel
- Battery CR2032, data output
- Optional accessory: data output cable (code 7315-22, 7302-22), dial test indicator holder (code 7151-CL1)

Code	Range	Resolution	Accuracy
1154-150	0-150mm/0-6"	0.01mm/0.0005"	±0.03mm

MINI DIGITAL HEIGHT GAGE

DATA OUTPUT



1146-20A

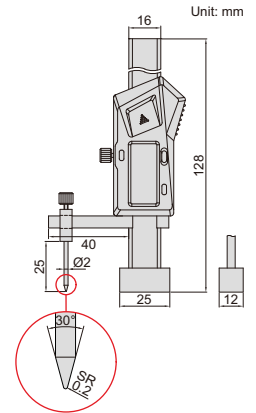

- Measure height difference of two surfaces
- Resolution: 0.01mm/0.0005"
- Buttons: on/off, zero, mm/inch
- Automatic power off, move the digital unit to turn on power
- Battery CR2032, data output
- Made of stainless steel
- Optional accessory: data output cable (code 7315-21, 7302-21)

Code	Range	Accuracy
1146-20A	0~±20mm/0~±0.8"	±0.02mm

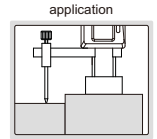

HIGH PRECISION DIGITAL MICROMETERS/SNAP GAGES

ATTENTION: RECHARGEABLE BATTERY, FOR 24 HOURS CONTINUOUS WORKING

ABSOLUTE ENCODER, THE ORIGINAL DATA REMAINS AFTER POWER OFF

IP65 WATERPROOF

MEASUREMENT ACCURACY IS NOT AFFECTED BY THE USE OF SLEEVE

ONE TURN OF SLEEVE MAKES 5MM SPINDLE FEED, PRESS THE FORK, THE SPINDLE RETRACTS 3MM

NON-ROTATING SPINDLE

DATA OUTPUT

- Absolute encoder, the original data remains after power off
- Adjustable resolution: 0.0002mm/0.00001", 0.001mm/0.00005", 0.01mm/0.0005"
- One turn of sleeve makes 5mm spindle feed
- Measurement accuracy is not affected by the use of sleeve
- Press the fork, the spindle retracts 3mm
- Linear ball bearings for ten million times use
- Carbide spindle and anvil
- Measuring force 7-10N
- Customizable measuring force range 2-12N
- Attention: small measuring force will reduce the dustproof and waterproof level
- Button function: data output, tolerance, data preset, data hold, measuring direction change, max./min./TIR, power off time, on/off, zero, mm/inch, adjust resolution
- Supplied with gage blocks for zero setting (except 0-25mm/0-1")
- Power: rechargeable battery, for 24 hours continuous working

With data interface

Optional accessory:
wireless transmitter, code 7315-3350,
data output cable (keyboard format), code 7302-3350



3350-25

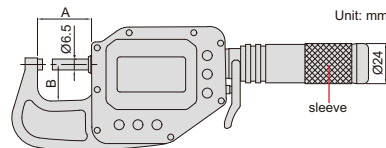

Code	Range	Accuracy	Repeatability	Measuring faces		A	B
				Flatness	Parallelism		
3350-25*	0-25mm/0-1"	1.4µm	0.6µm	0.5µm	1µm	38mm	24mm
3350-50*	25-50mm/1-2"	1.6µm	1µm	0.5µm	1µm	63mm	28mm
3350-75*	50-75mm/2-3"	1.8µm	1µm	0.5µm	1µm	88mm	45mm
3350-100*	75-100mm/3-3.95"	2µm	1µm	0.5µm	1µm	113mm	57mm

*Supplied with manufacturer inspection certificate

INSPECTION CERTIFICATE



warning when over tolerance

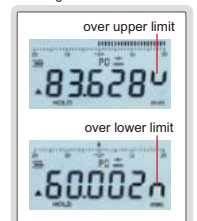

WATERPROOF DIGITAL OUTSIDE MICROMETERS (WITH DATA OUTPUT)

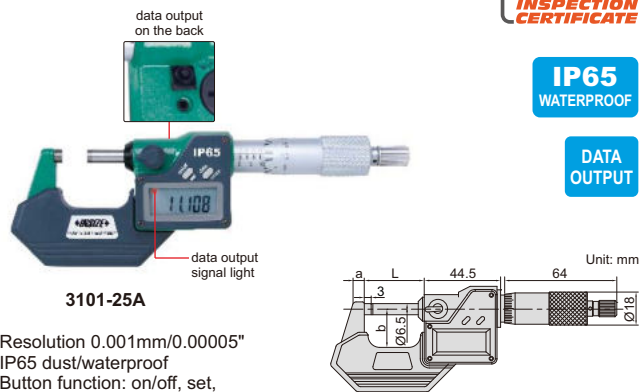

3101-25A

- Resolution 0.001mm/0.00005"
- IP65 dust/waterproof
- Button function: on/off, set, mm/inch, data transmit
- Data output
- Automatic power off
- Carbide measuring faces
- Ratchet stop
- Supplied with spherical anvil
- Setting standards are included (except 0-25mm/0-1")
- Optional accessory: data output cable (code 7315-30, 7302-30)

INSPECTION CERTIFICATE

IP65 WATERPROOF

DATA OUTPUT

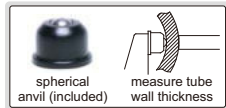
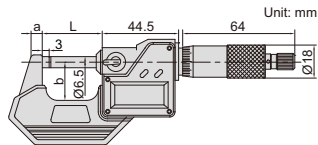

(mm)

Code	Range	Accuracy	L	a	b
3101-25A*	0-25mm/0-1"	±2µm	34.5	6	25
3101-50A*	25-50mm/1-2"	±2µm	59.5	8	32
3101-75A*	50-75mm/2-3"	±3µm	84.5	8	44.5
3101-100A*	75-100mm/3-4"	±3µm	109.5	8	57
3101-125A	100-125mm/4-5"	±3µm	135	10	70
3101-150A	125-150mm/5-6"	±3µm	160.5	10	82

*Supplied with manufacturer inspection certificate

WATERPROOF DIGITAL OUTSIDE MICROMETERS (WITHOUT DATA OUTPUT)

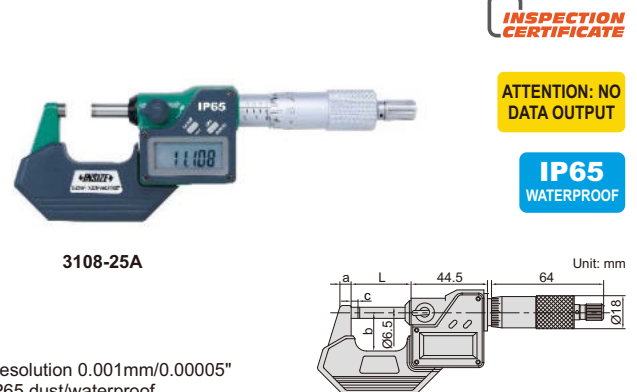

3108-25A

- Resolution 0.001mm/0.00005"
- IP65 dust/waterproof
- Button function: on/off, set, mm/inch, ABS/INC
- No data output
- Automatic power off
- Carbide measuring faces
- Ratchet stop
- Supplied with spherical anvil
- Setting standards are included (except 0-25mm/0-1")

INSPECTION CERTIFICATE

ATTENTION: NO DATA OUTPUT

IP65 WATERPROOF

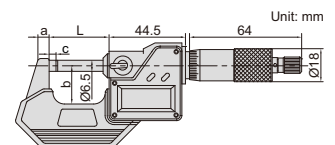

(mm)

Code	Range	Accuracy	L	a	b	c
3108-25A*	0-25mm/0-1"	±2µm	34.5	6	25	3
3108-50A*	25-50mm/1-2"	±2µm	59.5	8	32	3
3108-75A*	50-75mm/2-3"	±3µm	84.5	8	44.5	3
3108-100A*	75-100mm/3-4"	±3µm	109.5	8	57	3
3108-125A	100-125mm/4-5"	±3µm	135	10	70	3
3108-150A	125-150mm/5-6"	±3µm	160.5	10	82	3

*Supplied with manufacturer inspection certificate

DIGITAL OUTSIDE MICROMETERS (BASIC TYPE, WITHOUT DATA OUTPUT)

INSPECTION CERTIFICATE

ATTENTION: NO DATA OUTPUT

- Resolution 0.001mm/0.00005"
- Button function: on/off, set, mm/inch, ABS/INC
- No data output
- Automatic power off
- Carbide measuring faces
- Friction thimble
- Supplied with spherical anvil
- Setting standards are included (except 0-25mm/0-1")



3109-25A

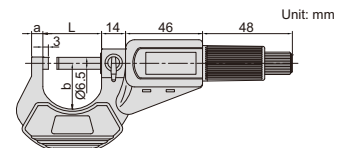
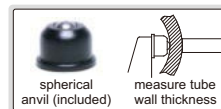

(mm)

Code	Range	Accuracy	L	a	b
3109-25A*	0-25mm/0-1"	±2µm	32	6	27.5
3109-50A*	25-50mm/1-2"	±2µm	57	8	37
3109-75A*	50-75mm/2-3"	±3µm	82	8	50
3109-100A*	75-100mm/3-4"	±3µm	107	10	61
3109-125A	100-125mm/4-5"	±3µm	132	10	73
3109-150A	125-150mm/5-6"	±3µm	157	10	85

*Supplied with manufacturer inspection certificate

DIGITAL VERTICAL MICROMETER

- Measure the thickness of plates for easy reading
- Resolution 0.001mm/0.00005"
- IP65 dust/waterproof
- Button function: on/off, set, mm/inch, ABS/INC
- Data output
- Automatic power off
- Carbide spindle tip
- Ratchet stop
- Optional accessory: data output cable (code 7315-30, 7302-30)



3565-25A

INSPECTION CERTIFICATE

DATA OUTPUT

IP65 WATERPROOF

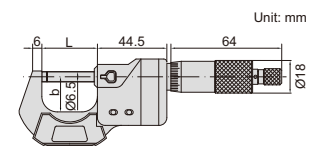

Unit: mm

Code	Range	Accuracy	L	b
3565-25A*	0-25mm/0-1"	±2µm	34.5mm	25mm

*Supplied with manufacturer inspection certificate

OUTSIDE MICROMETERS

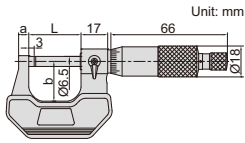

3202-25A

- Graduation 0.01mm
- Carbide measuring faces
- Meet DIN863-1
- Supplied with setting standards (except 0-25mm)

Individual			(mm)		
Code	Range	Accuracy	L	a	b
3202-25A*	0-25mm	4µm	32	6	24
3202-50A*	25-50mm	4µm	57	8	32
3202-75A*	50-75mm	5µm	82	8	45
3202-100A*	75-100mm	5µm	107	8	57

Set

Code	Range	Micrometers included
3202-1004A*	0-100mm	3202-25A, 3202-50A, 3202-75A, 3202-100A
3202-1506A	0-150mm	3202-25A, 3202-50A, 3202-75A, 3202-100A, 3202-125A, 3202-150A

*Supplied with manufacturer inspection certificate

OUTSIDE MICROMETERS



3203-50A



3203-25A



3203-1004A



3203-3006A

Individual (mm)

Code	Range	Accuracy	L	a	b
3203-25A*	0-25mm	±2µm	32	9	28
3203-50A*	25-50mm	±2µm	57	14	38
3203-75A*	50-75mm	±2µm	82	15	49
3203-100A*	75-100mm	±3µm	107	15	60
3203-125A	100-125mm	±3µm	133	16.5	73
3203-150A	125-150mm	±3µm	158	16.5	85
3203-175A	150-175mm	±4µm	183	19.4	104
3203-200A	175-200mm	±4µm	209	19.4	117
3203-225A	200-225mm	±4µm	234	19.4	130
3203-250A	225-250mm	±5µm	260	19.4	142
3203-275A	250-275mm	±5µm	285	19.4	155
3203-300A	275-300mm	±5µm	310	19.4	168

- Graduation: metric 0.01mm
- Carbide measuring faces
- Meet DIN863-1
- Ratchet stop
- Supplied with setting standards (except 0-25mm and 0-1")

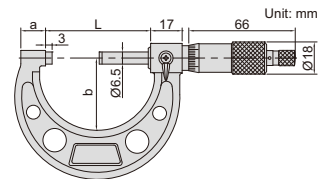

Set

Code	Range	Micrometers included	Packaging
3203-1004A*	0-100mm	3203-25A, 3203-50A, 3203-75A, 3203-100A	blow mould case
3203-1506A	0-150mm	3203-25A, 3203-50A, 3203-75A, 3203-100A, 3203-125A, 3203-150A	blow mould case
3203-3006A	150-300mm	3203-175A, 3203-200A, 3203-225A, 3203-250A, 3203-275A, 3203-300A	aluminum box

*Supplied with manufacturer inspection certificate

1µm GRADUATION OUTSIDE MICROMETERS



- Graduation: 0.001mm
- Carbide measuring faces
- Meet DIN863-1
- Ratchet stop
- Supplied with setting standards (except 0-25mm)



3210-25A

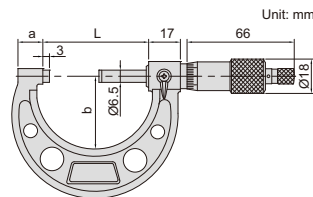

Individual (mm)

Code	Range	Accuracy	L	a	b
3210-25A*	0-25mm	4µm	32	9	28
3210-50A*	25-50mm	4µm	57	14	38
3210-75A*	50-75mm	5µm	82	15	49
3210-100A*	75-100mm	5µm	107	15	60

Set

Code	Range	Micrometers included
3210-1004A*	0-100mm	3210-25A, 3210-50A, 3210-75A, 3210-100A
3210-1506A	0-150mm	3210-25A, 3210-50A, 3210-75A, 3210-100A, 3210-125A, 3210-150A

*Supplied with manufacturer inspection certificate

OUTSIDE MICROMETER FOR LEFT OR RIGHT HANDERS

- Graduation 0.01mm
- Graduations on two sides
- Ratchet stop
- Carbide measuring faces
- Meet DIN863-1



3236-25B

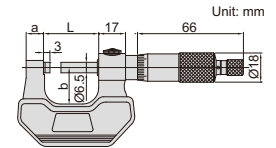

(mm)

Code	Range	Accuracy	L	a	b
3236-25B	0-25mm	4µm	32	6	24

DIGITAL OUTSIDE MICROMETERS WITH INTERCHANGEABLE ANVILS

IP65
WATERPROOF

DATA
OUTPUT



3506-400A

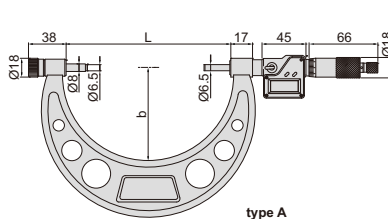

type A

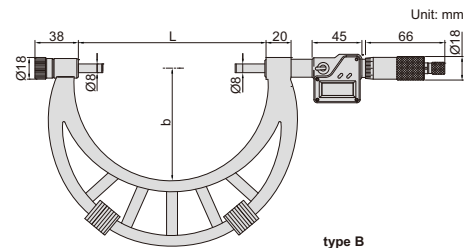

type B

Unit: mm

- Resolution 0.001mm/0.0001"
- IP65 dust/waterproof
- Button function: on/off, set, mm/inch, data transmit
- Data output
- Automatic power off
- Ratchet stop
- Carbide measuring faces
- Supplied with setting standards
- Optional accessory: data output cable (code 7315-30, 7302-30)

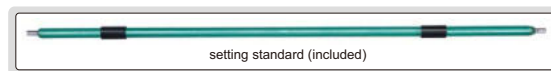

Code	Range	Type	Accuracy	L	b	Setting standard (included)
3506-300A	150-300mm/6-12"	A	±8µm	305	165	150, 175, 200, 225, 250, 275
3506-400A	300-400mm/12-16"	B	±9µm	405	224	325, 375
3506-500A	400-500mm/16-20"	B	±11µm	505	275	425, 475

(mm)

OUTSIDE MICROMETERS WITH INTERCHANGEABLE ANVILS

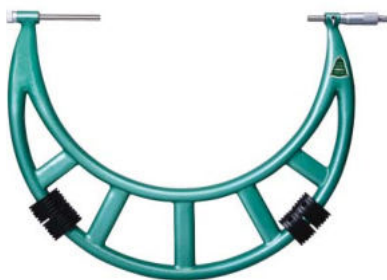

3206-400



3206-150A

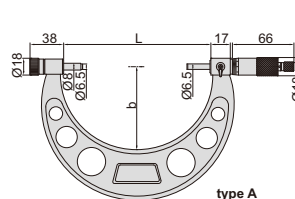

type A

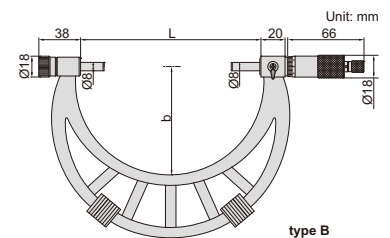

type B

Unit: mm



- Graduation 0.01mm
- Ratchet stop
- Meet DIN863-3
- Carbide measuring faces
- Supplied with setting standards

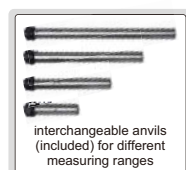

Code	Range	Type	Accuracy	L	b	Setting standard (included)
3206-150A	0-150mm	A	6µm	158	82	25, 50, 75, 100, 125
3206-200A	100-200mm	A	7µm	208	114	100, 125, 150, 175
3206-300A	150-300mm	A	9µm	308	165	150, 175, 200, 225, 250, 275
3206-301A	200-300mm	A	9µm	308	165	200, 225, 250, 275
3206-400	300-400mm	B	11µm	409	224	325, 375
3206-500	400-500mm	B	13µm	509	275	425, 475
3206-600	500-600mm	B	14µm	609	321	525, 575

(mm)

INDICATING MICROMETERS

ATTENTION: SETTING STANDARDS ARE NOT INCLUDED

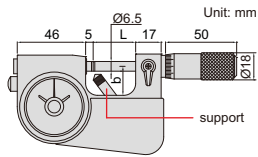

3332-25

- Meet DIN863-3
- Micrometer head graduation: 0.002mm
- Dial indicator: range ± 0.04 mm, graduation 0.001mm, accuracy 0.001mm
- Carbide measuring faces
- Optional accessory: gage blocks grade 0 (4101-A series), for zero setting

(mm)

Code	Micrometer head range	Micrometer head accuracy	L	b	Remark
3332-25	0-25mm	4 μ m	28.5	19	with support
3332-50	25-50mm	4 μ m	53.5	30	with support
3332-75	50-75mm	5 μ m	78.5	45	without support
3332-100	75-100mm	5 μ m	103.5	57	without support

MICROMETER WITH DIAL INDICATOR

ATTENTION: NOT SUITABLE FOR 0.001MM DIAL INDICATORS



3331-25A

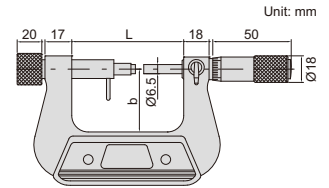

- Meet DIN863-3
- Micrometer head graduation 0.01mm
- Anvil retracting range: 8mm
- Carbide measuring faces
- Optional accessory: dial indicators (graduation 0.01mm), digital indicators (resolution 0.01mm/0.0005")

(mm)

Code	Micrometer head range	Micrometer head accuracy	L	b
3331-25A	0-25mm	4 μ m	67	38

GROOVE MICROMETER

- Measure width of grooves inside bores, measure width of keyway
- Graduation 0.01mm
- Two graduations for inside and outside measurements
- Non-rotating spindle
- Two-directional ratchet stop

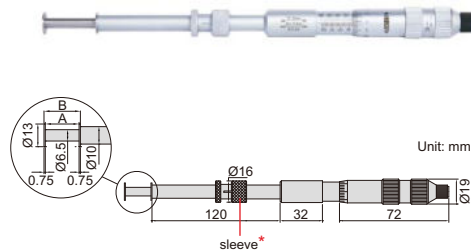
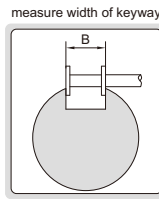

measure width of groove

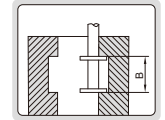

measure position of groove

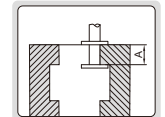

Code	Range (outside A)	Range (inside B)	Accuracy
3287-25B	0-25mm	1.6-26.5mm	10 μ m

3-WIRES



7382-19

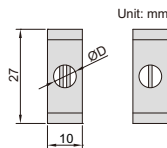

application



- Used with standard outside micrometers to measure pitch diameter of screw threads
- Diameter accuracy: $\pm 0.5\mu$ m
- Cylindricity: 1 μ m
- Hardness: HRC60
- Supplied with manufacturer inspection certificate

For outside micrometers with spindle $\text{Ø}6.50\text{mm}$ (ØD)

Code	Pin gage diameter (Ø)	Applicable pitch
7382-21	0.170mm	0.2mm, 0.25mm, 0.3mm
7382-22	0.195mm	0.35mm
7382-23	0.220mm	0.4mm
7382-24	0.250mm	0.45mm
7382-25	0.290mm	0.5mm
7382-26	0.335mm	0.6mm
7382-27	0.390mm	0.7mm
7382-28	0.455mm	0.75mm, 0.8mm
7382-29	0.530mm	0.9mm
7382-210	0.620mm	1.0mm
7382-211	0.725mm	1.25mm
7382-212	0.895mm	1.5mm
7382-213	1.100mm	1.75mm, 2.0mm
7382-214	1.350mm	2.5mm
7382-215	1.650mm	3.0mm
7382-216	2.050mm	3.5mm
7382-217	2.550mm	4mm, 4.5mm
7382-218	3.200mm	5mm, 5.5mm, 6mm
7382-2S	18 pairs/set, including all above 3-wires	

CARBIDE 3-WIRES

CUSTOMIZABLE
DIAMETER Ød

INSPECTION
CERTIFICATE

- When $\text{Ød} \leq 0.3\text{mm}$, length $L=25\text{mm}$;
- When $\text{Ød} > 0.3\text{mm}$, length $L=45\text{mm}$
- Made of carbide
- Hardness HRA90
- Diameter accuracy: $\pm 0.5\mu\text{m}$
- Roundness: $0.5\mu\text{m}$
- Cylindricity: $1\mu\text{m}$
- Supplied with manufacturer inspection certificate

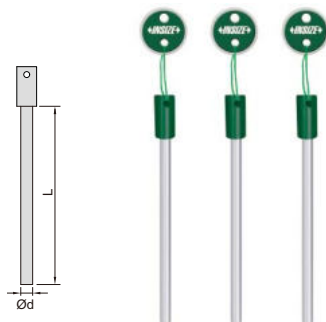

7394-76A

Code	Diameter (Ød)	Applicable pitch
7394-60A	0.170mm	0.2mm, 0.25mm, 0.3mm
7394-61A	0.195mm	0.35mm
7394-62A	0.220mm	0.4mm
7394-63A	0.250mm	0.45mm
7394-64A	0.290mm	0.5mm
7394-65A	0.335mm	0.6mm
7394-66A	0.390mm	0.7mm
7394-67A	0.455mm	0.75mm, 0.8mm
7394-68A	0.530mm	0.9mm
7394-69A	0.620mm	1.0mm
7394-70A	0.725mm	1.25mm
7394-71A	0.895mm	1.5mm
7394-72A	1.100mm	1.75mm, 2.0mm
7394-73A	1.350mm	2.5mm
7394-74A	1.650mm	3.0mm
7394-75A	2.050mm	3.5mm
7394-76A	2.550mm	4mm, 4.5mm
7394-77A	3.200mm	5mm, 5.5mm, 6mm

SCREW THREAD MICROMETERS

NON-ROTATING
SPINDLE



3281-25A
(measuring tips are optional)

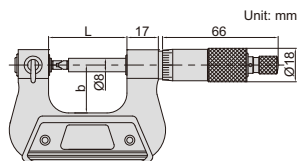

Unit: mm

- Measure pitch diameter of screw threads
- Graduation 0.01mm
- Non-rotating spindle
- Ratchet stop
- Supplied with 60° setting standards (except 0-25mm)
- Optional accessory: 55° setting standards, measuring tips (code 7381)



accuracy of micrometers with tips (mm)

Pitch	Range					
	0-25	25-50	50-75	75-100	100-125	125-150
0.4-0.5	±0.01	-	-	-	-	-
0.6-0.8	±0.01	±0.013	-	-	-	-
1-1.25	±0.012	±0.015	±0.017	±0.017	-	-
1.5-2.0	±0.014	±0.017	±0.019	±0.019	±0.020	±0.023
2.5-3.5	±0.016	±0.019	±0.021	±0.021	±0.023	±0.025
4.0-7.0	-	±0.021	±0.023	±0.023	±0.025	±0.028

(mm)

Code	Range	L	b	55° setting standard (optional)
3281-25A	0-25mm	42	26	-
3281-50A	25-50mm	67	38	3281-SP1
3281-75A	50-75mm	92	50	3281-SP2
3281-100A	75-100mm	117.6	62	3281-SP3
3281-125A	100-125mm	143	70	3281-SP4
3281-150A	125-150mm	168.2	82	3281-SP5

DIGITAL SCREW THREAD MICROMETERS

NON-ROTATING
SPINDLE

DATA
OUTPUT



3581-25A
(measuring tips are optional)

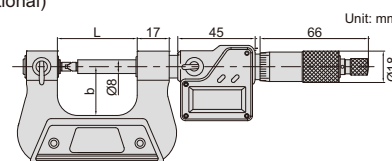

Unit: mm

- Measure pitch diameter of screw threads
- Resolution 0.001mm/0.00005"
- Button function: on/off, set, mm/inch, data transmit
- Data output
- Automatic power off
- Non-rotating spindle
- Ratchet stop
- Supplied with 60° setting standards (except 0-25mm/0-1")
- Optional accessory: 55° setting standards, measuring tips (code 7381), data output cable (code 7315-30, 7302-30)

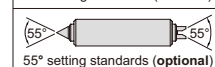
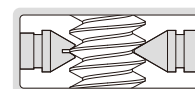

accuracy of micrometers with tips (mm)

Pitch	Range			
	0-25	25-50	50-75	75-100
0.4-0.5	±0.01	-	-	-
0.6-0.8	±0.01	±0.013	-	-
1-1.25	±0.012	±0.015	±0.017	±0.017
1.5-2.0	±0.014	±0.017	±0.019	±0.019
2.5-3.5	±0.016	±0.019	±0.021	±0.021
4.0-7.0	-	±0.021	±0.023	±0.023

(mm)

Code	Range	L	b	55° setting standard (optional)
3581-25A	0-25mm/0-1"	42	26	-
3581-50A	25-50mm/1-2"	67	38	3281-SP1
3581-75A	50-75mm/2-3"	92	50	3281-SP2
3581-100A	75-100mm/3-4"	117.6	62	3281-SP3

MEASURING TIPS FOR SCREW THREAD MICROMETERS



7381-T13

- Supplied in pairs
- Suitable for 3281, 3581 series micrometers

Metric and unified thread (60° thread angle)

Code	Pitch
7381-T11	0.4-0.5mm/64-48TPI
7381-T12	0.6-0.9mm/44-28TPI
7381-T13	1-1.75mm/24-14TPI
7381-T14	2-3mm/13-9TPI
7381-T15	3.5-5mm/8-5TPI
7381-T16	5.5-7mm/4.5-3.5TPI
7381-TS	6 pairs/set, including all above tips

Whitworth thread (55° thread angle)

Code	Pitch
7381-T2S	10 pairs/set: 60-48TPI, 48-40TPI, 40-32TPI, 32-24TPI, 24-18TPI, 18-14TPI, 14-10TPI, 10-7TPI, 7-4.5TPI, 4.5-3.5TPI, including all above tips

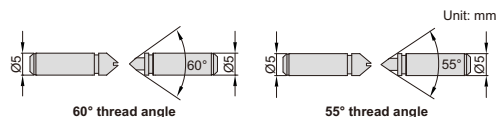

GEAR TOOTH MICROMETERS



3291-25

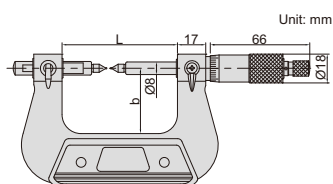

- Meet DIN863-3
- Measure over-pin diameter of gears
- Graduation 0.01mm
- Ratchet stop
- Supplied with setting standards (except 0-25mm)
- Optional accessory: ball tips (code 7391)

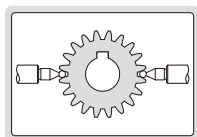

Code	Range	Accuracy	L	b
3291-25	0-25mm	4µm	67	38
3291-50	25-50mm	4µm	92.4	50
3291-75	50-75mm	5µm	117.6	62
3291-100	75-100mm	5µm	143	70

DIGITAL GEAR TOOTH MICROMETERS

IP65
WATERPROOF

DATA
OUTPUT



3591-25A

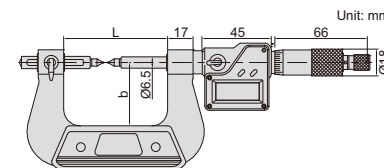

- Measure over-pin diameter of gears
- Resolution 0.001mm/0.00005"
- IP65 dust/waterproof
- Button function: on/off, set, mm/inch, data transmit
- Data output
- Automatic power off
- Ratchet stop
- Supplied with setting standards (except 0-25mm/0-1")
- Optional accessory: ball tips (code 7391), data output cable (code 7315-30, 7302-30)

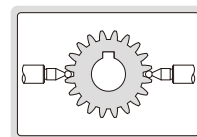

Code	Range	Accuracy	L	b
3591-25A	0-25mm/0-1"	±4µm	67	38
3591-50A	25-50mm/1-2"	±4µm	92.4	50
3591-75A	50-75mm/2-3"	±5µm	117.6	62
3591-100A	75-100mm/3-4"	±5µm	143	70

BALL TIPS FOR GEAR TOOTH MICROMETERS



7391-T5

- Supplied in pair
- Suitable for 3291, 3591 series micrometers

Code	Ball dia. (D)
7391-T2	SØ1.5mm
7391-T3	SØ2.0mm
7391-T4	SØ2.5mm
7391-T5	SØ3.0mm
7391-T6	SØ3.5mm

Code	Ball dia. (D)
7391-T7	SØ4.0mm
7391-T8	SØ4.5mm
7391-T9	SØ5.0mm
7391-T10	SØ6.0mm

POINT MICROMETERS



3230-25A

- Measure the web thickness of drills, small grooves and keyways
- Ratchet stop
- Carbide tips
- Supplied with setting standards (except 0-25mm)

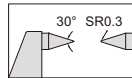
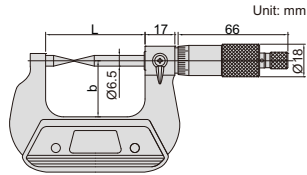

Code	Range	Accuracy	L	b
3230-25A	0-25mm	4µm	57	32
3230-50A	25-50mm	4µm	82	44.5
3230-75A	50-75mm	5µm	107	57
3230-100A	75-100mm	5µm	132.6	69.5

DIGITAL POINT MICROMETERS

IP65
WATERPROOF

DATA
OUTPUT



3530-25A

- Measure the web thickness of drills, small grooves and keyways
- Resolution 0.001mm/0.00005"
- IP65 dust/waterproof
- Button function: on/off, set, mm/inch, data transmit
- Data output
- Automatic power off
- Ratchet stop
- Carbide tips
- Supplied with setting standards (except 0-25mm/0-1")
- Optional accessory: data output cable (code 7315-30, 7302-30)

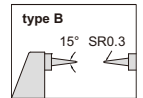
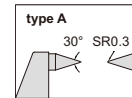
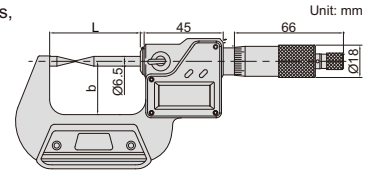

Code	Range	Type	Accuracy	L	b
3530-25A	0-25mm/0-1"	A	±4µm	57mm	32mm
3530-50A	25-50mm/1-2"	A	±4µm	82mm	44.5mm
3530-25BA	0-25mm/0-1"	B	±4µm	57mm	32mm
3530-50BA	25-50mm/1-2"	B	±4µm	82mm	44.5mm

BLADE MICROMETERS

NON-ROTATING
SPINDLE



3232-25A

- Meet DIN863-3
- Measure the groove diameter of shafts and keyways
- Graduation: 0.01mm
- Non-rotating spindle
- Ratchet stop
- Supplied with setting standards (except 0-25mm)

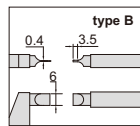
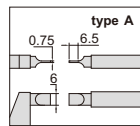
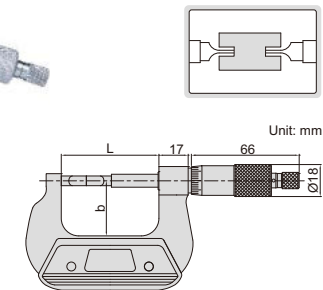

Code	Range	Type	Accuracy	L	b
3232-25A	0-25mm	A	4µm	57mm	32mm
3232-50A	25-50mm	A	4µm	82mm	44.5mm
3232-75A	50-75mm	A	5µm	107mm	57mm
3232-100A	75-100mm	A	5µm	132.6mm	69.5mm
3232-25BA	0-25mm	B	4µm	57mm	32mm

DIGITAL BLADE MICROMETERS

NON-ROTATING
SPINDLE

DATA
OUTPUT



3532-25A

- Measure the groove diameter of shafts and keyways
- Resolution 0.001mm/0.00005"
- Non-rotating spindle
- Button function: on/off, set, mm/inch, data transmit
- Data output, automatic power off
- Ratchet stop
- Supplied with setting standards (except 0-25mm/0-1")
- Optional accessory: data output cable (code 7315-30, 7302-30)

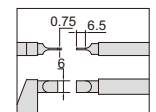
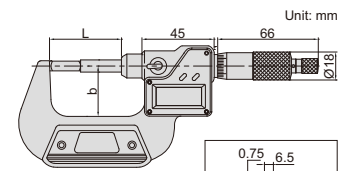

Code	Range	Accuracy	L	b
3532-25A	0-25mm/0-1"	±4µm	57	32
3532-50A	25-50mm/1-2"	±4µm	82	44.5

CRIMP HEIGHT MICROMETER



3266-25BA

- Measure the height of crimp contact
- Graduation 0.01mm
- Ratchet stop

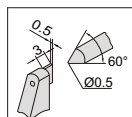
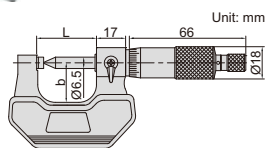

Code	Range	Accuracy	L	b
3266-25BA	0-25mm	4µm	34mm	24mm

DIGITAL CRIMP HEIGHT MICROMETER

IP65
WATERPROOF

DATA
OUTPUT



3566-25BA

- Measure the height of crimp contact
- Resolution 0.001mm/0.00005"
- IP65 dust/waterproof
- Button function: on/off, set, mm/inch, data transmit
- Data output, automatic power off
- Ratchet stop
- Optional accessory: data output cable (code 7315-30, 7302-30)

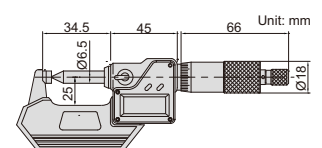

Code	Range	Accuracy
3566-25BA	0-25mm/0-1"	±4µm

SPLINE MICROMETER



3233-25A

- Meet DIN863-3
- Measure splined shafts, slots and keyways
- Graduation 0.01mm
- Ratchet stop
- Carbide measuring faces

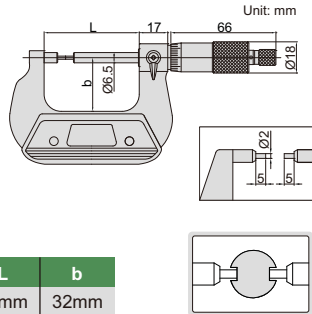

Code	Range	Accuracy	L	b
3233-25A	0-25mm	4µm	57mm	32mm

DIGITAL SPLINE MICROMETER

DATA OUTPUT

IP65 WATERPROOF



3533-25A

- Measure splined shafts, slots and keyways
- IP65 dust/waterproof
- Button function: on/off, set, mm/inch, data transmit
- Data output
- Automatic power off
- Ratchet stop
- Carbide measuring faces
- Optional accessory: data output cable (code 7315-30, 7302-30)

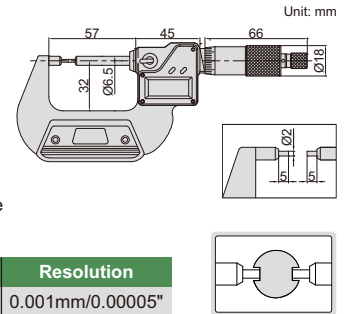

Code	Range	Accuracy	Resolution
3533-25A	0-25mm/0-1"	±4µm	0.001mm/0.00005"

CYLINDRICAL ANVIL TUBE MICROMETER



3261-25A

- Measure wall thickness of tubes
- Graduation 0.01mm
- Ratchet stop
- Carbide spindle tip

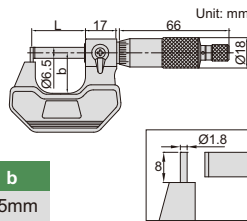

Code	Range	Accuracy	L	b
3261-25A	0-25mm	6µm	36mm	25mm

DIGITAL CYLINDRICAL ANVIL TUBE MICROMETER

IP65 WATERPROOF

DATA OUTPUT



3561-25A

- Measure wall thickness of tubes
- Resolution 0.001mm/0.00005"
- IP65 dust/waterproof
- Button function: on/off, set, mm/inch, data transmit
- Data output, automatic power off
- Ratchet stop
- Carbide spindle tip
- Optional accessory: data output cable (code 7315-30, 7302-30)

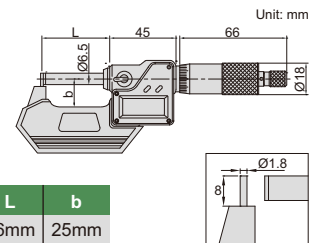

Code	Range	Accuracy	L	b
3561-25A	0-25mm/0-1"	±6µm	36mm	25mm

SPHERICAL ANVIL TUBE MICROMETERS



3260-25A

- Meet DIN863-3
- Measure wall thickness of tubes
- Graduation: 0.01mm
- Ratchet stop
- Carbide measuring faces
- Supplied with setting standards (except 0-25mm)

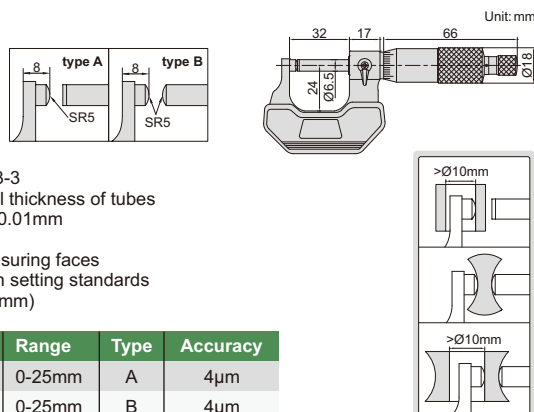

Code	Range	Type	Accuracy
3260-25A	0-25mm	A	4µm
3260-25SA	0-25mm	B	4µm

DIGITAL SPHERICAL ANVIL TUBE MICROMETERS

IP65 WATERPROOF

DATA OUTPUT



3560-25A

- Measure wall thickness of tubes
- Resolution 0.001mm/0.00005"
- IP65 dust/waterproof
- Button function: on/off, set, mm/inch, data transmit
- Data output, automatic power off
- Ratchet stop
- Carbide measuring faces
- Supplied with setting standards (except 0-25mm/0-1")
- Optional accessory: data output cable (code 7315-30, 7302-30)

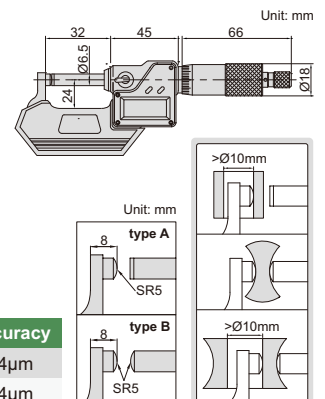

Code	Range	Type	Accuracy
3560-25A	0-25mm/0-1"	A	±4µm
3560-25SA	0-25mm/0-1"	B	±4µm

SHEET METAL MICROMETER

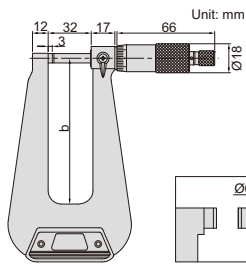

3239-253

- Deep frame suitable for sheet metal, paper and plastic
- Graduation 0.01mm
- Ratchet stop
- Carbide measuring faces

Code	Range	Accuracy	b
3239-253	0-25mm	7µm	155mm

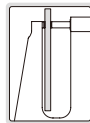

DIGITAL SHEET METAL MICROMETER

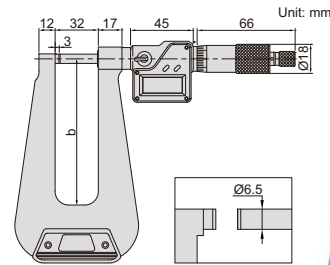

3539-253A

- Deep frame suitable for sheet metal, paper and plastic
- Resolution 0.001mm/0.00005"
- IP65 dust/waterproof
- Button function: on/off, set, mm/inch, data transmit
- Data output
- Automatic power off
- Ratchet stop
- Carbide measuring faces
- Optional accessory: data output cable (code 7315-30, 7302-30)

Code	Range	Accuracy	b
3539-253A	0-25mm/0-1"	±7µm	155mm

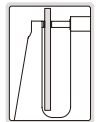

INTERCHANGEABLE ANVIL MICROMETERS



3262-25A

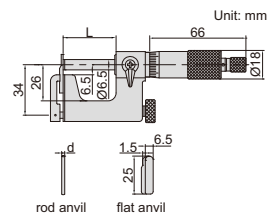

- Measure tube thickness, shoulder edge distance, rivet head height, etc.
- Supplied with flat anvil and rod anvil
- Graduation 0.01mm
- Ratchet stop
- Carbide spindle tip
- Setting standards are included (except 0-25mm)

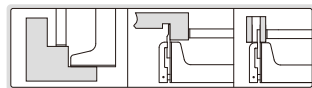

Code	Range	Accuracy	L	d
3262-25A	0-25mm	4µm	28.5mm	Ø3mm
3262-50A	25-50mm	4µm	53.5mm	Ø5mm

DIGITAL INTERCHANGEABLE ANVIL MICROMETERS



3562-25A

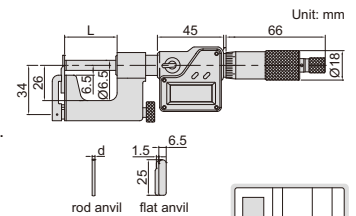

- Measure tube thickness, shoulder edge distance, rivet head height, etc.
- Supplied with flat anvil and rod anvil
- Resolution 0.001mm/0.00005"
- IP65 dust/waterproof
- Button function: on/off, set, mm/inch, data transmit
- Data output, automatic power off
- Ratchet stop
- Carbide spindle tip
- Setting standards are included (except 0-25mm/0-1")
- Optional accessory: data output cable (code 7315-30, 7302-30)

Code	Range	Accuracy	L	d
3562-25A	0-25mm/0-1"	±4µm	28.5mm	Ø3mm
3562-50A	25-50mm/1-2"	±4µm	53.5mm	Ø5mm

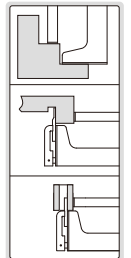

LARGE ANVIL MICROMETER



3234-25A

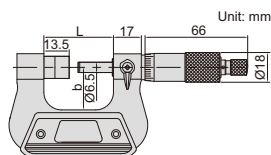

- Graduation 0.01mm
- Ratchet stop

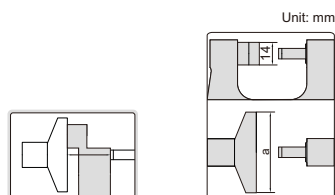

Code	Range	Accuracy	L	a	b
3234-25A	0-25mm	4µm	42mm	50mm	26mm

DIGITAL LARGE ANVIL MICROMETER



3534-25A

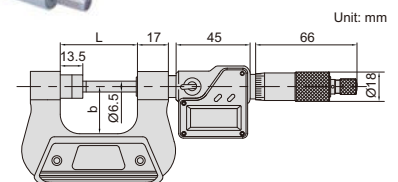

- Resolution 0.001mm/0.00005"
- IP65 dust/waterproof
- Button function: on/off, set, mm/inch, data transmit
- Data output
- Automatic power off
- Ratchet stop
- Optional accessory: data output cable (code 7315-30, 7302-30)

Code	Range	Accuracy	L	a	b
3534-25A	0-25mm/0-1"	±4µm	42	50	26

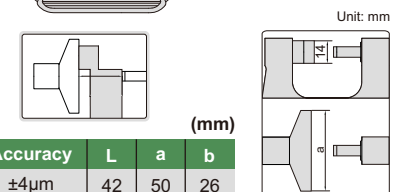

V-ANVIL MICROMETER



3290-153A

- Measure the diameter of parts or cutting tools with odd grooves, such as taps, reamers and end mills
- Graduation 0.01mm
- Ratchet stop
- Carbide measuring faces
- Supplied with setting standards

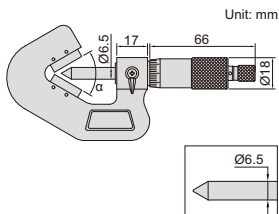

Unit: mm

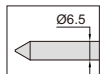

Code	Range	Flutes	Accuracy	α
3290-153A	1-15mm	3	4µm	60°

DIGITAL V-ANVIL MICROMETER

IP65
WATERPROOF

DATA
OUTPUT



3590-153A

- Measure the diameter of parts or cutting tools with odd grooves, such as taps, reamers and end mills
- Resolution 0.001mm/0.00005"
- IP65 dust/waterproof
- Button function: on/off, set, mm/inch, data transmit
- Data output, automatic power off
- Ratchet stop
- Carbide measuring faces
- Supplied with setting standards
- Optional accessory: data output cable (code 7315-30, 7302-30)

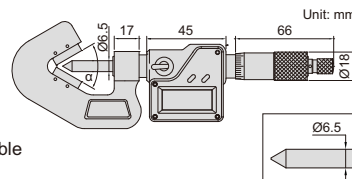

Unit: mm

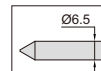

Code	Range	Flutes	Accuracy	α
3590-153A	1-15mm/0.04-0.6"	3	±4µm	60°

NON-ROTATING SPINDLE UNIVERSAL MICROMETER

NON-ROTATING
SPINDLE



3280-25A

Code	Range	Accuracy
3280-25A	0-25mm	4µm

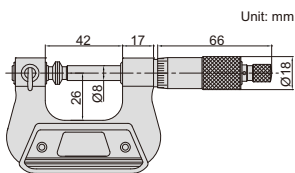

Unit: mm

- Meet DIN863-3
- Graduation 0.01mm
- Non-rotating spindle
- Ratchet stop
- Supplied with 7 pairs of anvil/spindle tip
- Optional accessory: 55° anvil/spindle tip (code 3280-SP1 and 3280-SP2)

Anvil/spindle tip (included) Unit: mm

Flat		Ø6.5	
Spherical		R5	
Spline		Ø2	
Disk		Ø12	
Blade		0.7	
Knife-edge		0.35	
Point		Ø0.3	

55° anvil/spindle tip (optional) Unit: mm

Code 3280-SP1 Knife-edge		0.35	
Code 3280-SP2 Point		Ø0.3	

DIGITAL UNIVERSAL MICROMETER

NON-ROTATING
SPINDLE

DATA
OUTPUT



3580-25A

Code	Range
3580-25A	0-25mm/0-1"

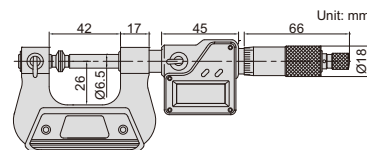

Unit: mm

- Accuracy: ±4µm
- Resolution 0.001mm/0.00005"
- Non-rotating spindle
- Button function: on/off, set, mm/inch, data transmit
- Data output, automatic power off
- Ratchet stop
- Supplied with 7 pairs of anvil/spindle tip
- Optional accessory: 55° anvil/spindle tip code 3280-SP1 and 3280-SP2, data output cable (code 7315-30, 7302-30)

Anvil/spindle tip (included) Unit: mm

Flat		Ø6.5	
Spherical		R5	
Spline		Ø2	
Disk		Ø12	
Blade		0.7	
Knife-edge		0.35	
Point		Ø0.3	

55° anvil/spindle tip (optional) Unit: mm

Code 3280-SP1 Knife-edge		0.35	
Code 3280-SP2 Point		Ø0.3	

DISK MICROMETERS

- Measure root tangent length of gear
- Graduation 0.01mm
- Ratchet stop
- Supplied with setting standards

Code	Range	Accuracy	Parallelism	L	b	c
3282-25	0-25mm	4µm	5µm	34	24	3.3
3282-50	25-50mm	4µm	5µm	59	32	3.3
3282-75	50-75mm	5µm	5µm	85	45	3.3
3282-100	75-100mm	5µm	5µm	110	57	3.3

(mm)



3282-25

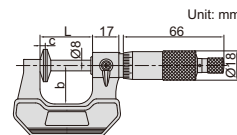

Unit: mm

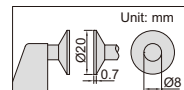
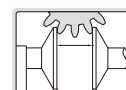

Unit: mm

DIGITAL NON-ROTATING SPINDLE DISK MICROMETERS

NON-ROTATING SPINDLE

DATA OUTPUT



3594-25A

- Measure root tangent length of gear
- Resolution 0.001mm/0.00005"
- Non-rotating spindle
- Button function: on/off, set, mm/inch, data transmit
- Data output
- Automatic power off
- Ratchet stop
- Supplied with setting standards
- Optional accessory: data output cable (code 7315-30, 7302-30)

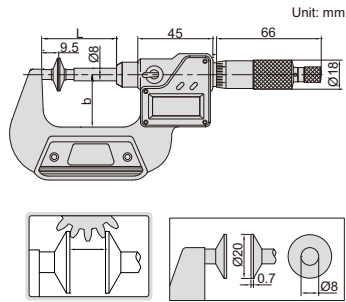

Code	Range	Accuracy	Parallelism	L	b
3594-25A	0-25mm/0-1"	±4µm	5µm	43mm	32mm
3594-50A	25-50mm/1-2"	±4µm	5µm	68mm	44.5mm
3594-75A	50-75mm/2-3"	±5µm	5µm	93mm	57mm
3594-100A	75-100mm/3-4"	±5µm	5µm	118.5mm	70mm

CALIPER TYPE MICROMETER



3238-25

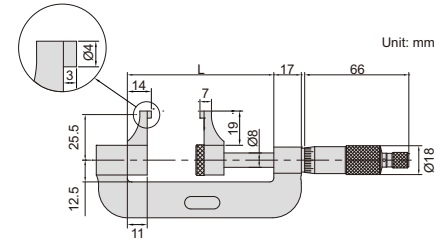
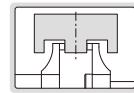

- Graduation 0.01mm
- Non-rotating spindle
- Ratchet stop
- Carbide measuring faces
- Supplied with setting standards (except 0-25mm)

Code	Range	Accuracy	L
3238-25	0-25mm	10µm	56mm

JAW TYPE MICROMETER

NON-ROTATING SPINDLE



3283-25A

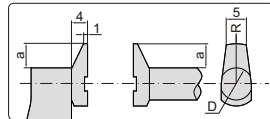
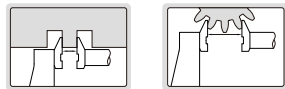
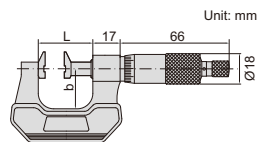

- Graduation 0.01mm
- Non-rotating spindle
- Ratchet stop

(mm)

Code	Range	Accuracy	L	a	b	R	D
3283-25A	0-25mm	4µm	34	6	24	10	8

DIGITAL JAW TYPE MICROMETER

NON-ROTATING SPINDLE

DATA OUTPUT



3583-25A

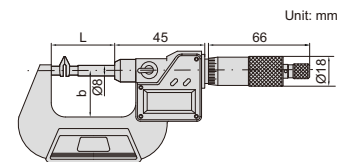
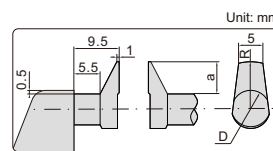

- Resolution 0.001mm/0.00005"
- Non-rotating spindle
- Button function: on/off, set, mm/inch, data transmit
- Data output
- Automatic power off
- Ratchet stop
- Optional accessory: data output cable (code 7315-30, 7302-30)

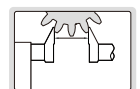
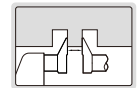

(mm)

Code	Range	Accuracy	L	a	b	R	D
3583-25A	0-25mm/0-1"	±4µm	43	6.5	32	10	8

WIRE MICROMETER

- Meet DIN863-3
- Measure diameter of wires and small balls
- Graduation 0.01mm
- Ratchet stop
- Carbide measuring faces



3285-10

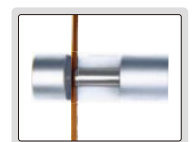
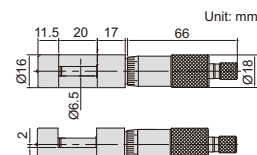

Code	Range	Accuracy
3285-10	0-10mm	4µm

CAN SEAM MICROMETERS



3293-131

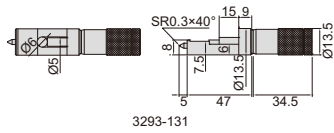

3293-132

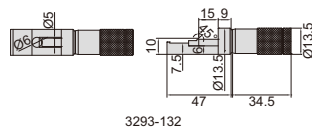

3293-133

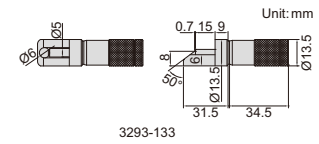

- Measure the width, height and depth of can seams
- Graduation 0.01mm

Code	Range	Accuracy
3293-131	0-13mm	4µm
3293-132	0-13mm	4µm
3293-133	0-13mm	4µm

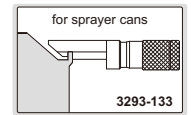
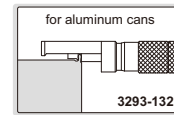
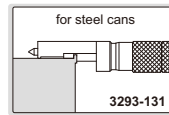

MICROMETER STAND



6300

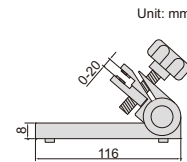

- Suitable for outside micrometers up to 100mm

Code
6300

MICROMETER STAND



6301

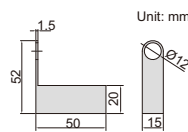

6301-1

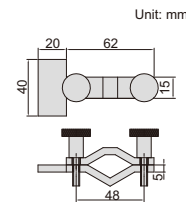

6301-2

- Suitable for outside micrometers up to 100mm

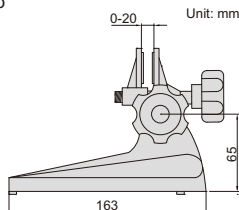

- Suitable for inside micrometers

Code	Description	Applicable products
6301-1	clamp for inside micrometers	all sizes of 3220 series

- Suitable for three points internal micrometers

Code	Description	Applicable products
6301-2	clamp for three points internal micrometers	up to 100mm of 3127 and 3227 series

MICROMETER SETTING STANDARDS



6310-100



Code	Length	Accuracy	D
6310-25	25	±1.5µm	Ø7
6310-50	50	±2µm	Ø7
6310-75	75	±2.5µm	Ø7
6310-100	100	±3µm	Ø8

(mm)

MICROMETER HEAD



6381-25W

- Meet DIN863-2
- Ratchet stop

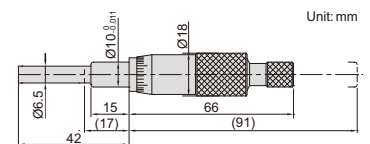

Code	Range	Stem	Spindle tip	Accuracy	Graduation
6381-25W	0-25mm	plain	flat (carbide)	3µm	0.01mm

PISTOL GRIP THREE POINTS BORE GAGES

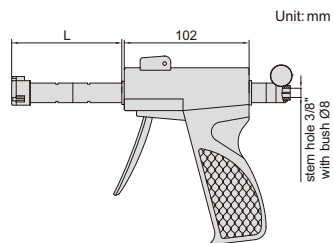

Unit: mm

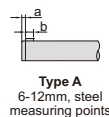

Type A
6-12mm, steel
measuring points

digital indicator
is optional

2124-8

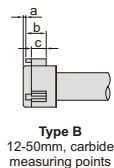

Type B
12-50mm, carbide
measuring points

digital indicator
is optional

2124-25

- Optional accessory:
digital indicators (code **2108-101F**,
resolution 0.001mm/0.00005")

setting ring (included)



extension rod (included)

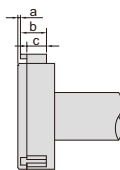

Type C
50-100mm, carbide
measuring points

digital indicator
is optional

2124-100

Individual

(mm)

Code	Range	Type	Accuracy (without digital indicator)	Setting ring (included)	Extension rod (included)	L	a	b	c
2124-8 *	6-8mm	A	4µm	Ø6mm	100mm	50	1.5	2.5	—
2124-10 *	8-10mm	A	4µm	Ø8mm	100mm	50	1.5	2.5	—
2124-12 *	10-12mm	A	4µm	Ø10mm	100mm	50	1.5	2.5	—
2124-16 *	12-16mm	B	4µm	Ø16mm	150mm	65	0.5	6	4.5
2124-20 *	16-20mm	B	4µm	Ø16mm	150mm	65	0.5	6	4.5
2124-25 *	20-25mm	B	4µm	Ø25mm	150mm	91	0.5	8	6
2124-30 *	25-30mm	B	4µm	Ø25mm	150mm	91	0.5	8	6
2124-40 *	30-40mm	B	4µm	Ø40mm	150mm	97	0.5	14	12
2124-50 *	40-50mm	B	5µm	Ø40mm	150mm	97	0.5	14	12
2124-63 *	50-63mm	C	5µm	Ø62mm	150mm	112	0.5	17.5	14.5
2124-75 *	62-75mm	C	5µm	Ø62mm	150mm	112	0.5	17.5	14.5
2124-88 *	75-88mm	C	5µm	Ø87mm	150mm	112	0.5	17.5	14.5
2124-100 *	87-100mm	C	5µm	Ø87mm	150mm	112	0.5	17.5	14.5

Set

Code	Range	Probes included	Setting ring (included)	Extension rod (included)
2124-S123 *	6-12mm	6-8mm, 8-10mm, 10-12mm	Ø6mm, Ø8mm, Ø10mm	100mm
2124-S202 *	12-20mm	12-16mm, 16-20mm	Ø16mm	150mm
2124-S504 *	20-50mm	20-25mm, 25-30mm, 30-40mm, 40-50mm	Ø25mm, Ø40mm	150mm
2124-S1004 *	50-100mm	50-63mm, 62-75mm, 75-88mm, 87-100mm	Ø62mm, Ø87mm	150mm



2124-S504

*Supplied with manufacturer inspection certificate

DIGITAL THREE POINTS INTERNAL MICROMETERS

INSPECTION
CERTIFICATE

IP65
WATERPROOF

DATA
OUTPUT



3127-12

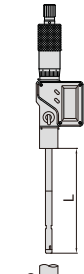

Type A
6-12mm, steel
measuring points
three points



3127-40

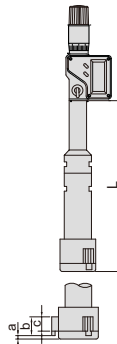

Type B
12-50mm, carbide
measuring points
three points



3127-125

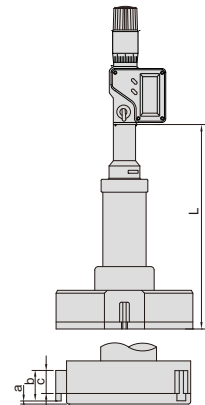

Type C
50-150mm, carbide
measuring points
three points

- Resolution 0.001mm/0.00005"
- IP65 dust/waterproof
- Buttons: on/off, set, mm/inch, data transmit
- Data output
- Automatic power off
- Ratchet stop
- Optional accessory:
data output cable (code 7315-30, 7302-30),
setting ring (code 6312), micrometer stand
and clamp (code 6301 and 6301-2)

micrometer stand
with clamp (optional)



setting ring



6-100mm: included
100-150mm: optional

extension rod



included

Individual

(mm)

Code	Range	Type	Accuracy	Setting ring	Extension rod (included)	L	a	b	c
3127-8 *	6-8mm/0.24-0.31"	A	4µm	Ø6mm (included)	100mm	57	1.5	2.5	—
3127-10 *	8-10mm/0.31-0.39"	A	4µm	Ø8mm (included)	100mm	57	1.5	2.5	—
3127-12 *	10-12mm/0.39-0.47"	A	4µm	Ø10mm (included)	100mm	57	1.5	2.5	—
3127-16 *	12-16mm/0.47-0.63"	B	4µm	Ø16mm (included)	150mm	99	0.5	6	4.5
3127-20 *	16-20mm/0.63-0.79"	B	4µm	Ø16mm (included)	150mm	99	0.5	6	4.5
3127-25 *	20-25mm/0.79-0.98"	B	4µm	Ø25mm (included)	150mm	105	0.5	8	6
3127-30 *	25-30mm/0.98-1.18"	B	4µm	Ø25mm (included)	150mm	105	0.5	8	6
3127-40 *	30-40mm/1.18-1.57"	B	4µm	Ø40mm (included)	150mm	110	0.5	14	12
3127-50 *	40-50mm/1.57-1.97"	B	5µm	Ø40mm (included)	150mm	110	0.5	14	12
3127-63 *	50-63mm/1.97-2.48"	C	5µm	Ø62mm (included)	150mm	127	0.5	17.5	14.5
3127-75 *	62-75mm/2.44-2.95"	C	5µm	Ø62mm (included)	150mm	127	0.5	17.5	14.5
3127-88 *	75-88mm/2.95-3.46"	C	5µm	Ø87mm (included)	150mm	127	0.5	17.5	14.5
3127-100 *	87-100mm/3.43-3.94"	C	5µm	Ø87mm (included)	150mm	127	0.5	17.5	14.5
3127-125 *	100-125mm/3.94-4.92"	C	5µm	optional	150mm	175	0.9	29	25
3127-150 *	125-150mm/4.92-5.91"	C	5µm	optional	150mm	175	0.9	29	25

Set

Code	Range	Micrometers included	Setting ring (included)	Extension rod (included)
3127-123 *	6-12mm/0.24-0.47"	6-8mm, 8-10mm, 10-12mm	Ø6mm, Ø8mm, Ø10mm	100mm
3127-202 *	12-20mm/0.47-0.79"	12-16mm, 16-20mm	Ø16mm	150mm
3127-504 *	20-50mm/0.79-1.97"	20-25mm, 25-30mm, 30-40mm, 40-50mm	Ø25mm, Ø40mm	150mm
3127-1004 *	50-100mm/1.97-3.94"	50-63mm, 62-75mm, 75-88mm, 87-100mm	Ø62mm, Ø87mm	150mm

*Supplied with manufacturer inspection certificate



3127-202

THREE POINTS INTERNAL MICROMETERS



- Meet DIN863-4
- 6-12mm: graduation 0.001mm, 12-200mm: graduation 0.005mm
- Ratchet stop
- Optional accessory: setting rings (code **6312**), micrometer stand and clamp (code **6301** and **6301-2**)

micrometer stand with clamp (optional)



3227-8

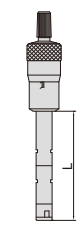

Type A
6-12mm, steel measuring points three points



3227-16

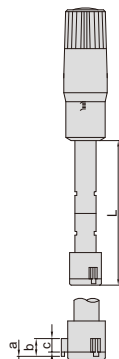

Type B
12-50mm, carbide measuring points three points



3227-125

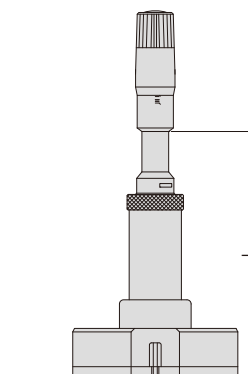

Type C
50-200mm, carbide measuring points three points

Individual

(mm)

Code	Range	Type	Accuracy	Setting ring	Extension rod (included)	L	a	b	c
3227-8 *	6-8mm	A	4µm	Ø6mm (included)	100mm	54.5	1.5	2.5	—
3227-10 *	8-10mm	A	4µm	Ø8mm (included)	100mm	54.5	1.5	2.5	—
3227-12 *	10-12mm	A	4µm	Ø10mm (included)	100mm	54.5	1.5	2.5	—
3227-16 *	12-16mm	B	4µm	Ø16mm (included)	150mm	80	0.5	6	4.5
3227-20 *	16-20mm	B	4µm	Ø16mm (included)	150mm	80	0.5	6	4.5
3227-25 *	20-25mm	B	4µm	Ø25mm (included)	150mm	90	0.5	8	6
3227-30 *	25-30mm	B	4µm	Ø25mm (included)	150mm	90	0.5	8	6
3227-40 *	30-40mm	B	4µm	Ø40mm (included)	150mm	97	0.5	14	12
3227-50 *	40-50mm	B	5µm	Ø40mm (included)	150mm	97	0.5	14	12
3227-63 *	50-63mm	C	5µm	Ø62mm (included)	150mm	114	0.5	17.5	14.5
3227-75 *	62-75mm	C	5µm	Ø62mm (included)	150mm	114	0.5	17.5	14.5
3227-88 *	75-88mm	C	5µm	Ø87mm (included)	150mm	114	0.5	17.5	14.5
3227-100 *	87-100mm	C	5µm	Ø87mm (included)	150mm	114	0.5	17.5	14.5
3227-125 *	100-125mm	C	5µm	optional	150mm	140	0.9	29	25
3227-150 *	125-150mm	C	5µm	optional	150mm	140	0.9	29	25
3227-175 *	150-175mm	C	7µm	optional	150mm	140	0.9	29	25
3227-200 *	175-200mm	C	7µm	optional	150mm	140	0.9	29	25

setting ring



6-100mm: included
100-200mm: optional

extension rod



included

Set

Code	Range	Micrometers included	Setting ring (included)	Extension rod (included)
3227-123 *	6-12mm	6-8mm, 8-10mm, 10-12mm	Ø6mm, Ø8mm, Ø10mm	100mm
3227-202 *	12-20mm	12-16mm, 16-20mm	Ø16mm	150mm
3227-504 *	20-50mm	20-25mm, 25-30mm, 30-40mm, 40-50mm	Ø25mm, Ø40mm	150mm
3227-1004 *	50-100mm	50-63mm, 62-75mm, 75-88mm, 87-100mm	Ø62mm, Ø87mm	150mm

* Supplied with manufacturer inspection certificate



3227-504

WIDE RANGE THREE POINTS INTERNAL MICROMETERS



- Meet DIN863-4
- Graduation 0.001mm
- Carbide measuring faces
- Ratchet stop
- Setting rings are included

Code	Range	Accuracy	Setting ring
3228-70 *	50-70mm	5µm	Ø50mm (included)
3228-100 *	70-100mm	5µm	Ø70mm (included)
3228-150 *	100-150mm	6µm	Ø100mm (included)
3228-250 *	150-250mm	8µm	Ø150mm (included)



setting ring



3228-70

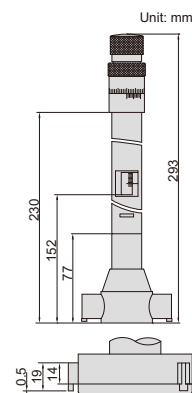

Unit: mm

* Supplied with manufacturer inspection certificate

DIGITAL WIDE RANGE THREE POINTS INTERNAL MICROMETERS

- Meet DIN863-4
- Resolution 0.001mm/0.00005" (resolution of 3128-300 is 0.001mm/0.0001")
- IP54 dust/waterproof
- Buttons: on/off, set, mm/inch, ABS/INC
- Data output, automatic power off
- Carbide measuring faces
- Ratchet stop
- Supplied with extension rods
- Setting rings are included (except 200-300mm)
- Optional accessory: data output cable (code 7315-30, 7302-30)



3128-70

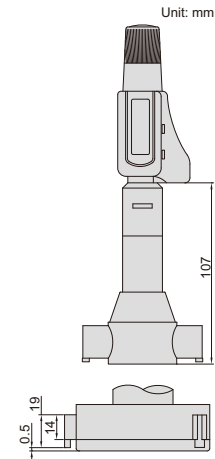

IP54
WATERPROOF

DATA
OUTPUT

Code	Range	Accuracy	Setting ring	Extension rod (included)
3128-70*	50-70mm/1.97-2.76"	5µm	Ø50mm (included)	150mm
3128-100*	70-100mm/2.76-3.94"	5µm	Ø70mm (included)	150mm
3128-150*	100-150mm/3.94-5.91"	6µm	Ø100mm (included)	150mm
3128-250*	150-250mm/5.91-9.84"	8µm	Ø150mm (included)	150mm
3128-300*	200-300mm/7.87-11.81"	9µm	Ø200mm (optional)	150mm

*Supplied with manufacturer inspection certificate

INSIDE MICROMETERS (ECONOMIC TYPE)

ATTENTION: LOW PARALLELISM OF TWO MEASURING FACES

Unit: mm

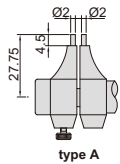

type A



3220-50

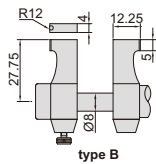

type B

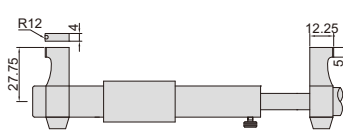

type C

micrometer stand with clamp (optional)



- Graduation 0.01mm
- Ratchet stop
- Carbide measuring faces
- Optional accessory: setting ring (code 6312), micrometer stand and clamp (code 6301 and 6301-1)

Code	Range	Type	Setting ring	Accuracy
3220-30	5-30mm	A	5mm (included)	7µm
3220-50	25-50mm	B	25mm (included)	8µm
3220-75	50-75mm	B	50mm (optional)	9µm
3220-100	75-100mm	C	75mm (optional)	10µm

DIGITAL INSIDE MICROMETERS (ECONOMIC TYPE)

ATTENTION: LOW PARALLELISM OF TWO MEASURING FACES



3520-30

DATA
OUTPUT

- Resolution 0.001mm/0.00005"
- Button function: on/off, set, mm/inch, data transmit
- Data output
- Automatic power off
- Ratchet stop
- Carbide measuring faces
- Optional accessory: data output cable (code 7315-30, 7302-30), setting ring (code 6312)

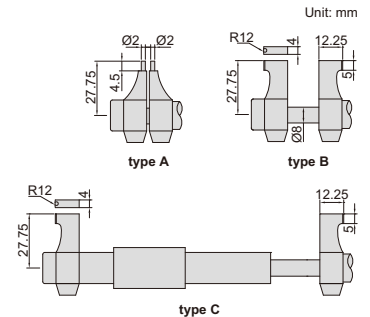

Code	Range	Type	Setting ring	Accuracy
3520-30	5-30mm/0.2-1.2"	A	5mm (included)	±5µm
3520-50	25-50mm/1-2"	B	25mm (included)	±6µm
3520-75	50-75mm/2-3"	B	50mm (optional)	±7µm
3520-100	75-100mm/3-4"	C	75mm (optional)	±8µm

DIGITAL TUBULAR INSIDE MICROMETERS

- Micrometer head: 150-175mm
- Graduation: 0.001mm/0.00005"
- Accuracy: $(3+n+L/50)\mu\text{m}$
n = number of rods
L = maximum measuring length (mm)
- Carbide measuring faces
- The diameter of extension rods is 22mm
- IP65 dust/waterproof
- Button function: on/off, set, mm/inch, data transmit
- Data output
- Automatic power off
- Supplied with setting standards
- Optional accessory: data output cable (code 7315-30, 7302-30)



3521-1000

IP65
WATERPROOF

DATA
OUTPUT

Code	Range	Travel of micrometer head	Extension rods
3521-175	150-175mm	25mm	—
3521-1000	150-1000mm	25mm	25mm, 50mm (2 pcs), 100mm, 200mm, 400mm

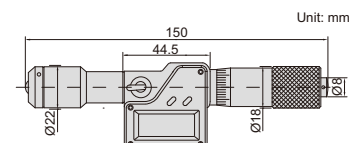

TUBULAR INSIDE MICROMETERS

- Graduation: 0.01mm
- Accuracy: $(6+L/50)\mu\text{m}$
L=maximum measuring length (mm)
- Optional accessory: setting ring (code 6312), gage block accessory (code 6881), cylinder gage block (code 4001), caliper/height gage checker (code 6884)



3221-50

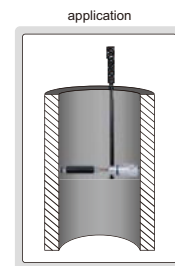
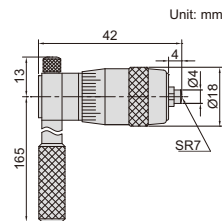

Code	Range	Travel of micrometer head	Extension rods
3221-50	25-50mm	7mm	2 pcs
3221-300	50-300mm	13mm	10 pcs

TUBULAR INSIDE MICROMETERS

- Micrometer head: 50-63mm
- Travel of micrometer head: 13mm
- Graduation: 0.01mm
- Accuracy: $(3+n+L/50)\mu\text{m}$
n=number of rods,
L=maximum measuring length (mm)
- Supplied with setting standards
- Carbide measuring faces

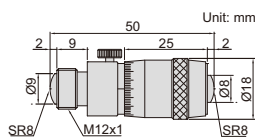

3222-150

Code	Range	Extension rods
3222-150	50-150mm	13mm, 25mm, 50mm
3222-300	50-300mm	13mm, 25mm, 50mm (2 pcs), 100mm
3222-500	50-500mm	13mm, 25mm, 50mm (2 pcs), 100mm, 200mm
3222-600	50-600mm	13mm, 25mm, 50mm, 100mm, 150mm, 200mm
3222-1000	50-1000mm	13mm, 25mm, 50mm (2 pcs), 100mm, 200mm (2 pcs), 300mm
3222-1500	50-1500mm	13mm, 25mm, 50mm (2 pcs), 100mm, 200mm (3 pcs), 300mm (2 pcs)

BORE GAGES

ATTENTION: NOT SUITABLE FOR 0.001MM DIAL INDICATORS

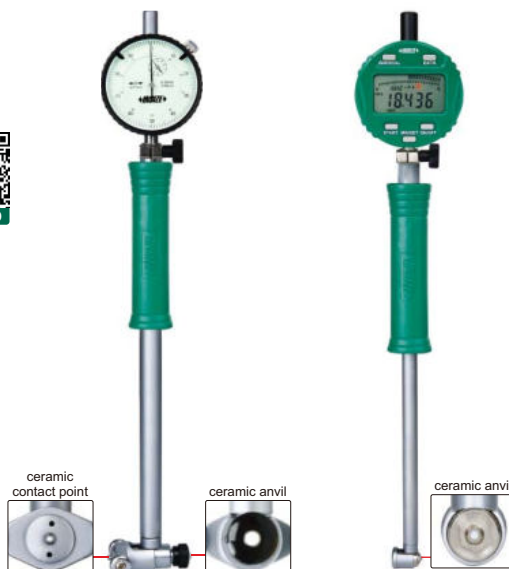
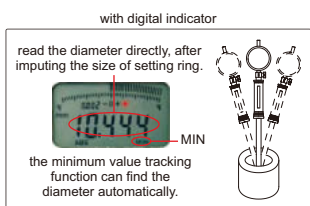
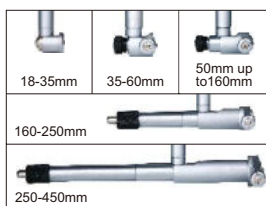

2322-160A

2122-35A

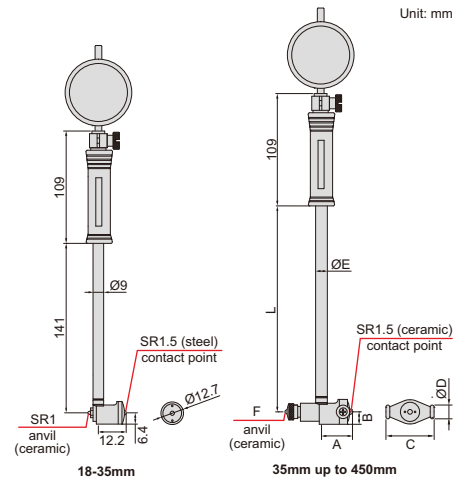

Range	A	B	C	ØD	ØE	F	L
35-60mm	22	9	27	13	12.8	SR2	141
50-100mm	26	9	35	13	12.8	SR2	141
50-160mm	26	9	35	13	12.8	SR2	141
100-160mm	26	9	35	13	12.8	SR2	141
160-250mm	56.5	13	74.5	15	12.8	SR2	241
250-450mm	86.5	15	101.5	15	14.5	SR2.5	241

- Repeatability: 0.003mm
- Optional accessory: setting ring (code 6312), long handle (code 7351), bore gage setter

With dial indicator

Code	Range	Indicator	Accuracy
2322-35A	18-35mm	dial indicator, range 10mm, graduation 0.01mm (code 2308-10FA)	±0.015mm
2322-60A	35-60mm		±0.018mm
2322-100A	50-100mm		±0.018mm
2322-160A	50-160mm		±0.018mm
2322-161A	100-160mm		±0.018mm
2322-250A	160-250mm		±0.018mm
2322-450A	250-450mm	±0.018mm	

With digital indicator (data output cable code 7315-50M, 7302-40M, optional)

Code	Range	Indicator	Accuracy
2122-35A	18-35mm	digital indicator, code 2108-10F, range 12.7mm/0.5", resolution 0.002mm/0.0001" (can switch to: 0.01mm/0.0005")	±0.015mm
2122-60A	35-60mm		±0.018mm
2122-160A	50-160mm		±0.018mm
2122-250A	160-250mm		±0.018mm
2122-450A	250-450mm		±0.018mm

PRECISION BORE GAGES

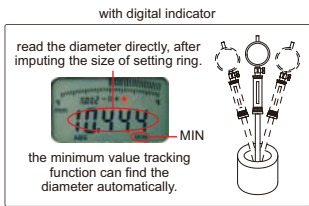
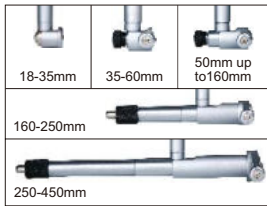

2825-160



2126-35

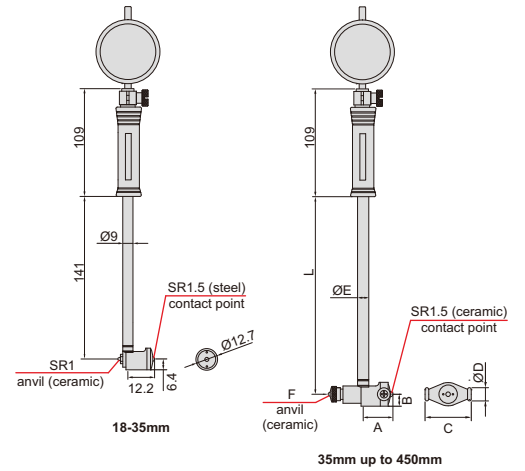

Range	A	B	C	ØD	ØE	F	L
35-60mm	22	9	27	13	12.8	SR2	141
50-100mm	26	9	35	13	12.8	SR2	141
50-160mm	26	9	35	13	12.8	SR2	141
100-160mm	26	9	35	13	12.8	SR2	141
160-250mm	56.5	13	74.5	15	12.8	SR2	241
250-450mm	86.5	15	101.5	15	14.5	SR2.5	241

- Optional accessory: setting ring (code 6312), long handle (code 7351), bore gage setter

With dial indicator

Code	Range	Indicator	Accuracy	Repeatability
2825-35	18-35mm	dial indicator, range 1mm, graduation 0.001mm (code 2313-1FA)	±0.007mm	0.0015mm
2825-60	35-60mm		±0.007mm	0.0015mm
2825-100	50-100mm		±0.007mm	0.0015mm
2825-160	50-160mm		±0.007mm	0.0015mm
2825-161	100-160mm		±0.007mm	0.0015mm
2825-250	160-250mm		±0.007mm	0.0015mm
2825-450	250-450mm		±0.007mm	0.0015mm

With digital indicator (data output cable code 7315-50M, 7302-40M, optional)

Code	Range	Indicator	Accuracy	Repeatability
2126-35	18-35mm	digital indicator, code 2108-101F, range 12.7mm/0.5", resolution 0.001mm/0.00005"	±0.007mm	0.002mm
2126-60	35-60mm		±0.007mm	0.002mm
2126-100	50-100mm		±0.007mm	0.002mm
2126-160	50-160mm		±0.007mm	0.002mm
2126-161	100-160mm		±0.007mm	0.002mm
2126-250	160-250mm		±0.007mm	0.002mm
2126-450	250-450mm		±0.007mm	0.002mm

BORE GAGES FOR SMALL HOLES

ATTENTION: NOT SUITABLE FOR 0.001MM DIAL INDICATORS

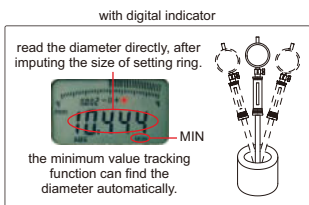

2852-10



2152-18

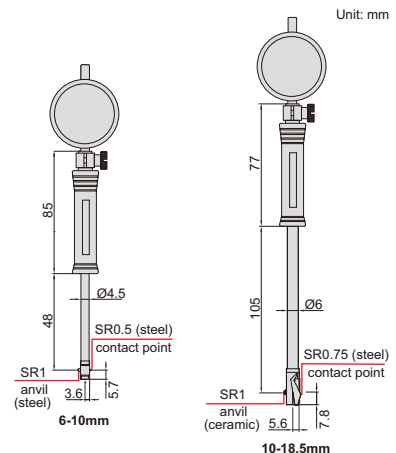

- Repeatability: 0.003mm
- Optional accessory: setting ring (code 6312), bore gage setter

With dial indicator

Code	Range	Indicator	Accuracy
2852-10	6-10mm	dial indicator, range 3mm, graduation 0.01mm (code 2311-3F)	±0.012mm
2852-18	10-18.5mm	dial indicator, range 3mm, graduation 0.01mm (code 2311-3F)	±0.012mm

With digital indicator (data output cable code 7315-50M, 7302-40M, optional)

Code	Range	Indicator	Accuracy
2152-10	6-10mm	digital indicator, code 2108-10F, range 12.7mm/0.5", resolution 0.002mm/0.0001" (can switch to: 0.01mm/0.0005")	±0.012mm
2152-18	10-18.5mm		±0.012mm

PRECISION BORE GAGES FOR SMALL HOLES

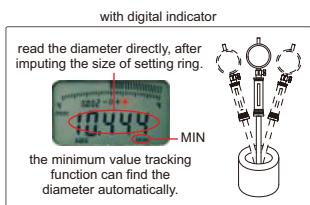

- Accuracy: $\pm 0.007\text{mm}$
- Optional accessory: setting ring (code 6312), bore gage setter

With dial indicator

Code	Range	Indicator	Repeatability
2853-10	6-10mm	dial indicator, range 1mm, graduation 0.001mm (code 2313-1FA)	0.0015mm
2853-18	10-18.5mm		0.0015mm

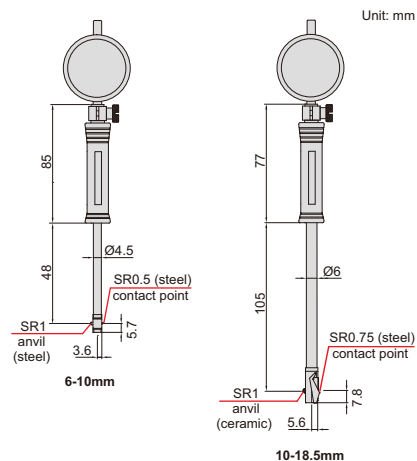
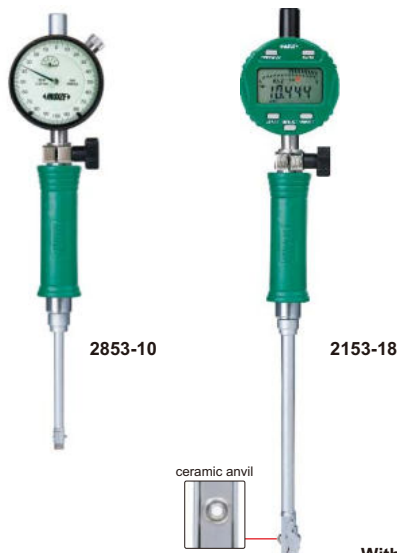

With digital indicator (data output cable code 7315-50M, 7302-40M, optional)

Code	Range	Indicator	Repeatability
2153-10	6-10mm	digital indicator, code 2108-101F, range 12.7mm/0.5", resolution 0.001mm/0.00005"	0.002mm
2153-18	10-18.5mm		0.002mm

BORE GAGE

ATTENTION: NOT SUITABLE FOR 0.001MM DIAL INDICATORS

Code	Range	Accuracy	Repeatability	Indicator
2828-800A	400-800mm	± 0.025	0.003	dial indicator, code 2308-10FA, range 10mm, graduation 0.01mm

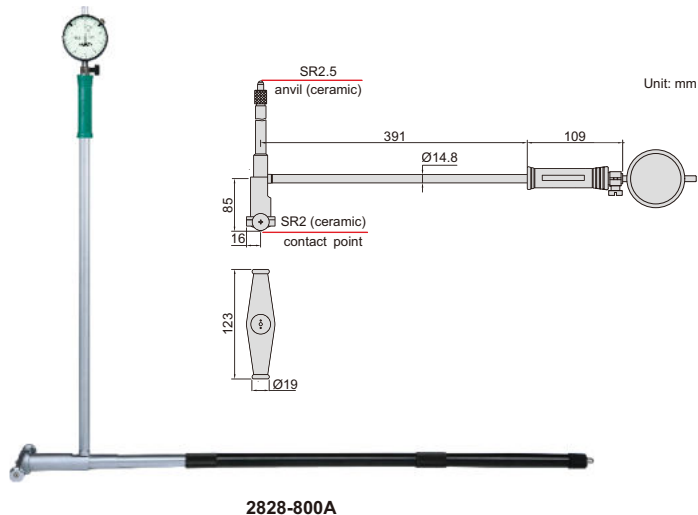

BORE GAGE SETS

ATTENTION: NOT SUITABLE FOR 0.001MM DIAL INDICATORS

- Repeatability: 0.003mm
- Optional accessory: setting ring (code 6312) long handle (code 7351)

packaging (code 2824-S3)



Code	Range	Indicator	Bore gages included	Accuracy
2824-S160	35-160mm	dial indicator, code 2308-10FA, range 10mm, graduation 0.01mm	① 35-50mm (dial indicator and handle are not included) ② 50-160mm	35-50mm $\pm 0.018\text{mm}$ 50-160mm $\pm 0.018\text{mm}$
2824-S3	18-160mm	dial indicator, code 2308-10FA, range 10mm, graduation 0.01mm	① 18-35mm ② 35-60mm (dial indicator is not included) ③ 50-160mm (dial indicator is not included)	18-35mm $\pm 0.015\text{mm}$ 35-60mm $\pm 0.018\text{mm}$ 50-160mm $\pm 0.018\text{mm}$



LONG HANDLES

method of use (replace the original handle with long handle)

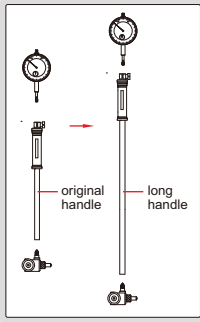

7351-EX11

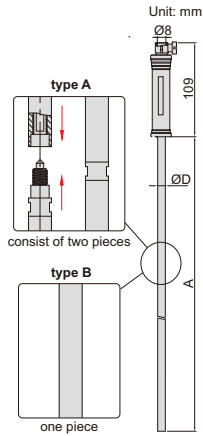

- To assist deep-hole measurement
- Can be used for bore gages 2322, 2122, 2824 and 2827

Code	Applicable bore gages	A	ØD	Type
7351-EX11	35-60mm, 50-100mm,	475mm	13mm	B
7351-EX12		980mm	13mm	
7351-EX13	50-160mm, 100-160mm	1480mm	14.5mm	A
7351-EX14		1980mm	14.5mm	
7351-EX21	160-250mm, 250-450mm	480mm	14.5mm	B
7351-EX22		980mm	14.5mm	
7351-EX23		1480mm	14.5mm	A
7351-EX24		1980mm	14.5mm	

BORE GAGE SETTERS

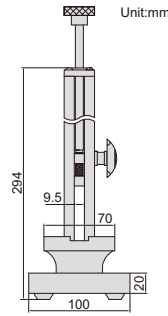

7353-160

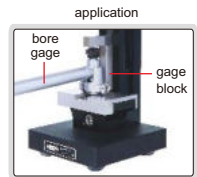

gage blocks for 7353-160



- Vertical and horizontal use
- To be used with gage blocks

Gage block set for 7353-160

Blocks per set	Size (mm)	Step (mm)	Quantity (pcs)	Remark
33	1.005		1	grade 2 (ISO3650)
	1.01-1.09	0.01	9	
	1.1-1.9	0.1	9	
	1-9	1	9	
	10-30	10	3	
	50		1	
	100		1	

horizontal use



Code	Range	Repeatability	Remark
7353-160	0-160mm	1.2µm	with gage block set
7353-160W	0-160mm	1.2µm	without gage block set

TELESCOPING GAGE SET



4206-1

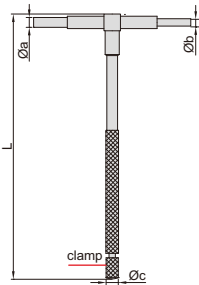

- 6 gages per set
- For quick measurement of inside diameter of holes and width of slots
- Satin chrome finish

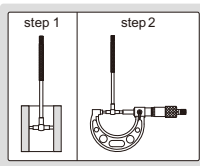

Range	L	Øa	Øb	Øc
8-12.7mm	115	3.9	2.9	6.2
12.7-19mm	115	5.3	3.8	6.2
19-32mm	115	5.3	3.8	6.2
32-54mm	137	7.6	6.1	7.2
54-90mm	137	7.6	6.1	7.2
90-150mm	137	7.6	6.1	7.2

Code	Total range	Gages included (mm)
4206-1	8-150mm	8-12.7, 12.7-19, 19-32, 32-54, 54-90, 90-150

SMALL HOLE GAGE SET

- 4 gages per set
- For small holes, slots and grooves, etc.
- Satin chrome finish



4208-1

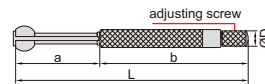
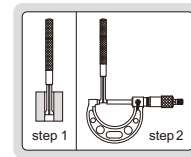

Range	L	a	b	ØD
3-5mm	76	24	52	5
5-7.5mm	79	27	52	5
7.5-10mm	88	30	58	6
10-13mm	91	34	58	6

Code	Total range	Gages included
4208-1	3-13mm	3-5mm, 5-7.5mm, 7.5-10mm, 10-13mm

LONG HANDLE TELESCOPING GAGES

- For quick measurement of inside diameter of deep holes and width of slots
- Satin chrome finish

Code	Range	L	Øa	Øb	Øc
4209-1	8-12.7mm	300	3.9	2.9	6.2
4209-2	12.7-19mm	300	5.3	3.8	6.2
4209-3	19-32mm	300	5.3	3.8	6.2
4209-4	32-54mm	300	7.6	6.1	7.2
4209-5	54-90mm	300	7.6	6.1	7.2
4209-6	90-150mm	300	7.6	6.1	7.2

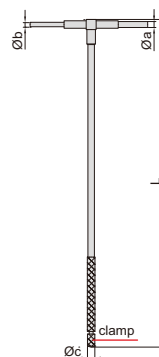

4209-6

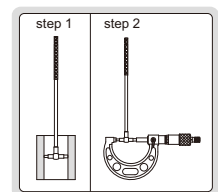

DIGITAL RADIUS GAGE (LOW ACCURACY)

ATTENTION: NO DATA OUTPUT

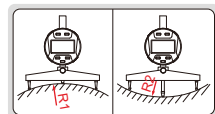

2183

- Resolution: 0.005mm/0.0002"
- Buttons: on/off, hold, mm/inch, s (select jaws), zero
- Measure radius of internal or external arcs
- Display can be rotated by 320°
- Supplied with 5 jaws for different sizes of arc
- Battery CR2032
- Automatic power off (time is adjustable)

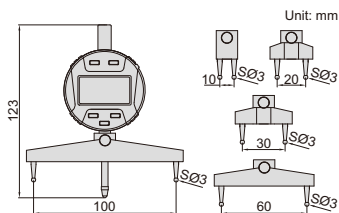

Code	Range of external radius (R1)	Range of internal radius (R2)	Accuracy (mm)
2183	5-910mm/0.2-35.83"	7-910mm/0.3-35.83"	±0.01R*

*R is the radius to be measured. For example, radius is 100mm, the accuracy is $\pm 0.01 \times 100 = \pm 1$ mm

DIGITAL RADIUS GAGE

DATA OUTPUT



2188-55

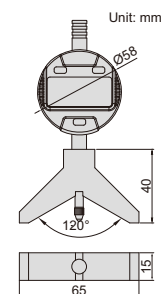

- Measure radius of external arc, arc angle of measured surface should be larger than 60°
- Display radius value, no need to calculate
- Button function: on/off, zero, data preset, inch/mm
- Keep preset data in memory after restart
- CR2032 battery
- Automatic power off (time is adjustable)
- Data output
- Stainless steel base
- Supplied with pin gage for zero setting
- Optional accessory: data output cable (code 7315-50M, 7302-40M)

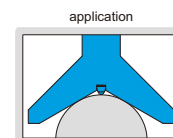

Code	Range (radius)	Resolution	Accuracy
2188-55	4-53mm/0.16-2.09"	0.01mm/0.0005"	±0.02mm

DIGITAL RADIUS CALIPERS

ATTENTION: THE ACTUAL RADIUS IS 2.414 TIMES OF THE READING

DATA OUTPUT

- Measure radius of external arc, arc angle of measured surface should be larger than 90°
- Resolution: 0.01mm/0.0005"
- Buttons: on/off, set, mm/inch, preset (+, -)
- Automatic power off, move the digital unit to turn on power
- Battery CR2032
- Data output
- Made of stainless steel
- Supplied with pin gage for zero setting



1501-25

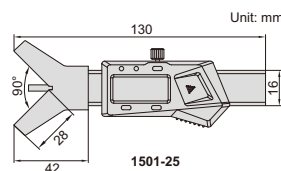

1501-25



1501-10

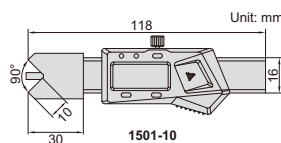

1501-10

Code	Range (radius)	Accuracy
1501-25	2-25mm/0.079-1"	±0.05mm
1501-10	2-10mm/0.079-0.394"	±0.05mm

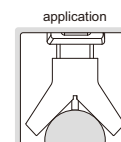

1501-10 can measure small workpieces or workpieces with steps

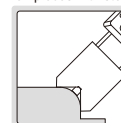

CIRCUMFERENCE TAPES

- Measure diameter and circumference of pipes, trees, tires, etc.
- Graduation: 0.1mm
- Laser engraved scale
- Made of stainless steel



7114-950

Code	Circumference range	Diameter range	Accuracy	
			Circumference	Diameter
7114-950	150-950mm	Ø50-300mm	±3mm	±1mm
7114-2200	940-2200mm	Ø300-700mm	±3mm	±1mm
7114-3460	2190-3460mm	Ø700-1100mm	±3mm	±1mm

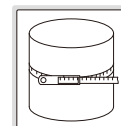
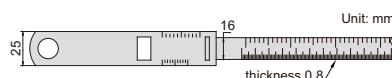

HIGH PRECISION DIGITAL INDICATORS

DATA OUTPUT **Ø28MM STEM SUITABLE FOR REINFORCED CLAMPING** **ABSOLUTE ENCODER, THE ORIGINAL DATA REMAINS AFTER POWER OFF**

LINEAR BALL BEARINGS FOR TEN MILLION TIMES USE **ATTENTION: RECHARGEABLE BATTERY, FOR 24 HOURS CONTINUOUS WORKING**

- Linear ball bearings for ten million times use
- Ø28mm stem suitable for reinforced clamping
- Absolute encoder, the original data remains after power off
- Adjustable resolution: 0.0002mm/0.00001" / 0.001mm/0.00005" / 0.01mm/0.0005"
- Reading in digital and analog
- Button function: data output, tolerance, data preset, data hold, measuring direction change, max./min./TIR, power off time, on/off, mm/inch, adjust resolution
- Power: rechargeable battery, for 24 hours continuous working
- Ruby probe

With data interface

Optional accessory:
 wireless transmitter, code **7315-60**,
 data output cable (keyboard format), code **7302-60**
 data output cable (serial port format), code **7305-G60**
 (cable length 3m, optional cable length maximum 15m; RS232 protocol, optional RS485 protocol)

Code	Range	Accuracy	Hysteresis	Remark
2140-6	0-6mm/0-0.24"	1.6µm	0.8µm	flat back



2140-6

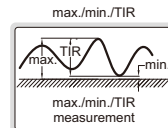
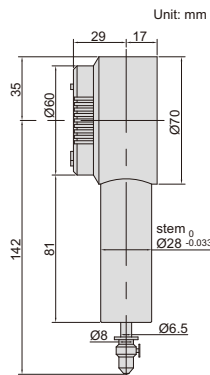

warning when over tolerance

over upper limit

over lower limit

analog pointer

analog pointer

wireless receiver 2134-R1, 2134-R2 (optional)

Built-in wireless

Optional accessory:
 wireless receiver (keyboard format, connect up to 15 digital indicators), code **2134-R1**
 wireless receiver (serial port format, connect up to 15 digital indicators), code **2134-R2**

Code	Range	Accuracy	Hysteresis	Remark
2140-6WL	0-6mm/0-0.24"	1.6µm	0.8µm	flat back

HIGH PRECISION DIGITAL INDICATORS



DATA OUTPUT **LINEAR BALL BEARINGS FOR TEN MILLION TIMES USE**

ATTENTION: RECHARGEABLE BATTERY, FOR 24 HOURS CONTINUOUS WORKING

ABSOLUTE ENCODER, THE ORIGINAL DATA REMAINS AFTER POWER OFF

- Linear ball bearings for ten million times use
- Absolute encoder, the original data remains after power off
- Reading in digital and analog
- Data output
- With flat back
- Button function: data output, tolerance, data preset, data hold, measuring direction change, max./min./TIR, power off time, on/off, mm/inch, adjust resolution
- Power: rechargeable battery, for 24 hours continuous working
- Optional accessory: contact points wireless transmitter, code **7315-60**
 data output cable (keyboard format), code **7302-60**
 data output cable (serial port format), code **7305-G60**
 (cable length 3m, optional cable length maximum 15m; RS232 protocol, optional RS485 protocol)

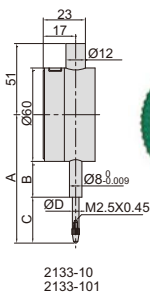

2133-10
2133-101



2133-10

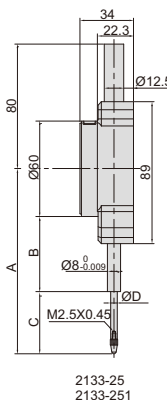

2133-25
2133-251



2133-25

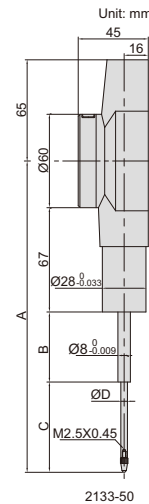

2133-50



2133-50

warning when over tolerance

over upper limit

over lower limit

analog pointer

analog pointer

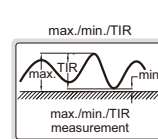

Low precision

Carbide probe
 Adjustable resolution: 0.0005mm/0.00002" / 0.001mm/0.00005" / 0.01mm/0.0005"

Code	Range	Accuracy	Hysteresis	A	B	C	ØD
2133-10*	12.7mm/0.5"	3µm	1.5µm	75.4	20.6	24.8	5
2133-25*	25.4mm/1"	3µm	1.5µm	109.5	38.5	41	5
2133-50*	50.8mm/2"	3µm	1.5µm	201	32	72	4.5

High precision

Ruby probe
 Adjustable resolution: 0.0002mm/0.00001" / 0.001mm/0.00005" / 0.01mm/0.0005"

Code	Range	Accuracy	Hysteresis	A	B	C	ØD
2133-101*	12.7mm/0.5"	1.5µm	1µm	77.4	26	21.4	4
2133-251*	25.4mm/1"	1.8µm	1µm	116.1	42.5	44	4

*Supplied with manufacturer inspection certificate

DIGITAL INDICATORS (STANDARD TYPE)

INSPECTION CERTIFICATE

DATA OUTPUT

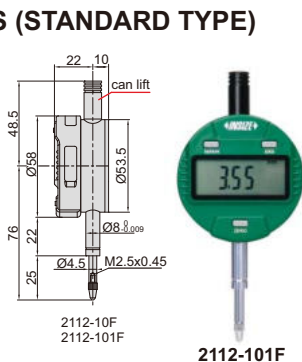

2112-10F
2112-101F

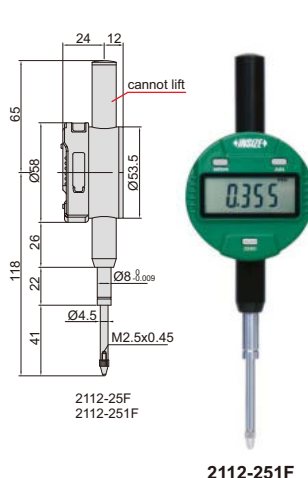

2112-25F
2112-251F



2112-50F
2112-501F

- Button function: on/off, inch/mm, zero, data preset, change measuring direction, absolute/incremental measurement
- Switchable high/low frequency measurement mode, high frequency mode is suitable for high speed moving of spindle and has large power consumption, low power consumption in low frequency mode
- Keep preset data in memory after restart
- CR2032 battery, automatic power off (time is adjustable), data output
- Optional accessory: data output cable (code 7315-50M, 7302-40M, 7305-40M), backs, contact points

spindle lift knob is included



Resolution 0.01mm/0.0005"

Code	Range	Accuracy	Hysteresis	Maximum measuring force	Remark
2112-10F*	12.7mm/0.5"	20µm	10µm	1.5N	flat back
2112-25F*	25.4mm/1"	20µm	10µm	2.2N	flat back
2112-50F*	50.8mm/2"	30µm	10µm	2.5N	flat back
2112-10*	12.7mm/0.5"	20µm	10µm	1.5N	lug back
2112-25*	25.4mm/1"	20µm	10µm	2.2N	lug back
2112-50*	50.8mm/2"	30µm	10µm	2.5N	lug back

*Supplied with manufacturer inspection certificate

Resolution 0.001mm/0.00005"

Code	Range	Accuracy	Hysteresis	Maximum measuring force	Remark
2112-101F*	12.7mm/0.5"	5µm	2µm	1.5N	flat back
2112-251F*	25.4mm/1"	5µm	3µm	2.2N	flat back
2112-501F*	50.8mm/2"	6µm	3µm	2.5N	flat back

DIGITAL INDICATORS (ADVANCED TYPE)

INSPECTION CERTIFICATE

DATA OUTPUT

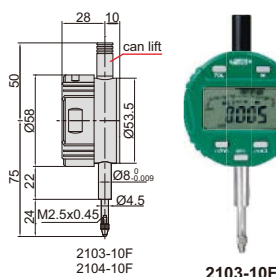

2103-10F
2104-10F

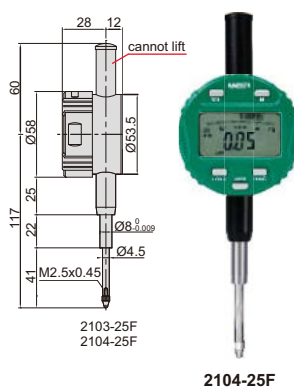

2104-25F

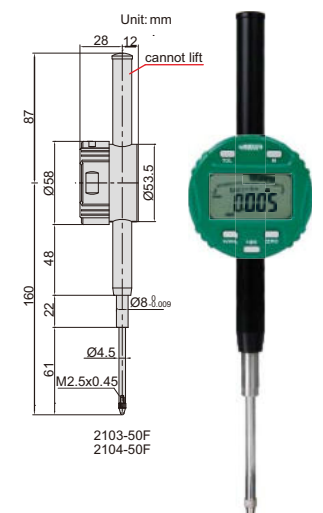

2103-50F
2104-50F

- Reading in digital and analog
- Display can be rotated by 320°
- Button function: tolerance Go and No-Go display, data preset, measuring direction change, max./min./TIR measurement, inch/metric conversion, absolute/incremental measurement
- Keep preset data and tolerance data in memory after restart
- CR2032 battery, automatic power off (time is adjustable)
- Data output
- Optional accessory: data output cable (code 7315-50M, 7302-40M, 7305-40M), backs, contact points

Resolution 0.001mm/0.00005"

Code	Range	Accuracy	Hysteresis	Maximum measuring force	Remark
2103-10F*	12.7mm/0.5"	5µm	2µm	1.5N	flat back
2103-25F*	25.4mm/1"	5µm	3µm	2.2N	flat back
2103-50F*	50.8mm/2"	6µm	3µm	2.5N	flat back

*Supplied with manufacturer inspection certificate

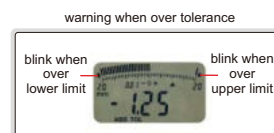
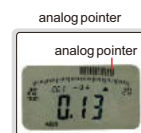
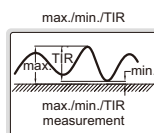

Resolution 0.01mm/0.0005"

Code	Range	Accuracy	Hysteresis	Maximum measuring force	Remark
2104-10F*	12.7mm/0.5"	20µm	10µm	1.5N	flat back
2104-25F*	25.4mm/1"	20µm	10µm	2.2N	flat back
2104-50F*	50.8mm/2"	30µm	10µm	2.5N	flat back

DIGITAL INDICATORS (WITH TRANSMISSION BUTTON AND SIGNAL LIGHT)

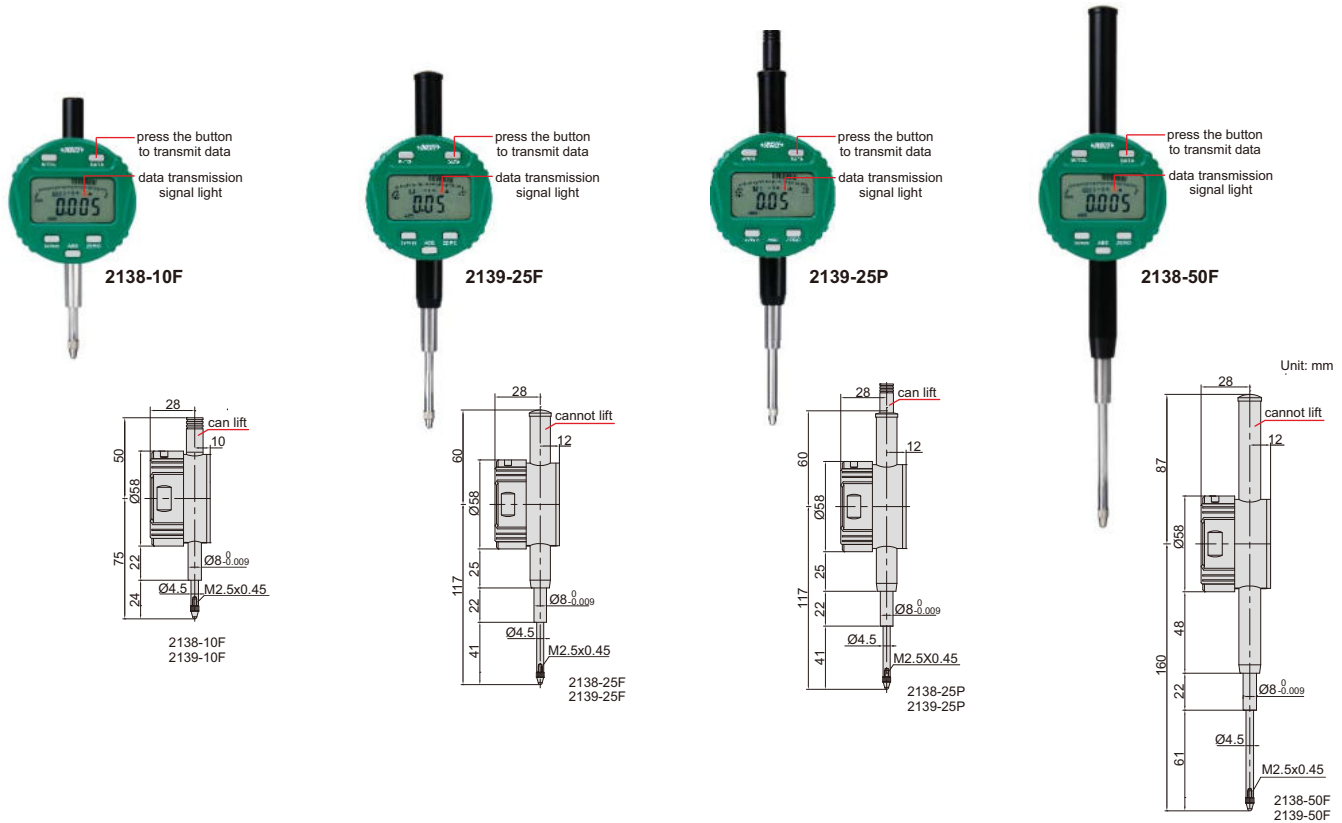

- Reading in digital and analog
- Display can be rotated by 320°
- Button function: on/off, zero, tolerance Go and No-Go display, data preset, measuring direction change, max./min./TIR measurement, inch/metric conversion, absolute/incremental measurement, data output
- Keep preset data and tolerance data in memory after restart
- CR2032 battery, automatic power off (time is adjustable)
- Data output
- Optional accessory: data output cable (code 7315-50M, 7302-40M, 7305-40M), backs, contact points

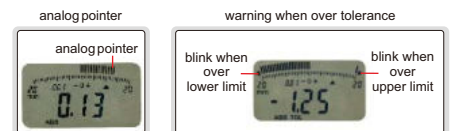

Resolution 0.001mm/0.0005"

Code	Range	Accuracy	Hysteresis	Maximum measuring force	Remark
2138-10F*	12.7mm/0.5"	5µm	2µm	1.5N	flat back
2138-25F*	25.4mm/1"	5µm	3µm	2.2N	flat back
2138-50F*	50.8mm/2"	6µm	3µm	2.5N	flat back
2138-25P*	25.4mm/1"	5µm	3µm	2.2N	flat back, with lift cap
2138-50P*	50.8mm/2"	6µm	3µm	2.5N	flat back, with lift cap

Resolution 0.01mm/0.0005"

Code	Range	Accuracy	Hysteresis	Maximum measuring force	Remark
2139-10F*	12.7mm/0.5"	20µm	10µm	1.5N	flat back
2139-25F*	25.4mm/1"	20µm	10µm	2.2N	flat back
2139-50F*	50.8mm/2"	30µm	10µm	2.5N	flat back
2139-25P*	25.4mm/1"	20µm	10µm	2.2N	flat back, with lift cap
2139-50P*	50.8mm/2"	30µm	10µm	2.5N	flat back, with lift cap

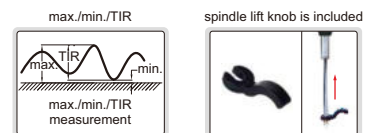

*Supplied with manufacturer inspection certificate

WATERPROOF DIGITAL INDICATORS

INSPECTION CERTIFICATE

WATERPROOF

DATA OUTPUT

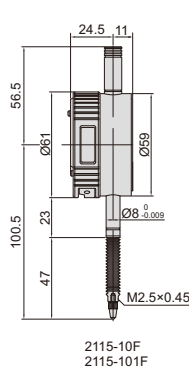

2115-10F

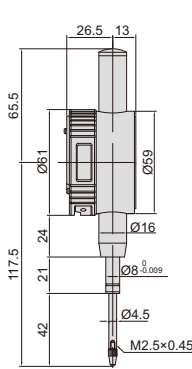

2115-25F

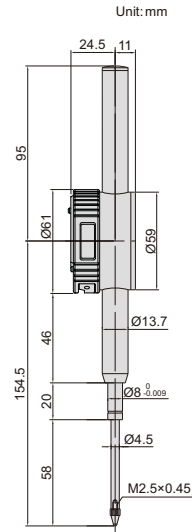

2115-50F

spindle lift knob is included (except 2115-101F, 2115-10F)

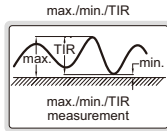

Resolution 0.001mm/0.00005"

Code	Range	Dust/waterproof	Accuracy	Hysteresis	Remark
2115-101F*	12.7mm/0.5"	IP65	5µm	2µm	flat back
2115-251F*	25.4mm/1"	IP54	5µm	3µm	flat back
2115-501F*	50.8mm/2"	IP54	6µm	3µm	flat back

Resolution 0.01mm/0.0005"

Code	Range	Dust/waterproof	Accuracy	Hysteresis	Remark
2115-10F*	12.7mm/0.5"	IP65	20µm	10µm	flat back
2115-25F*	25.4mm/1"	IP54	20µm	10µm	flat back
2115-50F*	50.8mm/2"	IP54	30µm	10µm	flat back

*Supplied with manufacturer inspection certificate

- Dust/waterproof
- Button function: on/off, zero, mm/inch, data preset, tolerance, change measuring direction, max./min./TIR measurement, absolute/incremental measurement
- Keep preset data and tolerance data in memory after restart
- CR2032 battery, automatic power off
- Data output
- Optional accessory: data output cable (code 7315-50M, 7302-40M, 7305-40M), backs, contact points

warning when over tolerance



DIGITAL INDICATOR FOR BORE GAGES (WITH TRANSMISSION BUTTON AND SIGNAL LIGHT)

THE ORIGINAL DATA REMAINS AFTER POWER OFF

DATA OUTPUT

INSPECTION CERTIFICATE



display can be rotated by 320°

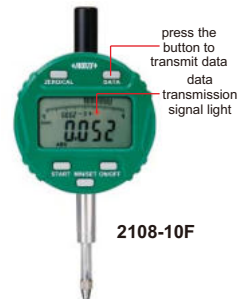
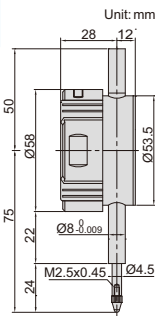

2108-10F

- Specially designed for bore gages
- The minimum value tracking function can find the diameter automatically
- Read the diameter directly, after inputting the size of setting ring
- Reading in digital and analog
- Display can be rotated by 320°
- Button function: on/off, minimum value tracking, calibration, data preset, inch/metric conversion
- Data remains after power off, no need to recalibrate after power on
- CR2032 battery
- Automatic power off (time is adjustable)
- Data output, with flat back
- Optional accessory: data output cable (code 7315-50M, 7302-40M, 7305-40M), backs, contact points, spindle lift knob

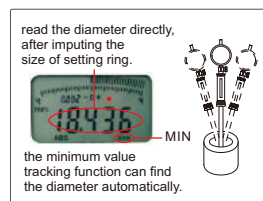
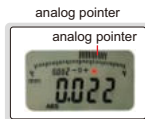

Code	Range	Resolution	Accuracy	Hysteresis
2108-10F*	12.7mm/0.5"	0.002mm/0.0001" (can switch to: 0.01mm/0.0005")	20µm	10µm

*Supplied with manufacturer inspection certificate

COMPACT DIGITAL INDICATOR

INSPECTION CERTIFICATE

DATA OUTPUT

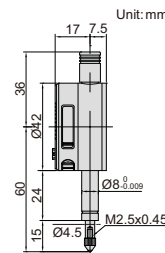

2114-5F

- Button function:
 - in/mm: short press for inch/metric conversion
 - long press to change measuring direction
 - ABS: short press for absolute/incremental measurement
 - long press to preset data
 - 0/ON: short press to turn on when power is off
 - short press to set zero when power is on
 - long press to turn off
- Keep preset data in memory after restart
- CR1632 battery, automatic power off
- Data output, with flat back
- Optional accessory: data output cable (code 7315-50M, 7302-40M, 7305-40M), contact points

Code	Range	Resolution	Accuracy	Hysteresis
2114-5F*	5mm/0.2"	0.01mm/0.0005"	20µm	10µm

*Supplied with manufacturer inspection certificate

BACK PLUNGER TYPE DIGITAL INDICATOR

**INSPECTION
CERTIFICATE**

**DATA
OUTPUT**

- Display can rotate 320°, and display direction is changeable
- Reading in digital and analog
- Button function: tolerance Go and No-Go display, data preset, measuring direction change, max./min./TIR measurement, inch/metric conversion, absolute/incremental measurement
- Keep preset data and tolerance data in memory after restart
- CR2032 battery, automatic power off (time is adjustable)
- Data output, with flat back
- Optional accessory: data output cable (code **7315-50M**, **7302-40M**, **7305-40M**), backs, contact points



2118-10

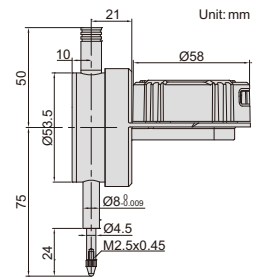

remark: to change above direction, 4 fixing screws on the back of display need to be removed first.

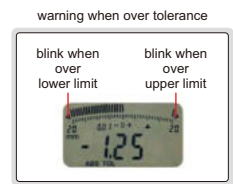
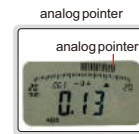
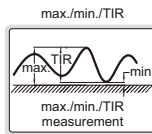

Code	Range	Resolution	Accuracy	Hysteresis
2118-10*	12.7mm/0.5"	0.01mm/0.0005"	20µm	10µm

*Supplied with manufacturer inspection certificate

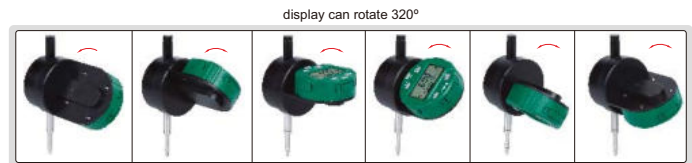

LARGE STROKE DIGITAL INDICATORS

**DATA
OUTPUT**

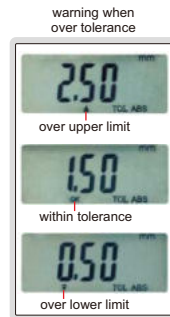
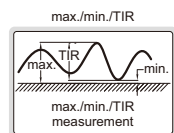

- Button function: on/off, zero, mm/inch, data preset, tolerance, change measuring direction, max./min./TIR measurement, absolute/incremental measurement
- Keep preset data and tolerance data in memory after restart
- CR2032 battery, automatic power off
- Maximum measuring force: 3.2N
- Data output
- Optional accessory: data output cable (code **7315-50M**, **7302-40M**, **7305-40M**), backs, contact points

Resolution 0.01mm/0.0005"

Code	Range	Accuracy	Hysteresis	Remark
2117-100	100mm/4"	30µm	10µm	lug back

Resolution 0.001mm/0.00005"

Code	Range	Accuracy	Hysteresis	Remark
2117-1001	100mm/4"	9µm	3µm	lug back



2117-100

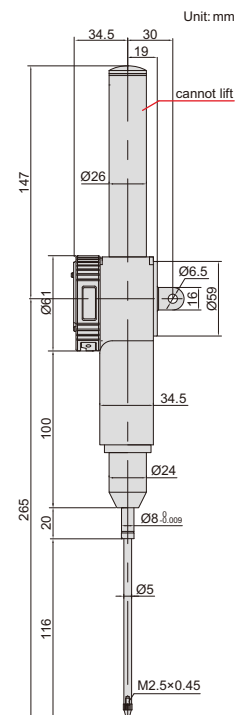

LINEAR GAGES

LINEAR GAGE
IP65
WATERPROOF

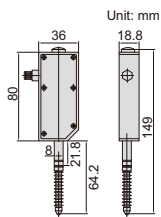

7107-11

SPECIFICATION

Code	7107-11	7107-12
Measuring range	12mm/0.47"	12mm/0.47"
Resolution	0.01mm/0.0004"	0.001mm/0.00004"
Accuracy	20µm	5µm
Hysteresis	10µm	2µm
Measuring principle	capacitance type linear encoder	
Voltage	5V	
Sampling frequency	100 times/sec.	
Working life	ten million times	
Dust/waterproof	IP65	
Measuring force	1.5N	
Cable length	2m	
Data output	RS232	

- Capacitance type linear encoder
- Shock-proof, water proof, dust proof, suitable for high speed movement, long working life
- Optional: display unit **7106-1A**, multichannel interface box **7107-1** or **7107-2**

DISPLAY UNIT CODE 7106-1A

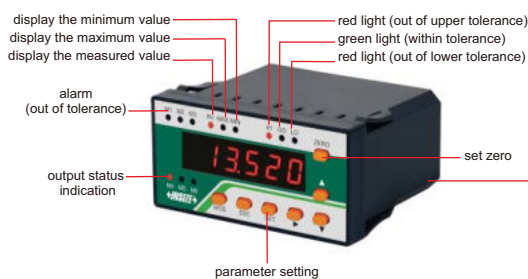

7106-1A

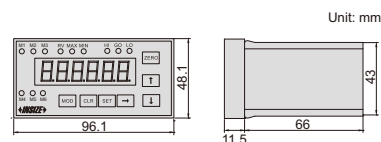
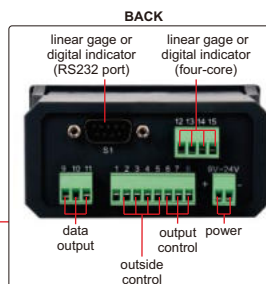

- Can be connected with **7107-11** or **7107-12** linear gage, can also be connected with digital indicator (data cable **7309-C01M** is needed)
- Set tolerance and make judgment (out of upper tolerance, within tolerance, out of lower tolerance), output the judgment to control outside devices, control from outside (set zero, hold reading and collect data)
- Software of display unit (included): in the software, it is possible to set tolerance and show judgment (red when out of tolerance, green when within tolerance), set zero, collect data manually or automatically (time is adjustable), output data to Excel, print report

SPECIFICATION

Code	7106-1A
Display	6 digits
Quantity of linear gage or digital indicator to be connected	1 pc
Tolerance	set tolerance and make judgment with alarm and lights (out of upper tolerance, within tolerance, out of lower tolerance)
Output control	output the tolerance judgment (out of upper tolerance, within tolerance, out of lower tolerance) to control outside devices
Outside control	control the display units from outside (set zero, hold reading and collect data)
Data output	connect to computer software and serial communication
Power supply	DC 9~24V

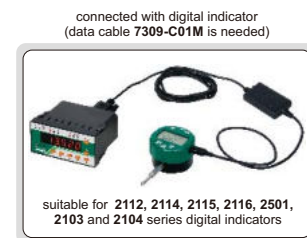
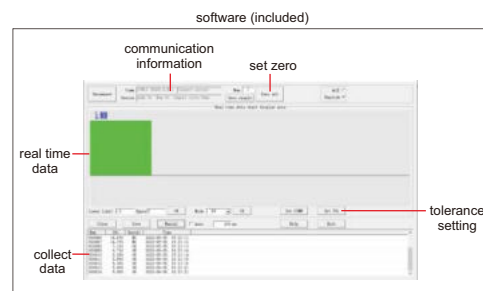



MULTICHANNEL INTERFACE BOXES

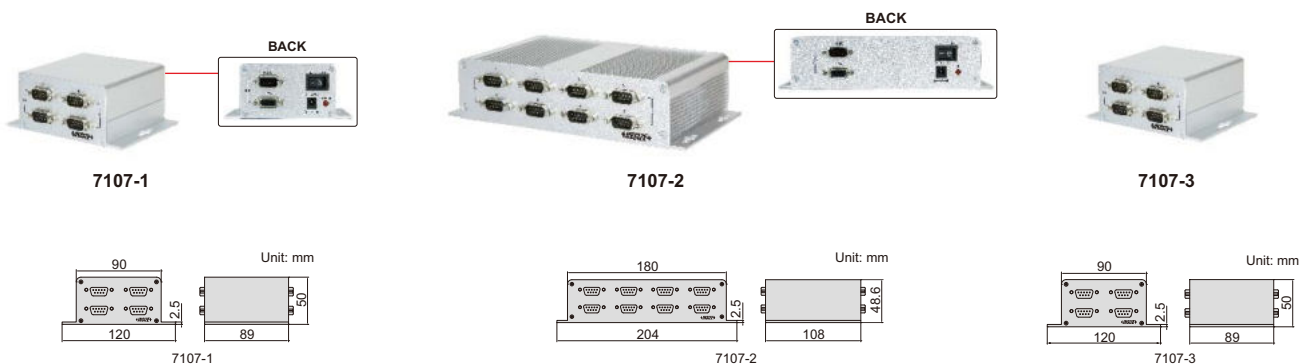

- Can be connected with **7107-11** or **7107-12** linear gages, can also be connected with digital indicators (data cable **7309-C01M** is needed)
- Connection box (code **7107-3**) is needed to connect interface boxes, when two or more interface boxes are used. Maximum 4 interface boxes can be connected.
- Software of interface boxes (included): in the software, it is possible to set tolerance of each channel and show judgment (red when out of tolerance, green when within tolerance), set zero, collect data manually or automatically (time is adjustable), output data to Excel, print report.

INTERFACE BOX SPECIFICATION

Code	7107-1	7107-2
Quantity of linear gages or digital indicators to be connected	4 pcs	8 pcs
Data output	RS232 and RS485	
Power supply	DC 9~24V	

CONNECTION BOX (OPTIONAL) SPECIFICATION

Code	7107-3
Quantity of interface boxes to be connected	4 pcs (maximum 4 interface boxes can be connected)
Data output	RS232 and RS485
Power supply	DC 9~24V

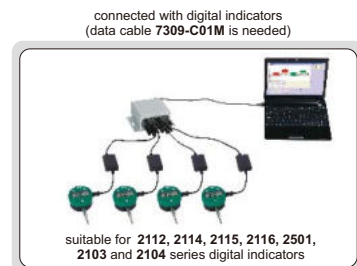
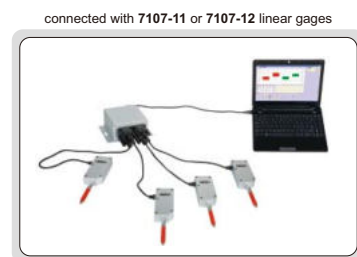
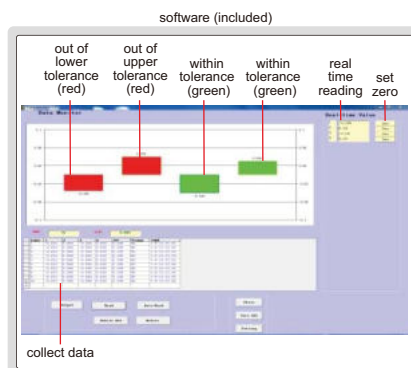

DIGITAL LINEAR GAGES



IP43
WATERPROOF

ABSOLUTE ENCODER, THE ORIGINAL DATA REMAINS AFTER POWER OFF

- Scale type: optical grating
- Absolute encoder, the original data remains after power off
- Digital signal output, amplifier is not required
- Repeatability: 0.5µm
- Measuring force: 1.5N
- Dust/waterproof: IP43
- Baud rate: 9600 (can be customized)
- Cable length: 3m (can be customized)



Code	Range	Resolution	Accuracy	Outgoing cable direction	Output signal	Output interface
7130-10	0-12.7mm	0.1µm	1.6µm	horizontal	RS232, TTL level	
7130-10L	0-12.7mm	0.1µm	1.6µm	vertical	RS232, TTL level	

PRECISION DIAL INDICATORS

INSPECTION CERTIFICATE

JEWELLED BEARING



2313-1A

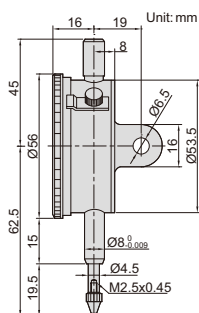

- Graduation: 0.001mm
- Dial reading: 0-100-0
- Jeweled bearing
- Supplied with limit pointers and bezel clamp
- Optional accessory: backs, contact points

Code	Range	Accuracy	Hysteresis	Range/rev	Remark
2313-1FA*	1mm	5µm	2µm	0.2mm	flat back
2313-2FA*	2mm	6µm	2.5µm	0.2mm	flat back
2313-1A*	1mm	5µm	2µm	0.2mm	lug back

*Supplied with manufacturer inspection certificate

DIAL INDICATORS (BASIC TYPE)

INSPECTION CERTIFICATE



2301-10

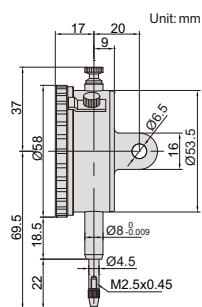

- Graduation: 0.01mm
- Dial reading: 0-100
- Meet DIN878
- Jeweled bearing
- Supplied with limit hands and bezel clamp
- Packed in carton box
- Optional accessory: backs, contact points



Code	Range	Accuracy	Hysteresis	Range/rev	Remark
2301-10F*	10mm	17µm	3µm	1mm	flat back
2301-10*	10mm	17µm	3µm	1mm	lug back with spare flat back

*Supplied with manufacturer inspection certificate

SHOCKPROOF DIAL INDICATORS

INSPECTION CERTIFICATE

- Graduation: 0.01mm
- Dial reading: 0-100
- Meet DIN878
- Shockproof
- Jeweled bearing
- Supplied with limit pointers and bezel clamp
- Optional accessory: backs, contact points

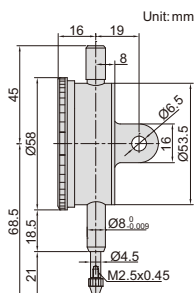

2314-10A

JEWELLED BEARING

SHOCK PROOF

Code	Range	Accuracy	Hysteresis	Range/rev	Remark
2314-10FA*	10mm	17µm	3µm	1mm	flat back
2314-10A*	10mm	17µm	3µm	1mm	lug back

*Supplied with manufacturer inspection certificate

COMPACT DIAL INDICATORS

INSPECTION CERTIFICATE

JEWELLED BEARING



2311-5

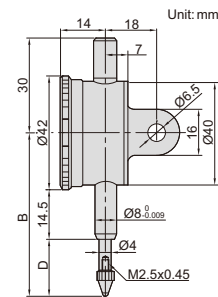

- Range/rev: 0.5mm
- Dial reading: 0-50
- Meet DIN878
- Jeweled bearing
- Supplied with limit pointers and bezel clamp
- Optional accessory: backs, contact points

Code	Range	Graduation	Accuracy	Hysteresis	Remark	B (mm)	D (mm)
2311-3F*	3mm	0.01mm	12µm	3µm	flat back	46	10.5
2311-5F*	5mm	0.01mm	14µm	3µm	flat back	48	12.5
2311-3*	3mm	0.01mm	12µm	3µm	lug back	46	10.5
2311-5*	5mm	0.01mm	14µm	3µm	lug back	48	12.5

*Supplied with manufacturer inspection certificate

DIAL INDICATORS (STANDARD TYPE)

INSPECTION CERTIFICATE

JEWELLED BEARING



2308-10A

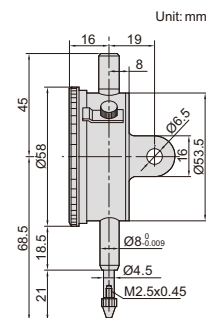

- Graduation: 0.01mm
- Dial reading: 0-100
- Meet DIN878
- Jeweled bearing
- Supplied with limit pointers and bezel clamp
- Optional accessory: backs, contact points

Code	Range	Accuracy	Hysteresis	Range/rev	Remark
2308-3FA*	3mm	12µm	3µm	1mm	flat back
2308-5FA*	5mm	14µm	3µm	1mm	flat back
2308-10FA*	10mm	17µm	3µm	1mm	flat back
2308-3A*	3mm	12µm	3µm	1mm	lug back
2308-5A*	5mm	14µm	3µm	1mm	lug back
2308-10A*	10mm	17µm	3µm	1mm	lug back

*Supplied with manufacturer inspection certificate

DOUBLE FACE DIAL INDICATOR



- Graduation: 0.01mm
- Meet DIN878
- Read from both sides
- Jeweled bearing
- Supplied with limit pointers
- Optional accessory: contact points



front

back

2328-10

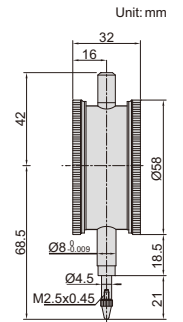

Code	Range	Accuracy	Hysteresis	Range/rev	Dial reading
2328-10*	10mm	17µm	3µm	1mm	0-100

*Supplied with manufacturer inspection certificate

WATERPROOF DIAL INDICATORS

IP54
WATERPROOF



2324-10A

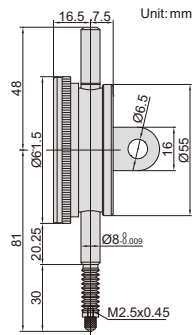

- Hysteresis: 3µm
- Dial reading: 0-100
- Meet DIN878
- IP54 dust/waterproof
- With limit pointers
- Optional accessory: back, contact points

Code	Range	Graduation	Accuracy	Range/rev	Remark
2324-10FA*	10mm	0.01mm	17µm	1mm	flat back
2324-10A*	10mm	0.01mm	17µm	1mm	lug back

*Supplied with manufacturer inspection certificate

DIAL INDICATOR (BASIC TYPE, LONG STROKE)



2302-25F

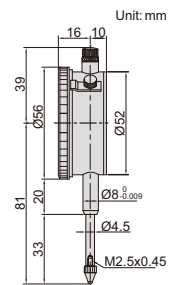

- Graduation: 0.01mm
- Dial reading: 0-100
- Supplied with limit pointers and bezel clamp
- Packed in carton box
- Optional accessory: backs, contact points



Code	Range	Accuracy	Hysteresis	Range/rev	Remark
2302-25F*	25mm	35µm	7µm	1mm	flat back

*Supplied with manufacturer inspection certificate

DIAL INDICATORS (LONG STROKE)



2310-30A

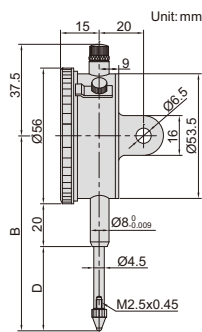

- Graduation: 0.01mm
- Dial reading: 0-100
- Supplied with limit pointers and bezel clamp
- Optional accessory: backs, contact points

Code	Range	Accuracy	Hysteresis	Range/rev	Remark	B	D
2310-20FA*	20mm	25µm	5µm	1mm	flat back	83	35
2310-30FA*	30mm	35µm	7µm	1mm	flat back	88	40
2310-20A*	20mm	25µm	5µm	1mm	lug back	83	35
2310-30A*	30mm	35µm	7µm	1mm	lug back	88	40

(mm)

*Supplied with manufacturer inspection certificate

ONE REVOLUTION DIAL INDICATORS



SHOCK PROOF



2316-05F

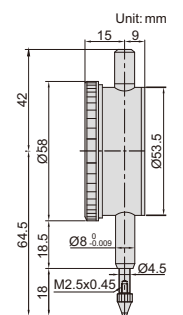

- Dial indicator stroke: 5mm
- Meet DIN878
- Eliminate the possibility of reading errors due to miscounting
- Shockproof
- With flat back
- Supplied with limit pointers
- Optional accessory: backs, contact points

Code	Range	Graduation	Accuracy	Hysteresis	Dial reading
2316-05F*	0.5mm	0.01mm	9µm	3µm	25-0-25
2316-1F*	1mm	0.01mm	9µm	3µm	50-0-50

*Supplied with manufacturer inspection certificate

DIAL INDICATORS (LONG STROKE)

JEWELLED BEARING

SHOCK PROOF

INSPECTION CERTIFICATE

- Range/rev: 1mm
- Dial reading: 0-100
- Shockproof
- Jeweled bearing
- Supplied with limit pointers
- Optional accessory: backs, contact points



2309-50

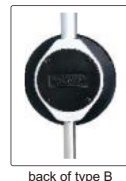

back of type B



stem clamp Ø10mm of 2309-100D

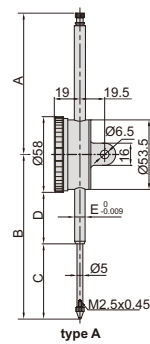

type A

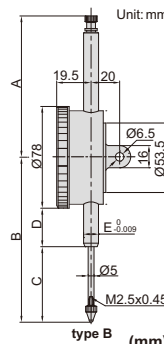

type B (mm)

Code	Range	Type	Graduation	Accuracy	Hysteresis	Remark
2309-30F *	30mm	A	0.01mm	35µm	7µm	flat back
2309-50 *	50mm	A	0.01mm	40µm	8µm	flat back with spare lug back
2309-50D *	50mm	B	0.01mm	40µm	8µm	flat back with spare lug back
2309-100D	100mm	B	0.01mm	50µm	9µm	flat back with spare lug back

Code	Type	A	B	C	D	E
2309-30F	A	37.5	89.5	40.9	19.5	Ø8
2309-50	A	108.3	126.2	57.7	39.5	Ø8
2309-50D	B	108.3	126.2	57.7	29.5	Ø8
2309-100D	B	167.6	207.8	108	60.8	Ø10

Note: 1) 2309-100D can only be used vertically
 2) 2309-100D is supplied with stem clamp Ø10mm for magnetic stands (code 6200-60, 6201-60, 6202-80, 6202-100)
 3) 2309-30F can not accept optional backs

* Supplied with manufacturer inspection certificate

CONTACT POINTS

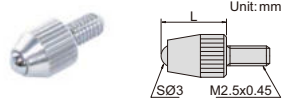

6282-0101

BALL POINT

Code	Material of measuring face	L (mm)
6282-0101	carbide	7.3
6282-0103	ceramic	7.3
6282-0104	carbide	8.3

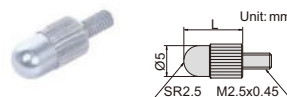

6282-0205

SHELL TYPE POINT

Code	Material of measuring face	L
6282-0205	steel	15mm
6282-0210	steel	30mm

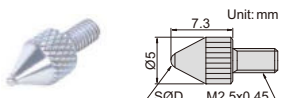

6282-0301

BALL POINT

Code	Material of measuring face	SØD
6282-0301	steel	1mm
6282-0302	carbide	1.5mm
6282-0303	carbide	1.8mm
6282-0304	carbide	2.5mm
6282-0305	carbide	4mm

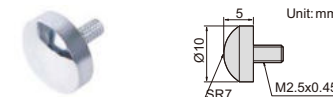

6282-0401

SPHERICAL POINT

Code	Material of measuring face
6282-0401	steel



6282-1101

FLAT POINT

Code	Material of measuring face	L
6282-1101	steel	8mm

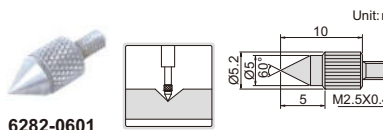

6282-0601

CONICAL POINT

Code	Material of measuring face
6282-0601	steel



6282-1601

NEEDLE POINT (mm)

Code	Material of measuring face	L1	L	SR	Ød
6282-1601	steel	11	15	0.4	2
6282-1602	steel	13	17	0.2	2
6282-1603	steel	21	25	0.4	3
6282-1604	steel	31	35	0.4	3

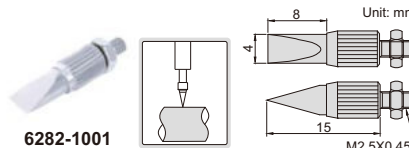
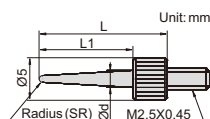

6282-1001

KNIFE EDGE POINT

Code	Material of measuring face
6282-1001	steel

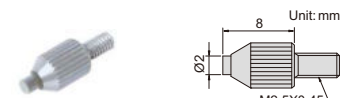

6282-1301

FLAT POINT

Code	Material of measuring face
6282-1301	carbide



6282-1706

NEEDLE POINT

Code	Material of measuring face	ØD	L
6282-1705	carbide	1mm	8mm
6282-1706	carbide	1mm	10mm
6282-1707	carbide	1mm	20mm
6282-1708	carbide	1mm	40mm
6282-1712	carbide	1.5mm	20mm
6282-1713	carbide	1.5mm	40mm
6282-1714	carbide	2mm	8mm
6282-1715	carbide	2mm	18mm
6282-1716	carbide	2mm	28mm
6282-1717	carbide	2mm	40mm

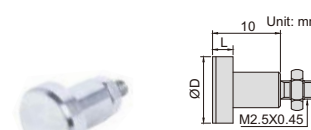
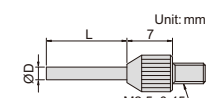

6282-1201

FLAT POINT (mm)

Code	Material of measuring face	ØD	L
6282-1201	steel	10	3
6282-1202	steel	15	4
6282-1203	steel	20	3
6282-1204	steel	25	4
6282-1205	steel	30	4

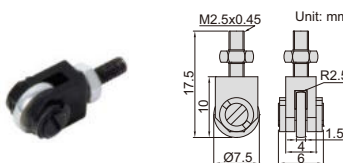

6282-1901

ROLLER POINT

Code	Material of measuring face
6282-1901	steel

EXTENSION RODS

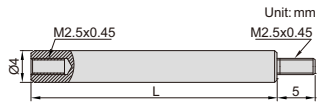

6282-2011

Code	Material	L
6282-2001	steel	10mm
6282-2002	steel	15mm
6282-2003	steel	20mm
6282-2004	steel	25mm
6282-2005	steel	30mm
6282-2006	steel	35mm
6282-2007	steel	40mm
6282-2008	steel	45mm
6282-2009	steel	50mm

Code	Material	L
6282-2010	steel	55mm
6282-2011	steel	60mm
6282-2012	steel	65mm
6282-2013	steel	70mm
6282-2014	steel	75mm
6282-2015	steel	80mm
6282-2016	steel	90mm
6282-2017	steel	100mm

SPINDLE LIFT KNOB



7332



- For dial/digital indicators with spindle diameter Ø4.5mm or Ø5mm

Code
7332

MAGNETIC BACKS



front



back

7331-M2



(mm)

Code	ØD	For digital/dial indicators
7331-M1	51.5	2103
		2104
		2108
		2109
		2112
		2115
		2116
		2117
		2118
		2138
		2301
		2302
		2308
		2309 (except 2309-30, 2309-30F)
		2313
		2314
		2316
2801		
2318		
7331-M2	54	

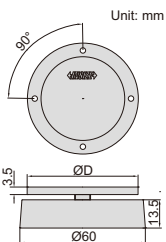

LUG BACKS



7330-L2

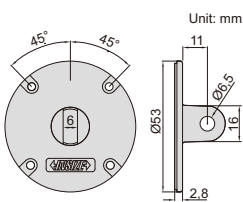

7330-L2 and 7330-L10

Code	For digital/dial indicators
7330-L1	2311
7330-L2	2308
	2309 (except 2309-30, 2309-30F)
	2313
	2314
	2324
	2316
7330-L5	2103
	2104
	2108
	2109
	2112
	2113
2115	
7330-L10	2310

DIAL TEST INDICATORS



JEWELLED BEARING



2380-08

clamps (included)

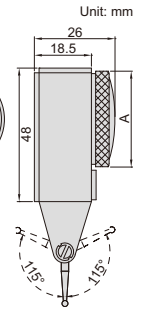
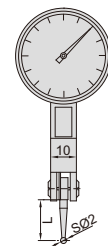
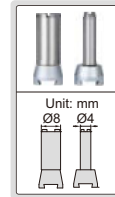

- Meet DIN2270 (except 2380-02, 2381-02)
- Jeweled bearing
- Carbide contact point
- Two measuring directions
- Anti magnetic body
- Supplied with two clamps: diameter Ø4mm and Ø8mm
- Optional accessory: styli

Graduation: 0.01mm

Code	Range	Accuracy	Hysteresis	Dial reading	A	L
2380-08*	0.8mm	13µm	3µm	0-40-0	Ø30	13.5
2381-08*	0.8mm	13µm	3µm	0-40-0	Ø37	13.5

Graduation: 0.002mm

Code	Range	Accuracy	Hysteresis	Dial reading	A	L
2380-02*	0.2mm	6µm	2µm	0-100-0	Ø30	12.5
2381-02*	0.2mm	6µm	2µm	0-100-0	Ø37	12.5

Graduation: 0.001mm

Code	Range	Accuracy	Hysteresis	Dial reading	A	L
2381-021*	0.2mm	6µm	2µm	0-100-0	Ø37	12.5

*Supplied with manufacturer inspection certificate

TILTED FACE TYPE DIAL TEST INDICATOR



JEWELLED BEARING



2399-08

clamps (included)

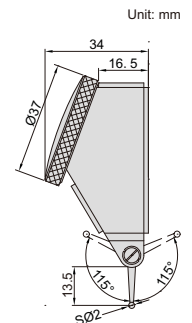
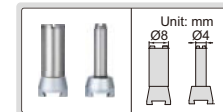

- Meet DIN2270
- Jeweled bearing
- Carbide contact point
- Two measuring directions
- Anti magnetic body
- Supplied with two clamps: diameter Ø4mm and Ø8mm
- Optional accessory: styli

Code	Range	Graduation	Accuracy	Hysteresis	Dial reading
2399-08*	0.8mm	0.01mm	13µm	3µm	0-40-0

*Supplied with manufacturer inspection certificate

VERTICAL TYPE DIAL TEST INDICATOR



- Meet DIN2270
- Jeweled bearing
- Carbide contact point
- Two measuring directions
- Anti magnetic body
- Supplied with two clamps: diameter Ø4mm and Ø8mm
- Optional accessory: styli

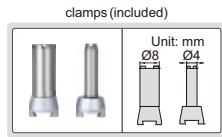

Code	Range	Graduation	Accuracy	Hysteresis	Dial reading
2398-08*	0.8mm	0.01mm	13µm	3µm	0-40-0

*Supplied with manufacturer inspection certificate

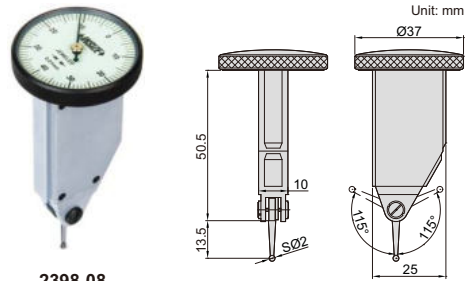

2398-08

JEWELLED BEARING

LONG STYLI DIAL TEST INDICATOR



JEWELLED BEARING



2383-08A

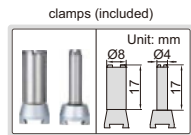

- Meet DIN2270
- Jeweled bearing
- Carbide contact point
- Two measuring directions
- Anti magnetic body
- Supplied with two clamps: diameter Ø4mm and Ø8mm
- Optional accessory: styli

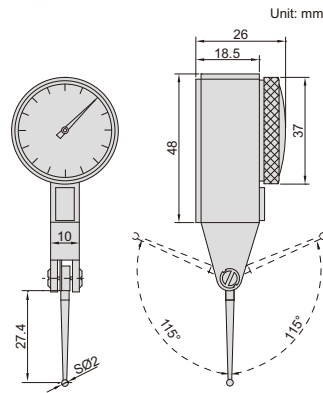

Code	Range	Graduation	Accuracy	Hysteresis	Dial reading
2383-08A*	0.8mm	0.01mm	13µm	3µm	0-40-0

*Supplied with manufacturer inspection certificate

LARGE RANGE DIAL TEST INDICATOR



JEWELLED BEARING



2386-16A

- Jeweled bearing
- Carbide contact point
- Two measuring directions
- Anti magnetic body
- Supplied with two clamps: diameter Ø4mm and Ø8mm
- Optional accessory: styli

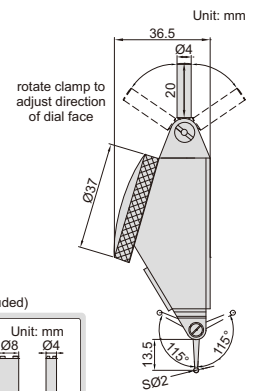
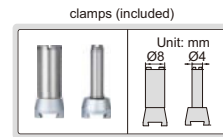

Code	Range	Graduation	Accuracy	Hysteresis	Dial reading
2386-16A*	1.6mm	0.01mm	25µm	8µm	0-40-0

*Supplied with manufacturer inspection certificate

LARGE RANGE BACK PLUNGER TYPE DIAL TEST INDICATOR

JEWELLED BEARING



- Jeweled bearing
- Carbide contact point
- Two measuring directions
- Anti magnetic body
- Supplied with two clamps: diameter Ø4mm and Ø8mm
- Optional accessory: styli

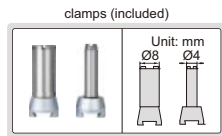

Code	Range	Graduation	Accuracy	Hysteresis	Dial reading
2480-16*	1.6mm	0.01mm	18µm	3µm	0-40-0

*Supplied with manufacturer inspection certificate



2480-16

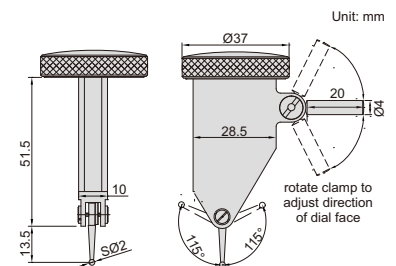

CLAMPS FOR DIAL TEST INDICATORS

Code	ØD
6298-1	Ø4mm
6298-2	Ø8mm



6298-1



6298-2

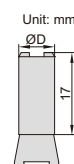

STYLI FOR DIAL TEST INDICATORS

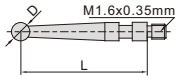

6284-3

(mm)				
Code	For dial test indicator	Material of contact point	L	D
6284-1	2380-08	steel	13.5	SØ1
6284-3		carbide	13.5	SØ2
6284-4	2381-08	ruby	13.5	SØ2
6284-8	2399-08	carbide	13.5	SØ3
6284-21	2380-02	steel	12.5	SØ1
6284-22	2381-02	carbide	12.5	SØ2

DIAL TEST INDICATOR UNIVERSAL HOLDER

- Set the indicators at the desired attitude to the workpiece



6297-1

Code
6297-1

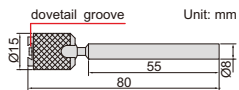

DIAL TEST INDICATOR HOLDER



6296-1

- Supplied with hex key

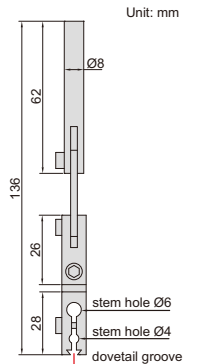

Code
6296-1

DIAL TEST INDICATOR HOLDERS



6293-1

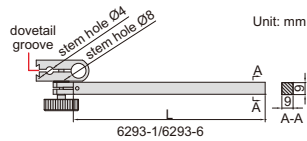

6293-2

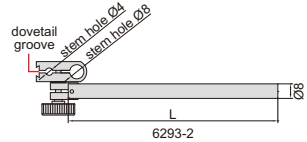

Code	Stem section	Stem length (L)
6293-1	9x9mm	100mm
6293-6	9x9mm	50mm
6293-2	Ø8mm	115mm



DIAL TEST INDICATOR HOLDER



6291-1

- Can be used with dial test indicators

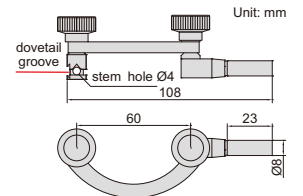

Code
6291-1

DIAL TEST INDICATOR HOLDER

- Can be used with dial test indicators

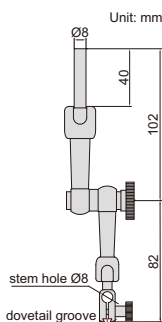

6295-1A

Code
6295-1A

DIAL INDICATOR HOLDER

- Can be used with dial test indicators or dial indicators

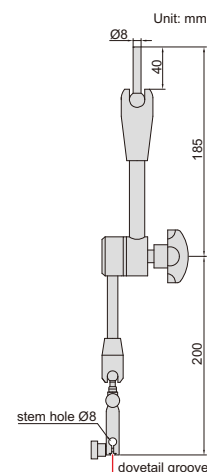

6294-1A

Code
6294-1A

DIAL INDICATOR TESTER CODE 2396-25A

- To calibrate dial indicators, test indicators and dial bore gages
- Dimension: 270x210x205mm
- Weight: 11kg

Micrometer head

Range	Sampling interval	Accuracy	Hysteresis
0-25mm	0.1mm	4µm (0-25mm), 3µm (0-10mm), 2µm (0-1mm)	1µm

Force gage

Range	Graduation	Accuracy
0-1.6N	0.05N	±5% (of load capacity)

Platform

Diameter	Flatness	Roughness
50mm	1µm	0.05µm



Half round gage block (optional)

Code	Parallelism
2396-block	1µm

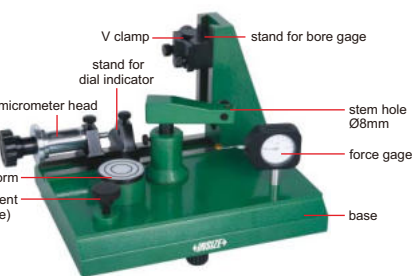

2396-25A

ATTENTION: NOT SUITABLE FOR
INDICATORS WITH GRADUATION 0.001MM



UNIVERSAL MAGNETIC STAND (ECONOMIC TYPE)

ATTENTION: LOW
LOCKING FORCE

- Applicable holding stem: Ø8mm
- For digital/dial indicators and dial test indicators

6208-80A

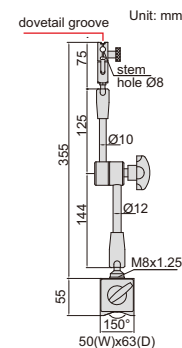

Code	Magnetic force	Remark
6208-80A	80kgf	with fine adjustment and dovetail groove

UNIVERSAL MAGNETIC STANDS

- For digital/dial indicators and dial test indicators
- With fine adjustment and dovetail groove

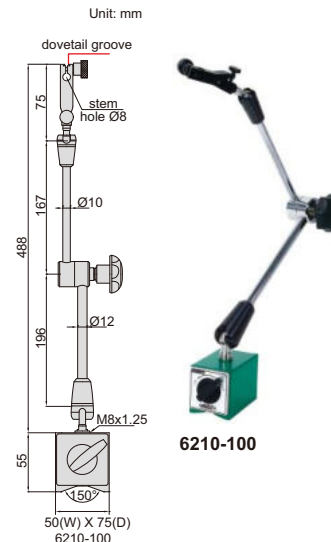
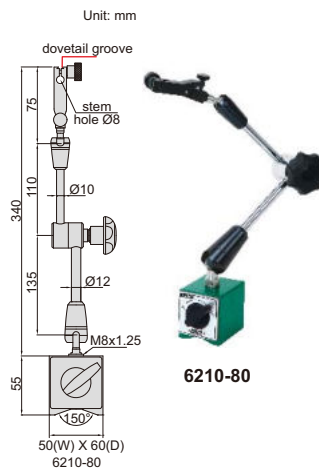
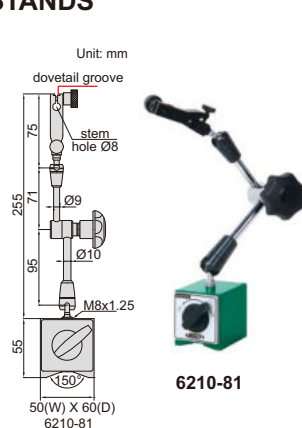

Code	Magnetic force	Applicable holding stem
6210-81	80kgf	Ø8mm
6210-80	80kgf	Ø8mm
6210-100	100kgf	Ø8mm

MAGNETIC STANDS

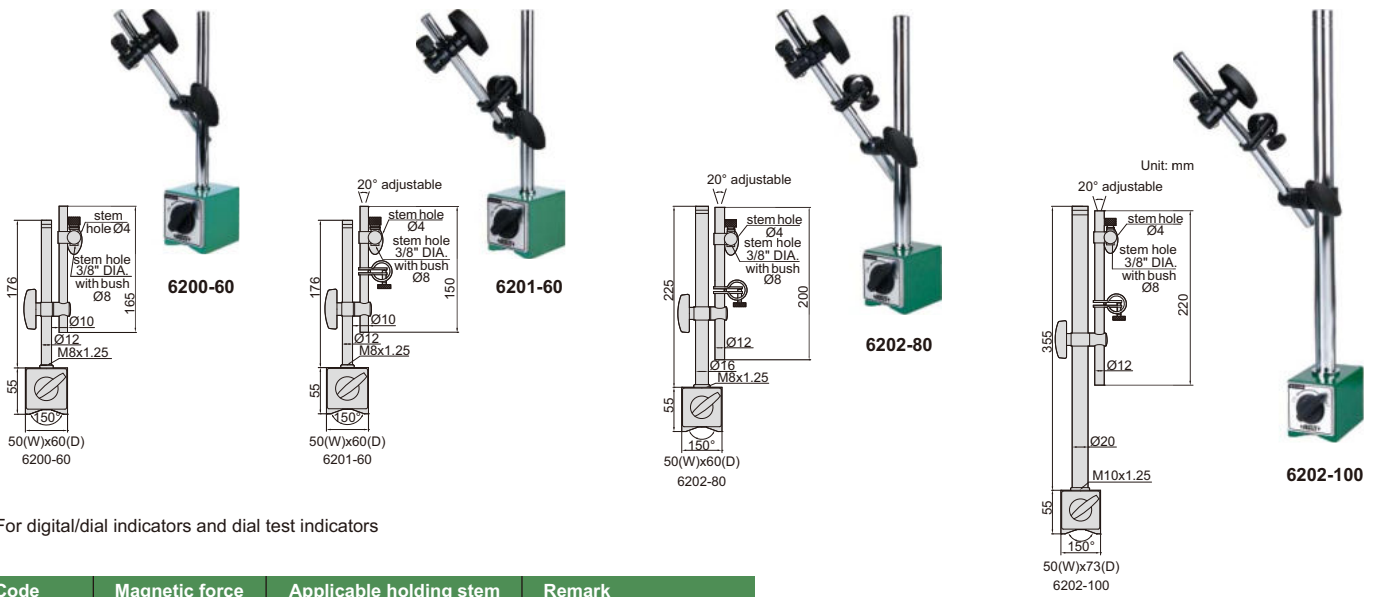

- For digital/dial indicators and dial test indicators

Code	Magnetic force	Applicable holding stem	Remark
6200-60	60kgf	Ø8mm, Ø4mm, 3/8" DIA.	without fine adjustment
6201-60	60kgf	Ø8mm, Ø4mm, 3/8" DIA.	with fine adjustment
6202-80	80kgf	Ø8mm, Ø4mm, 3/8" DIA.	with fine adjustment
6202-100	100kgf	Ø8mm, Ø4mm, 3/8" DIA.	with fine adjustment

HYDRAULIC UNIVERSAL MAGNETIC STANDS

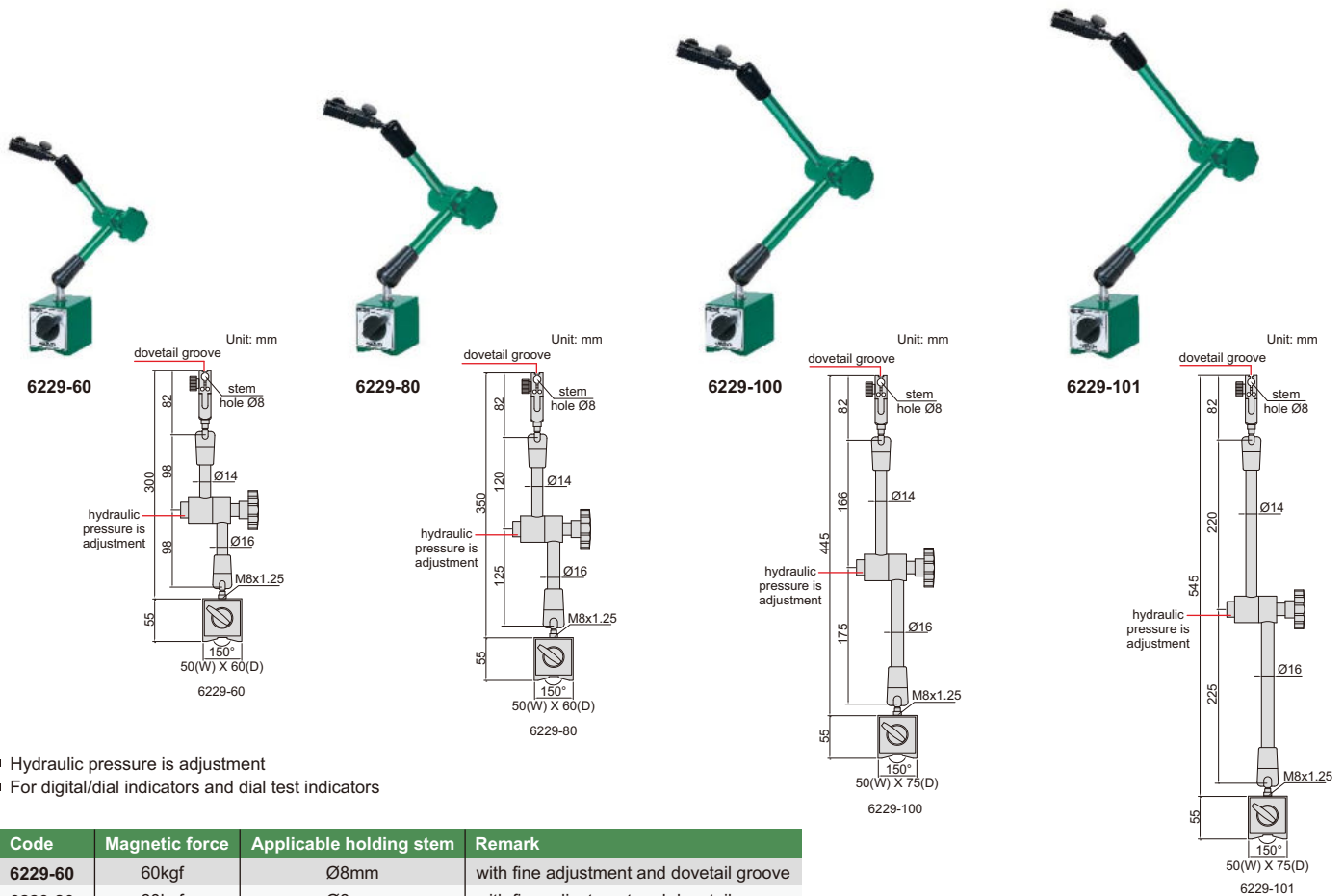

- Hydraulic pressure is adjustment
- For digital/dial indicators and dial test indicators

Code	Magnetic force	Applicable holding stem	Remark
6229-60	60kgf	Ø8mm	with fine adjustment and dovetail groove
6229-80	80kgf	Ø8mm	with fine adjustment and dovetail groove
6229-100	100kgf	Ø8mm	with fine adjustment and dovetail groove
6229-101	100kgf	Ø8mm	with fine adjustment and dovetail groove

MAGNETIC STAND WITH DOUBLE FINE ADJUSTMENT

- Magnetic force: 80kgf
- With double fine adjustments on the head and on the base
- For digital/dial indicators and dial test indicators

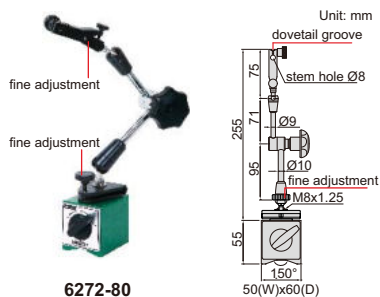

6272-80

Code	Applicable holding stem	Remark
6272-80	Ø8mm	with double fine adjustment and dovetail groove

MAGNETIC STAND

- For digital/dial indicators and dial test indicators



6216-80

Code	Magnetic force	Applicable holding stem	Remark
6216-80	80kgf	Ø8mm	with fine adjustment and dovetail groove

MAGNETIC STAND (FOR 0.001MM DIAL AND DIAL TEST INDICATORS)

- For 0.001mm and 0.01mm dial and dial test indicators

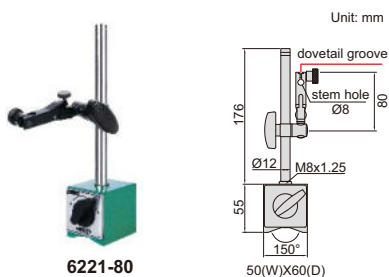

6221-80

Code	Magnetic force	Applicable holding stem	Remark
6221-80	80kgf	Ø8mm	with fine adjustment and dovetail groove

FLEX ARM MAGNETIC STAND

ATTENTION: FOR DIAL TEST INDICATORS ONLY

- For dial test indicators

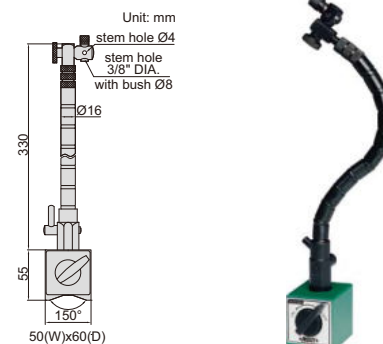

6207-80A

Code	Magnetic force	Applicable holding stem
6207-80A	80kgf	Ø8mm, Ø4mm, 3/8" DIA.

HYDRAULIC MINI MAGNETIC STAND

ATTENTION: FOR DIAL TEST INDICATORS ONLY

- For dial test indicators
- With fine adjustment and dovetail groove
- Adjustable hydraulic force

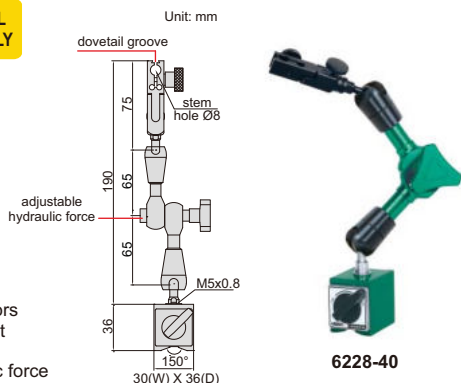

6228-40

Code	Magnetic force	Applicable holding stem
6228-40	40kgf	Ø8mm

MINI MAGNETIC STAND

ATTENTION: FOR DIAL TEST INDICATORS ONLY

- For dial test indicators
- With fine adjustment and dovetail groove

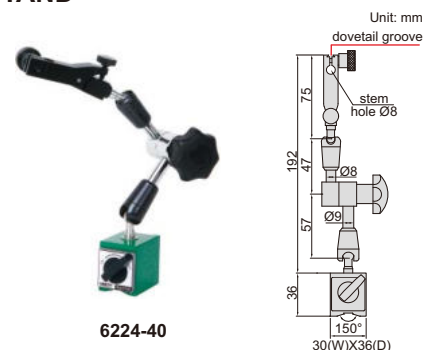

6224-40

Code	Magnetic force	Applicable holding stem
6224-40	40kgf	Ø8mm

MINI MAGNETIC STAND

- For dial test indicators
- With dovetail groove

6211-10

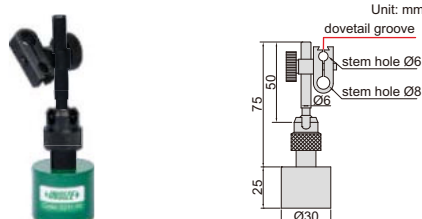

ATTENTION: FOR DIAL TEST INDICATORS ONLY

Code	Magnetic force	Applicable holding stem
6211-10	10kgf	Ø6mm, Ø8mm

VACUUM STAND

- Diameter of vacuum disc: Ø80mm
- Suitable for granite surface plates or cast iron surface plates
- For digital/dial indicators and dial test indicators



6217-B

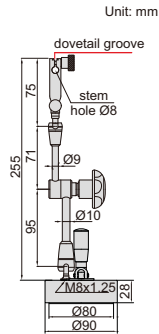

Code	Vacuum force	Applicable holding stem	Remark
6217-B	80kgf	Ø8mm	with fine adjustment and dovetail groove

UNIVERSAL STAND

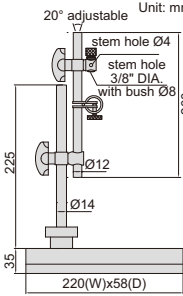

6214-A

- For digital/dial indicators and dial test indicators
- With fine adjustment

Code	Applicable holding stem
6214-A	Ø8mm, Ø4mm, 3/8" DIA.

UNIVERSAL DIAL INDICATOR STANDS (NON-MAGNETIC)

- Hardened base
- Suitable for granite surface plates and cast iron surface plates
- For digital/dial indicators and dial test indicators



6225-80

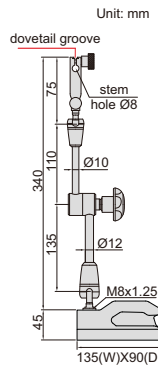

6225-100

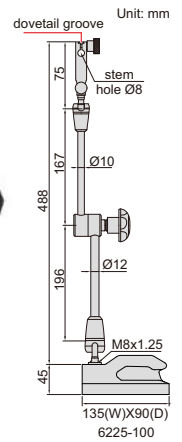

Code	Applicable holding stem	Remark
6225-80	Ø8mm	with fine adjustment and dovetail groove
6225-100	Ø8mm	with fine adjustment and dovetail groove

DIAL INDICATOR STANDS (NON-MAGNETIC)



6226-60

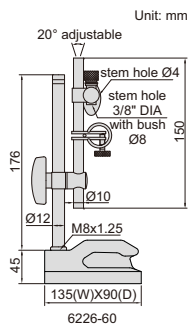

6226-80

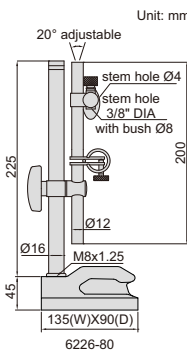

6226-100

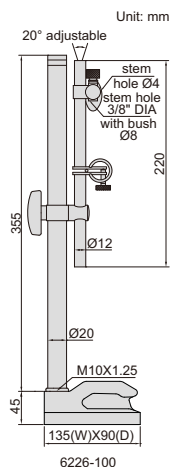

Code	Applicable holding stem	Remark
6226-60	Ø8mm, Ø4mm, 3/8" DIA	with fine adjustment
6226-80	Ø8mm, Ø4mm, 3/8" DIA	with fine adjustment
6226-100	Ø8mm, Ø4mm, 3/8" DIA	with fine adjustment

- Hardened base
- Suitable for granite surface plates and cast iron surface plates
- For digital/dial indicators and dial test indicators

DIAL INDICATOR STAND (NON-MAGNETIC)

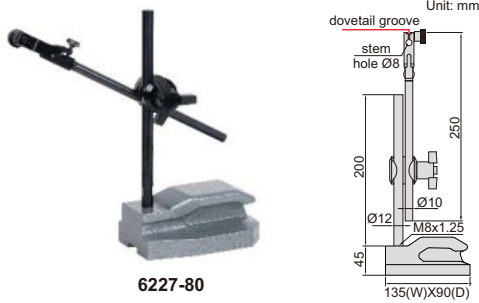

6227-80

- Hardened base
- Suitable for granite surface plates and cast iron surface plates
- For digital/dial indicators and dial test indicators

Code	Applicable holding stem	Remark
6227-80	Ø8mm	with fine adjustment and dovetail groove

DIAL INDICATOR STAND (FOR 0.001MM DIAL AND DIAL TEST INDICATORS)

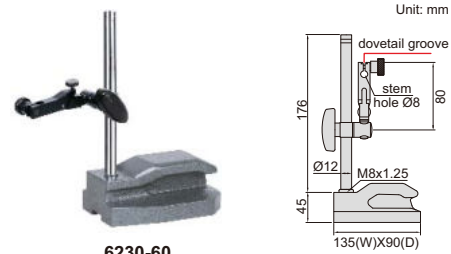

6230-60

- Non-magnetic and hardened base
- Suitable for granite surface plates or cast iron surface plates
- For 0.001mm and 0.01mm dial and dial test indicators

Code	Applicable holding stem	Remark
6230-60	Ø8mm	with fine adjustment and dovetail groove

DIAL INDICATOR STANDS

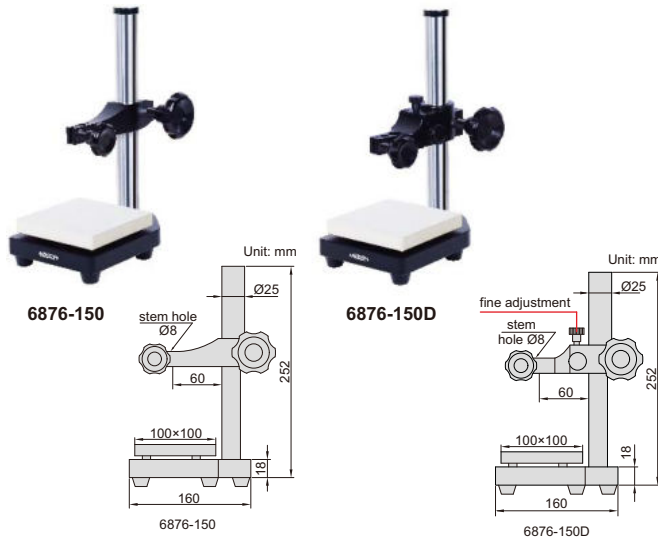

6876-150

6876-150D

- Vertical travel of holder: 150mm
- Applicable holding stem: Ø8mm
- Ceramic anvil
- Supplied with dust cover

Code	Anvil	Remark
6876-150	ceramic, plain, flatness 1.5µm	without fine adjustment
6876-150D	ceramic, plain, flatness 1.5µm	with fine adjustment, fine adjustment range 3mm

GRANITE DIAL INDICATOR STANDS (BASIC TYPE)

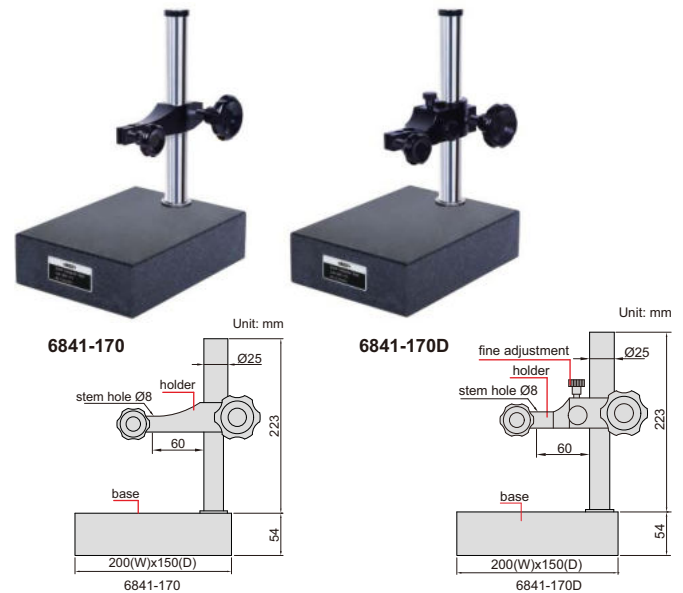

6841-170

6841-170D

- Vertical travel of holder: 170mm
- Applicable holding stem: Ø8mm
- Supplied with dust cover

Code	Anvil	Remark
6841-170	flatness 1.5µm	without fine adjustment
6841-170D	flatness 1.5µm	with fine adjustment, fine adjustment range 3mm

GRANITE DIAL INDICATOR STAND

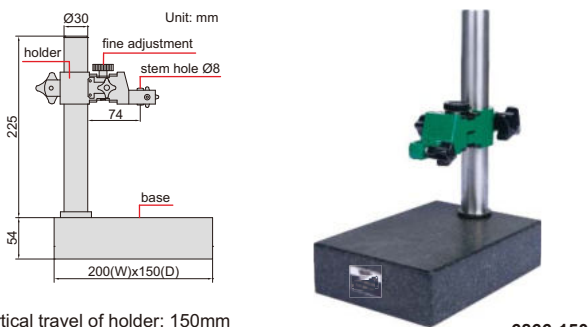

6866-150

- Vertical travel of holder: 150mm
- Fine adjustment range: 2mm
- Supplied with dust cover

Code	Applicable holding stem	Base
6866-150	Ø8mm	flatness 2.5µm

GRANITE DIAL INDICATOR STANDS

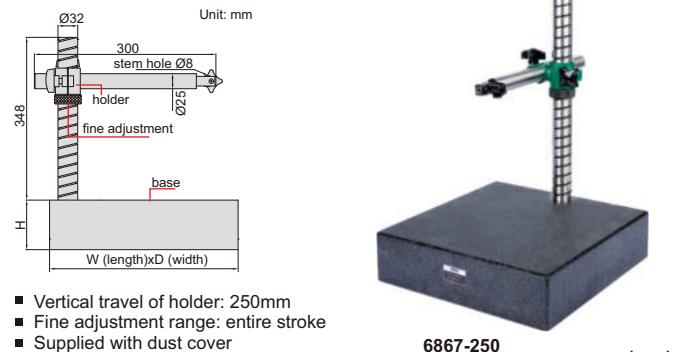

6867-250

- Vertical travel of holder: 250mm
- Fine adjustment range: entire stroke
- Supplied with dust cover

Code	Applicable holding stem	W	D	H	Base
6867-250	Ø8mm	300	300	75	flatness 2.8µm
6867-400	Ø8mm	400	300	100	flatness 3µm

DIAL INDICATOR STANDS

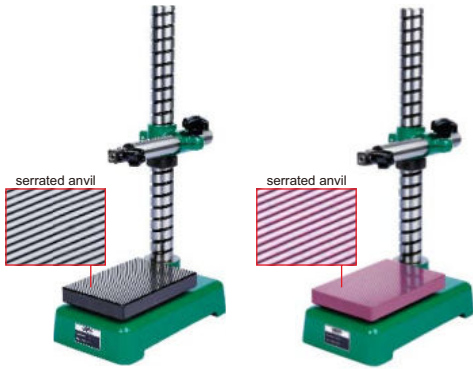

6864-250

6864-250T

Unit: mm

- Vertical travel of holder: 250mm
- Applicable holding stem: Ø8mm
- Fine adjustment range: entire stroke
- Supplied with dust cover

Code	Anvil
6864-250	steel (hardness HRC60±2), serrated, flatness 1.5µm
6864-250T	ceramic, serrated, flatness 1.5µm

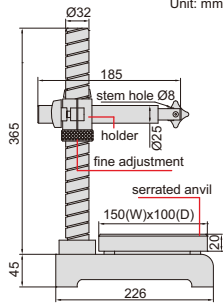

DIAL INDICATOR STANDS

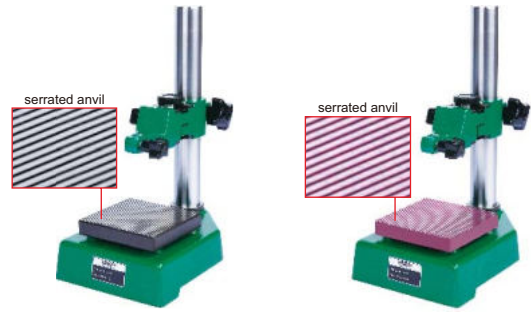

6863-150

6863-150T

Unit: mm

- Vertical travel of holder: 150mm
- Fine adjustment range: 2mm
- Applicable holding stem: Ø8mm
- Supplied with dust cover

Code	Anvil
6863-150	steel (hardness HRC60±2), serrated, flatness 1.5µm
6863-150T	ceramic, serrated, flatness 1.5µm

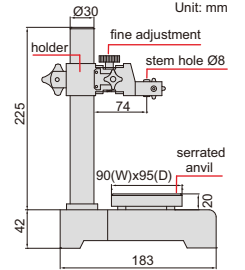

DIAL INDICATOR STANDS



6862-1001

6862-1002

Unit: mm

Code	Anvil
6862-1001	steel (hardness HRC60±2), serrated, flatness 1.5µm
6862-1002	steel (hardness HRC60±2), plain, flatness 1.5µm
6862-1001T	ceramic, serrated, flatness 1.5µm
6862-1002T	ceramic, plain, flatness 1.5µm

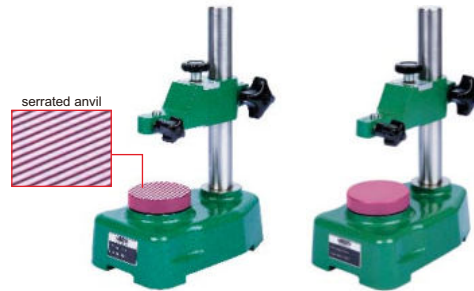
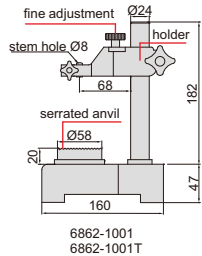

6862-1001T

6862-1002T

Unit: mm

- Vertical travel of holder: 100mm
- Fine adjustment range: 2mm
- Applicable holding stem: Ø8mm
- Supplied with dust cover

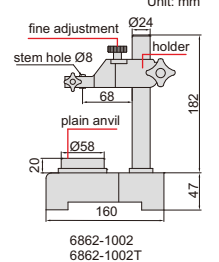

HEAVY DUTY DIAL INDICATOR STAND

- Vertical travel of holder: 300mm
- Fine adjustment range: 5mm
- Carbide base
- Supplied with dust cover
- Optional accessory: holder with stem hole Ø28 (code 6869-D28)

Code	Applicable holding stem	Base
6869-300	Ø8mm	plain, flatness 1µm, carbide



6869-300

Unit: mm

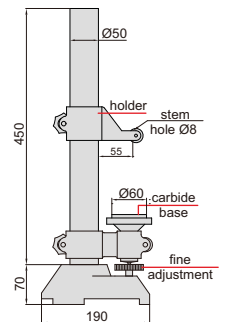

TRANSFER STANDS

- Vertical travel of holder: 335mm
- Fine adjustment range: 2mm
- Applicable holding stem: Ø8mm
- Supplied with dust cover

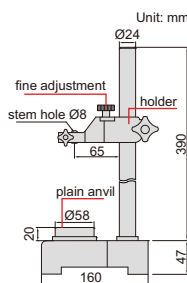

rigid construction, designed to make comparison height measurement (set zero with gage block then measure height of workpiece) with dial indicators or digital indicators (variation of measuring force is high)

Code	Anvil
6865-300	steel (hardness HRC60±2), plain, flatness 1.5µm
6865-300T	ceramic, plain, flatness 1.5µm

DIGITAL RUBBER THICKNESS GAGES

DATA OUTPUT



2878-6B

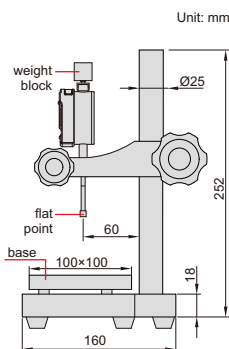

2878-71B

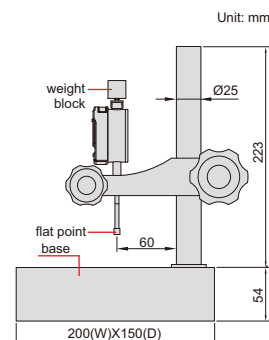

- Measure thickness of vulcanized rubber and plastic products
- Button function: on/off, inch/mm, zero, data preset, change measuring direction, absolute/incremental measurement
- CR2032 battery, automatic power off (time is adjustable)
- Supplied with dust cover
- Optional accessory: data output cable (code 7315-50M, 7302-50M), flat points, weight blocks

Code	Range	Resolution	Accuracy	Flat point diameter	Pressure	Base
2878-6A	12.7mm/0.5"	0.01mm/0.0005"	20µm	6mm	22kPa±5kPa	ceramic, plain, flatness 1.5µm
2878-6B	12.7mm/0.5"	0.001mm/0.00005"	5µm	6mm	22kPa±5kPa	ceramic, plain, flatness 1.5µm
2878-71A	12.7mm/0.5"	0.01mm/0.0005"	20µm	6mm	22kPa±5kPa	granite, plain, flatness 2.5µm
2878-71B	12.7mm/0.5"	0.001mm/0.00005"	5µm	6mm	22kPa±5kPa	granite, plain, flatness 2.5µm

Flat points and weight blocks (Optional)

Flat point	Flat point code	Pressure				
		10kPa±2kPa	22kPa±5kPa	20kPa±3kPa	70kPa±5kPa	1.6kPa±0.1kPa
		Weight block code	Weight block code	Weight block code	Weight block code	Weight block code
Ø4mm	2878-P4	—	2878-W4B	—	—	—
Ø5mm	2878-P5	2878-W5A	2878-W5B	2878-W5C	2878-W5D	—
Ø6mm	2878-P6	2878-W6A	2878-W6B	—	—	—
Ø8mm	2878-P8	2878-W8A	2878-W8B	—	—	—
Ø10mm	2878-P10	2878-W10A	2878-W10B	2878-W10C	—	—
Ø25mm	2878-P25	—	—	—	—	2878-W25E
1x4mm (rectangle)	2878-P14	—	—	—	2878-W14D	—

CONCENTRICITY GAGES

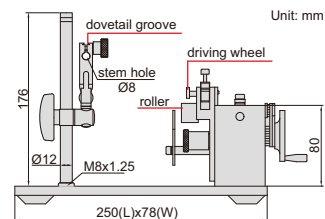
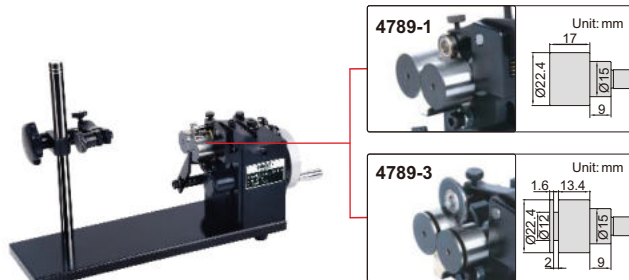
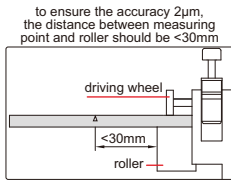

- Optional accessory: dial test indicator

Code	Accuracy	Applicable diameter
4789-1	2µm	Ø3.5mm-25mm
4789-3	2µm	Ø1mm-25mm

CONCENTRICITY GAGES

HIGH STABILITY,
LONG WORKING LIFE

dial test indicator is optional

dial test indicator is optional

dial test indicator is optional



4725-45



4725-60



4725-80



- With ball bearing, high stability, long working life
- Accuracy: 2µm
- Optional accessory: dial test indicator

Code	Diameter range	Center height (h)	LxWxH	Weight
4725-45	3-45mm	80mm	280x130x170mm	6kg
4725-60	8-60mm	90mm	350x160x190mm	15.6kg
4725-80	8-80mm	130mm	400x200x250mm	25kg

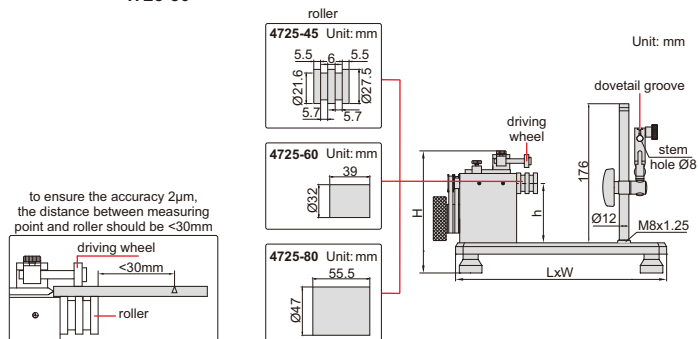

CONCENTRICITY GAGE

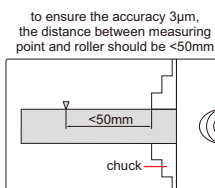

4786-1

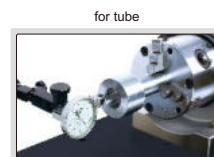
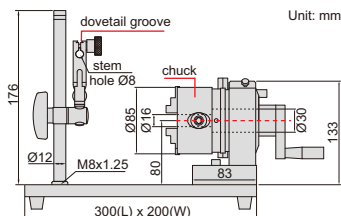

- Accuracy: 3µm
- Ø50mm setting ring and Ø55mm calibration cylinder are included
- Optional accessory: dial test indicator

Code	Applicable inside diameter	Applicable outside diameter
4786-1	Ø24-64mm	Ø2-70mm

MINI BENCH CENTER

- Distance between two centers (D): 35-100mm
- Diameter of center (Ød): 6mm
- Taper of center: MT1

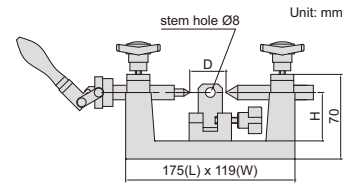

4721-75A

Code	Runout accuracy	Center height (H)	Weight	Load
4721-75A	2µm	40mm	4.5kg	4kg

BENCH CENTER (BASIC TYPE)

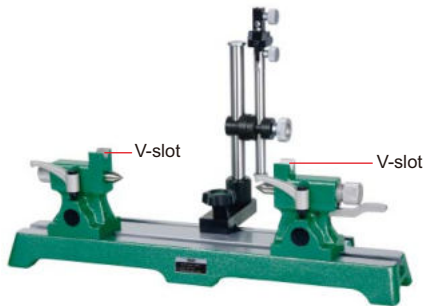

4782-300

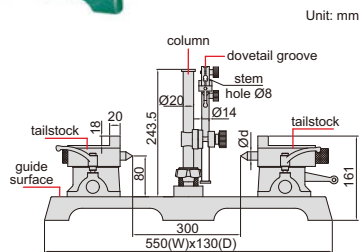

- Runout accuracy: 2µm
- Distance between two centers: 300mm
- Taper of center: MT1
- Hardened cast-iron guide surface
- Movable column
- V-slot for cylinder Ø4~Ø22mm

Code	Parallelism*	Center height	Diameter of center (Ød)	Load
4782-300	0.01mm	80mm	Ø16mm	25kg

*Parallelism of two centers to the guide surface

VERTICAL BENCH CENTER

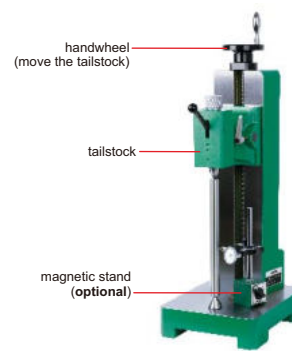

4728-360

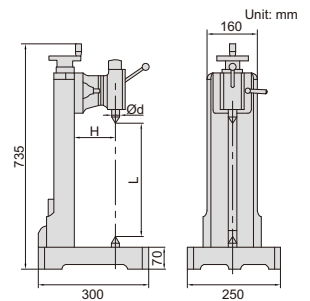

- Runout accuracy: 2µm
- Distance between two centers (L): 360mm
- Diameter of center (Ød): 24.1mm
- Taper of center: MT3
- Hardened cast-iron guide surface
- Use handwheel to move the tailstock
- Optional accessory: magnetic stands, dial test indicators

Code	Parallelism*	Center height (H)	Weight	Load
4728-360	0.01mm	130mm	85kg	80kg

*Parallelism of two centers to the guide surface

SHANK RUNOUT TESTERS

standard shank (included)



4771-30

- Measure the radial runout of shanks, collets and cutting tools
- Optional accessory: dial test indicators, magnetic stands

Code	Taper	Accuracy
4771-30	BT30	1µm
4771-40	BT40	1µm
4771-50	BT50	1µm

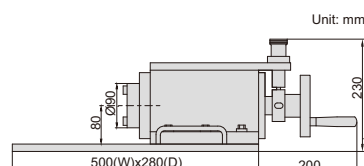

measure radial runout of shank

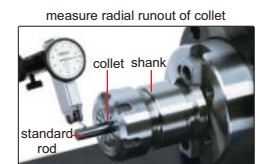

measure radial runout of collet

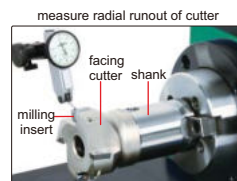

measure radial runout of cutter

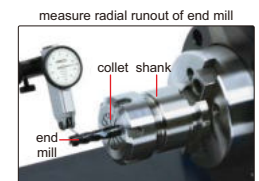

measure radial runout of end mill

DIGITAL INTERNAL CALIPER GAGES

DATA OUTPUT



2121-15

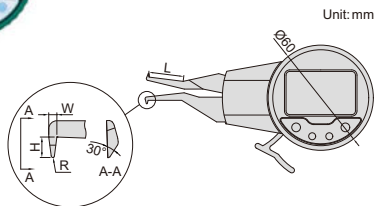
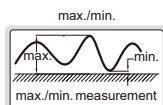

Unit: mm

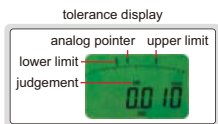

- Resolution: 0.005mm/0.0002"
- Reading in digit and analog
- Display can be rotated by 170°
- Button function: tolerance Go and No-Go display, data preset, max./min. measurement, data holding, inch/metric conversion, absolute/incremental measurement
- CR2032 battery, automatic power off
- Data output
- Optional accessory: data output cable (code 7315-30, 7302-30)

(mm)

Code	Range	Accuracy	Repeatability	L	H	W	R
2121-15	5-15mm/0.2-0.6"	±0.03mm	0.01mm	20	2	1.5	R0.3
2121-25	5-25mm/0.2-1.0"	±0.03mm	0.01mm	35	1.5	1.0	R0.3
2121-31	10-30mm/0.4-1.2"	±0.03mm	0.01mm	55	5.5	2.5	R0.5
2121-41	20-40mm/0.8-1.6"	±0.03mm	0.01mm	80	6.0	3.0	R0.5

DIGITAL INTERNAL CALIPER GAGES

DATA OUTPUT



2151-35

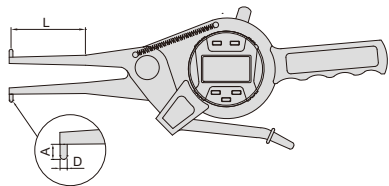
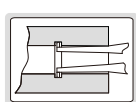

- Accuracy: ±0.04mm
- Carbide measuring tips
- Reading in digit and analog
- With transmission button and signal light
- Display can be rotated by 320°
- Button function: on/off, zero, tolerance Go and No-Go display, data preset, measuring direction change, max./min./TIR measurement, inch/metric conversion, data output, absolute/incremental measurement
- CR2032 battery, automatic power off (time is adjustable)
- Data output
- Optional accessory: data output cable (code 7315-50M, 7302-50M)

(mm)

Code	Range	Resolution	L	A	D
2151-35	15-35mm/0.6-1.4"	0.01mm/0.0005"	50	3	Ø3
2151-55	35-55mm/1.4-2.2"	0.01mm/0.0005"	80	6	Ø3
2151-75	55-75mm/2.2-3"	0.01mm/0.0005"	90	8	Ø3
2151-95	75-95mm/3-3.8"	0.01mm/0.0005"	100	8	Ø3
2151-115	95-115mm/3.8-4.6"	0.01mm/0.0005"	120	10	Ø3.2
2151-135	115-135mm/4.6-5.4"	0.01mm/0.0005"	120	10	Ø3.2

INTERNAL DIAL CALIPER GAGES



2222-15

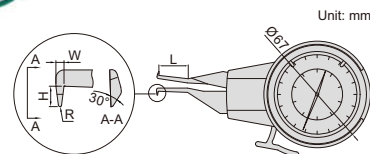

Unit: mm

(mm)

Code	Range	Graduation	Accuracy	L	H	W	R
2222-15	5-15mm	0.01mm	±0.02mm	20	2	1.5	R0.3
2222-25	5-25mm	0.01mm	±0.03mm	35	1.5	1.0	R0.3
2222-301	10-30mm	0.01mm	±0.03mm	55	5.5	2.5	R0.5
2222-401	20-40mm	0.01mm	±0.03mm	80	6.0	3.0	R0.5

INTERNAL DIAL CALIPER GAGE WITH INTERCHANGEABLE POINTS

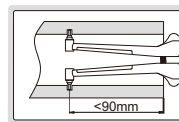

2223-153

6 pair of points (included)

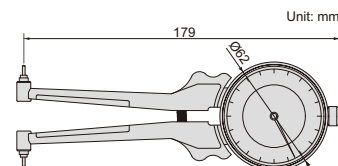

Unit: mm

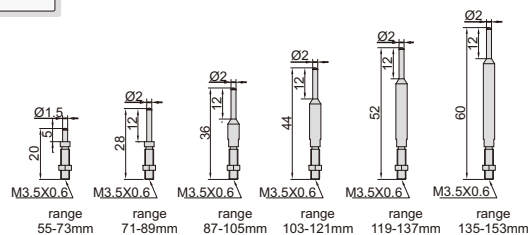

- Supplied with 6 pairs of points

Code	Range	Dial indicator range	Graduation	Accuracy
2223-153	55-153mm	2mm	0.01mm	±0.02mm

EXTERNAL DIAL CALIPER GAGE



2333-201

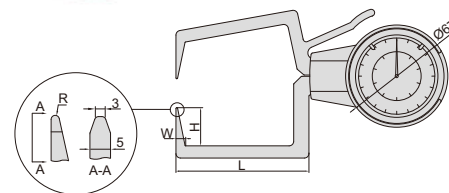

Unit: mm

(mm)

Code	Range	Graduation	Accuracy	L	H	W	R
2333-201	0-20mm	0.01mm	±0.03mm	80	25	6.5	R0.5

DIGITAL EXTERNAL CALIPER GAGE

- Carbide measuring tips
- Reading in digit and analog
- With transmission button and signal light
- Display can be rotated by 320°
- Button function: on/off, zero, tolerance Go and No-Go display, data preset, measuring direction change, max./min./TIR measurement, inch/metric conversion, absolute/incremental measurement, data output
- CR2032 battery, automatic power off (time is adjustable)
- Data output
- Optional accessory: data output cable (code 7315-50M, 7302-50M)



DATA OUTPUT

2132-20

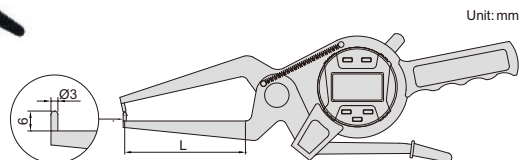
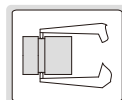

Unit: mm

Code	Range	Resolution	Accuracy	L (mm)
2132-20	0-20mm/0-0.8"	0.01mm/0.0005"	±0.04mm	60

DIGITAL EXTERNAL CALIPER GAGE

DATA OUTPUT

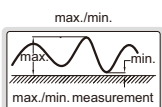

2131-21

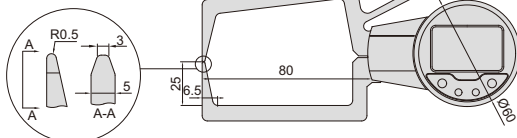

Unit: mm

- Resolution: 0.005mm/0.0002"
- Repeatability: 0.01mm
- Reading in digit and analog
- Display can be rotated by 170°
- Button function: tolerance Go and No-Go display, data preset, max./min. measurement, data holding, inch/metric conversion, absolute/incremental measurement
- CR2032 battery, automatic power off
- Data output
- Optional accessory: data output cable (code 7315-30, 7302-30)

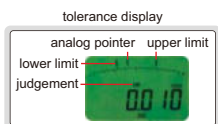

Code	Range	Accuracy
2131-21	0-20mm/0-0.8"	±0.03mm

DIGITAL THICKNESS GAGES

DATA OUTPUT

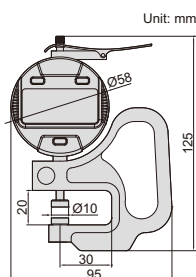

Unit: mm

2871-101



- Ceramic spindle tip and anvil
- Button function: on/off, inch/mm, zero, data preset, change measuring direction, absolute/incremental measurement
- Keep preset data in memory after restart
- CR2032 battery, automatic power off (time is adjustable)
- Data output
- Optional accessory: data output cable (code 7315-50M, 7302-50M)

Code	Range	Resolution	Accuracy
2871-10	0-10mm/0-0.4"	0.01mm/0.0005"	±0.02mm
2871-101	0-10mm/0-0.4"	0.001mm/0.00005"	±0.005mm

HIGH PRECISION DIGITAL THICKNESS GAGES

ATTENTION: RECHARGEABLE BATTERY, FOR 12 HOURS CONTINUOUS WORKING

MEASURING TIPS AND ANVILS CAN BE CUSTOM-MADE

ABSOLUTE ENCODER, THE ORIGINAL DATA REMAINS AFTER POWER OFF

DATA OUTPUT



2879-10

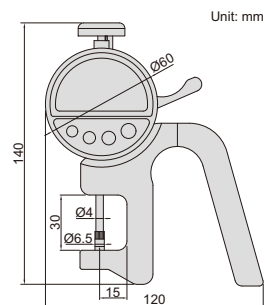

Unit: mm

- Absolute encoder, the original data remains after power off
- Button function: on/off, zero, tolerance, absolute/incremental measurement, max./min./TIR, data preset, mm/inch, data output, data hold
- Measuring force: 0.5-1N
- Reading in digital and analog
- Power: rechargeable battery, for 12 hours continuous working
- Data output
- Supplied with data output cable (keyboard format)

Code	Range	Resolution	Accuracy	Repeatability
2879-10	0-10mm/0-0.4"	0.001mm/0.00005"	±0.002mm	0.001mm
2879-101	0-10mm/0-0.4"	0.0005mm/0.00002"	±0.0015mm	0.0005mm

THICKNESS GAGES

Unit: mm



2364-10



2364-1

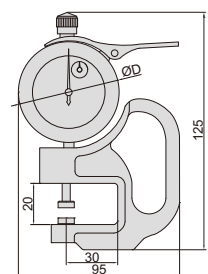

Code	Range	Graduation	Accuracy	ØD
2364-10	0-10mm	0.01mm	±0.02mm	58mm
2364-1	0-1mm	0.001mm	±0.005mm	56mm

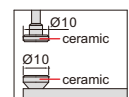

DIGITAL THICKNESS GAGE



2872-10

DATA OUTPUT

measuring tips and anvils can be custom-made



- Ceramic spindle tip and anvil
- Buttons: on/off, inch/mm, zero, data preset, change measuring direction, absolute/incremental measurement
- Keep preset data in memory after restart
- Battery CR2032, automatic power off (time is adjustable)
- Data output
- Optional accessory: data output cable (code 7315-50M, 7302-50M)

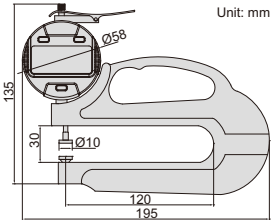

Code	Range	Resolution	Accuracy
2872-10	0-10mm/0-0.4"	0.01mm/0.0005"	±0.02mm

DIGITAL TUBE THICKNESS GAGE

DATA OUTPUT

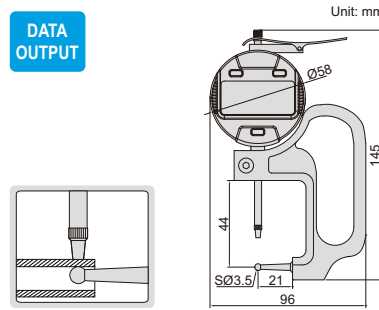

2876-10

- Buttons: on/off, inch/mm, zero, data preset, change measuring direction, absolute/incremental measurement
- Keep preset data in memory after restart
- Battery CR2032, automatic power off (time is adjustable)
- Data output
- Optional accessory: data output cable (code 7315-50M, 7302-50M)

Code	Range	Resolution	Accuracy
2876-10	0-10mm/0-0.4"	0.01mm/0.0005"	±0.02mm

THICKNESS GAGE

SUITABLE FOR JEWELLERY

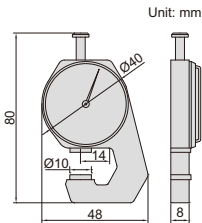

2361-10

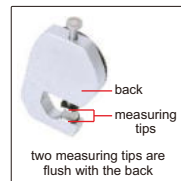
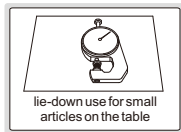

Code	Range	Graduation	Accuracy
2361-10	0-10mm	0.1mm	±0.05mm

THICKNESS GAGE

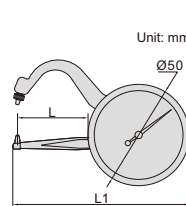

2862-101

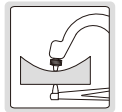

Code	Range	Graduation	Accuracy	L	L1
2862-101	0-10mm	0.05mm	±0.1mm	35mm	85mm

DIGITAL SNAP GAGE

ATTENTION: NO DATA OUTPUT



2166-12

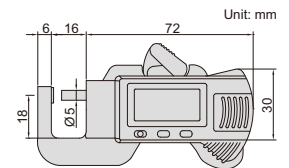

Code	Range	Resolution	Accuracy
2166-12	0-12mm/0-0.5"	0.01mm/0.0005"	±0.03mm

DIAL SNAP GAGE

ATTENTION: NOT SUITABLE FOR 0.001MM DIAL INDICATORS



digital indicator is optional

2184-50W

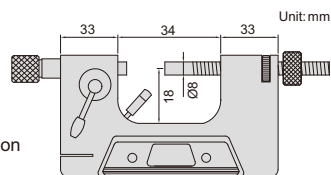

- Quick measurement for mass production
- Anvil retracting stroke: 3mm
- Measuring force: 6-9N
- Carbide measuring faces
- Optional accessory: dial indicators (graduation 0.01mm), digital indicators (resolution 0.01mm/0.0005")

Code	Range
2184-25W	0-25mm

DIGITAL 3-PURPOSE SNAP GAGE

ATTENTION: NO DATA OUTPUT

SUITABLE FOR JEWELLERY



2164-25A

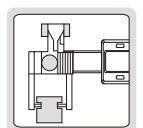

- Resolution: 0.01mm/0.0005"
- Buttons: zero, mm/inch, on/off
- Battery LR44
- Made of stainless steel

Code	Range	Accuracy
2164-25A	0-25mm/0-1"	±0.03mm

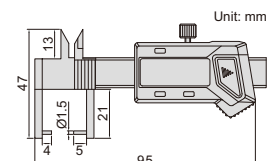

STEP AND GAP GAGE

DATA OUTPUT

- Resolution: 0.01mm/0.0005"
- Measure step height and gap width
- Buttons: on/off, set, mm/inch, preset (+, -)
- Automatic power off, move the digital unit to turn on power
- Battery CR2032
- Data output
- Made of stainless steel
- Supplied with zero setting block
- Optional accessory: data output cable (code 7315-21, 7302-21)

Code	Range	Accuracy
2168-12	0-12.7mm/0-0.5"	±0.03mm



2168-12

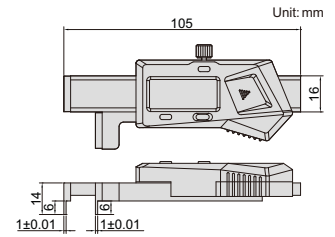

zero setting block (included)

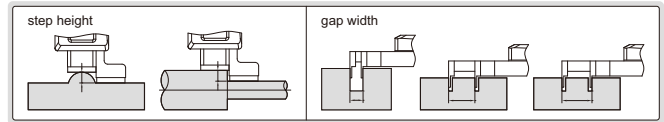
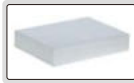

ADJUSTABLE SNAP GAGES

FAST AND ACCURATE MEASUREMENT OF CYLINDERS

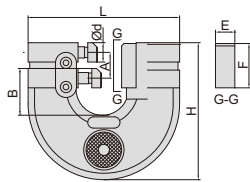

2187-19

- Used as Go/No-Go gage by setting upper and lower limits
- Flatness of anvil: 1.5µm
- Parallelism of measuring faces: range 0-32mm: 3µm range 32-89mm: 4µm range 89-300mm: 5µm

(mm)

Code	Range	L	A	B	E	F	H	Ød
2187-6	0-6mm	74	15	17.5	12.2	27.2	71.5	7
2187-13	6-13mm	85	15	26	12.2	27.2	79.5	12.3
2187-19	13-19mm	93	15	27	12.2	27.2	83	12.3
2187-25	19-25mm	100	15	33.5	12.2	27.2	89.5	12.3
2187-32	25-32mm	111	18	38.5	15.2	35.2	104	15.3
2187-38	32-38mm	117	18	41.5	15.2	35.2	105	15.3
2187-44	38-44mm	123	18	44.5	15.2	35.2	109	15.3
2187-51	44-51mm	130	18	48	15.2	35.2	117	15.3

DIAL SNAP GAGES

QUICK AND ACCURATE MEASUREMENT OF CYLINDRICAL WORKPIECES

INSPECTION CERTIFICATE



digital indicator is optional

2186-25



VIDEO

- Left anvil retracting stroke: 2mm
- Measuring force: 6-8N
- Flatness of anvil: 1.5µm
- Repeatability: 1µm
- Carbide measuring faces for anvils
- Front edges of anvils are chamfered for easy workpiece insertion
- Optional accessory: dial indicators and digital indicators (reading 0.001mm or 0.01mm)

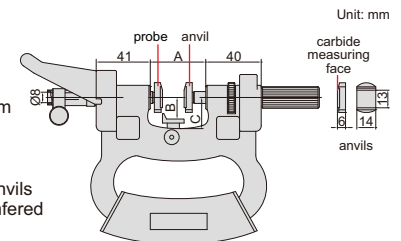

Unit: mm

(mm)

Code	Range	Parallelism of measuring faces	A	B	C
2186-25 *	0-25mm	4µm	42	11-18	20
2186-50 *	25-50mm	4µm	69	11-32	41
2186-75 *	50-75mm	5µm	94	17-41	51
2186-100 *	75-100mm	6µm	119	31-55	65

* Supplied with manufacturer inspection certificate

DIAL SNAP GAGES (ECONOMIC TYPE)

- Go/No-Go judgement for mass production
- Dial indicator: range ±0.04mm, graduation 0.001mm, accuracy 0.001mm
- IP54 dust/waterproof
- Measuring force: 5-10N
- Carbide measuring faces
- Optional accessory: gage blocks grade 0 (4101-A series), for zero setting

Code	Range	L	D
3334-25	0-25mm	28.5mm	25mm
3334-50	25-50mm	53.5mm	35mm
3334-75	50-75mm	78.5mm	47.5mm
3334-100	75-100mm	103.5mm	60mm



3334-25

ATTENTION: SETTING STANDARDS ARE NOT INCLUDED

IP54 WATERPROOF

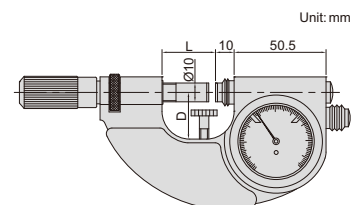

Unit: mm

CRANKSHAFT TESTERS



2841-500

- To test crankshaft deflection
- The balance block is mounted on the back of dial indicator to keep the dial indicator facing up

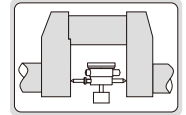
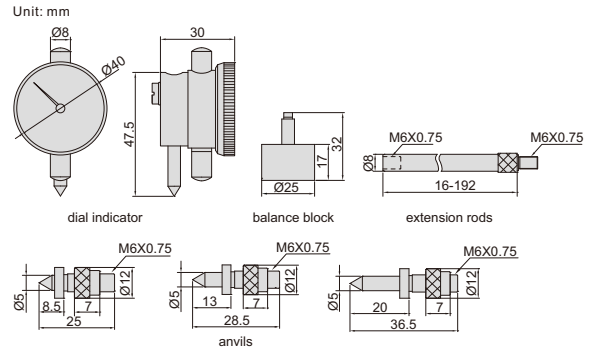

Code	Range	Dial indicator range	Extension rods	Accuracy	Graduation
2841-300	60-300mm	3mm	16mm, 32mm, 64mm, 128mm	±0.016mm	0.01mm
2841-500	60-500mm	3mm	16mm, 32mm, 64mm, 96mm, 128mm, 192mm	±0.016mm	0.01mm

DIGITAL KEYWAY DEPTH GAGE

- Measure keyway depth of cylindrical workpieces with diameter Ø10-100mm
- Button function: on/off, zero, inch/metric conversion, absolute/incremental measurement, data preset, measuring direction change
- CR2032 battery
- Automatic power off (time is adjustable)
- Data output
- Stainless steel base
- Pointed tip
- Optional accessory: data output cable (code 7315-50M, 7302-40M)

2182-25

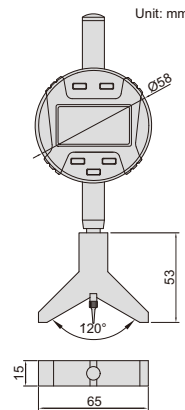

DATA OUTPUT

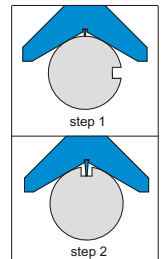
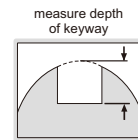

Code	Range	Accuracy	Resolution
2182-25	0-25.4mm/0-1"	±0.02mm	0.01mm/0.0005"

STEEL GAGE BLOCK SETS



4100-87

- Made of alloy steel
- Meet ISO3650
- Gage blocks ≥ 125mm have clamping holes
- Supplied with manufacturer inspection certificate

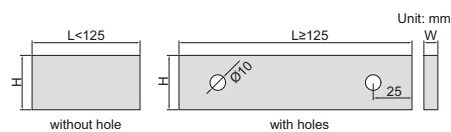

Dimension:	(mm)		
Size (L)	W	H	
0.5 ≤ L ≤ 10mm	9	30	
L > 10mm	9	35	

Blocks per set	Gage blocks included in set			Code		
	Size (mm)	Step (mm)	Quantity	Grade 1	Grade 2	
122	1.0005	0.001	1	4100-1122	4100-2122	
	1.001-1.009		9			
	1.01-1.49		0.01			49
	1.6-1.9		0.1			4
	0.5-24.5		0.5			49
	30-100		10			8
112	1.0005	0.001	1	4100-1112	4100-2112	
	1.001-1.009		9			
	1.01-1.49		0.01			49
	0.5-24.5		0.5			49
	25-100		25			4
103	1.005	0.01	1	4100-1103	4100-2103	
	1.01-1.49		49			
	0.5-24.5		49			
	25-100		25			
			4			

Blocks per set	Gage blocks included in set			Code			
	Size (mm)	Step (mm)	Quantity	Grade 0	Grade 1	Grade 2	
87	1.001-1.009	0.001	9	4100-87	4100-187	4100-287	
	1.01-1.49	0.01	49				
	0.5-9.5	0.5	19				
	10-100	10	10				
47	1.005	0.01	1	4100-47	4100-147	4100-247	
	1.01-1.19		0.1				19
	1.2-1.9		1				8
	1-9		1				9
	10-100		10				10
32	1.005	0.01	1	4100-32	4100-132	4100-232	
	1.01-1.09		0.01				9
	1.1-1.9		0.1				9
	1-9		1				9
	10-30		10				3
	50						1
8	125-175	25	3	4100-8	4100-18	4100-28	
	200-250	50	2				
	300-500	100	3				

INDIVIDUAL STEEL GAGE BLOCKS



CUSTOM-MADE
CAN SUPPLY ANY SIZES FROM 0.5 TO 1000MM,
SUCH AS 72.672MM

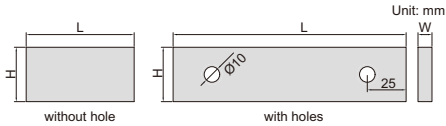

4101-A70

4101-A200

- Grade 0, 1 and 2 gage blocks are available
- Made of alloy steel
- Meet ISO3650
- Gage blocks with clamping holes: 125, 150, 175, 200, 250, 300, 400, 500, 600, 700, 800, 900, 1000mm
- Supplied with manufacturer inspection certificate

Dimension: (mm)

Size (L)	W	H
0.5 ≤ L ≤ 10mm	9	30
L > 10mm	9	35

Grade 0 (mm)

Code	Size
4101-A1	1
4101-A10	10
4101-A100	100

Grade 2 (mm)

Code	Size
4101-C1	1
4101-C10	10
4101-C100	100
4101-C200	200
4101-C250	250
4101-C300	300

Grade 1 (mm)		Grade 1 (mm)		Grade 1 (mm)		Grade 1 (mm)		Grade 1 (mm)	
Code	Size	Code	Size	Code	Size	Code	Size	Code	Size
4101-BD5	0.5	4101-B1D12	1.12	4101-B1D4	1.4	4101-B5	5	4101-B22	22
4101-B1	1	4101-B1D15	1.15	4101-B1D42	1.42	4101-B5D5	5.5	4101-B23	23
4101-B1D001	1.001	4101-B1D16	1.16	4101-B1D43	1.43	4101-B6	6	4101-B25	25
4101-B1D002	1.002	4101-B1D18	1.18	4101-B1D45	1.45	4101-B7	7	4101-B30	30
4101-B1D003	1.003	4101-B1D19	1.19	4101-B1D46	1.46	4101-B7D5	7.5	4101-B35	35
4101-B1D004	1.004	4101-B1D2	1.2	4101-B1D47	1.47	4101-B8	8	4101-B40	40
4101-B1D005	1.005	4101-B1D21	1.21	4101-B1D48	1.48	4101-B8D5	8.5	4101-B45	45
4101-B1D006	1.006	4101-B1D22	1.22	4101-B1D49	1.49	4101-B9	9	4101-B50	50
4101-B1D009	1.009	4101-B1D24	1.24	4101-B1D5	1.5	4101-B9D5	9.5	4101-B60	60
4101-B1D01	1.01	4101-B1D25	1.25	4101-B1D6	1.6	4101-B10	10	4101-B70	70
4101-B1D02	1.02	4101-B1D26	1.26	4101-B1D7	1.7	4101-B11	11	4101-B75	75
4101-B1D03	1.03	4101-B1D27	1.27	4101-B1D8	1.8	4101-B12	12	4101-B80	80
4101-B1D04	1.04	4101-B1D3	1.3	4101-B1D9	1.9	4101-B13	13	4101-B90	90
4101-B1D05	1.05	4101-B1D32	1.32	4101-B2	2	4101-B14	14	4101-B100	100
4101-B1D06	1.06	4101-B1D33	1.33	4101-B2D5	2.5	4101-B15	15	4101-B125	125
4101-B1D07	1.07	4101-B1D34	1.34	4101-B3	3	4101-B16	16	4101-B131D4	131.4
4101-B1D08	1.08	4101-B1D35	1.35	4101-B3D5	3.5	4101-B18	18	4101-B150	150
4101-B1D09	1.09	4101-B1D36	1.36	4101-B4	4	4101-B20	20		
4101-B1D1	1.1	4101-B1D37	1.37	4101-B4D5	4.5	4101-B21	21		

CALIPER INSPECTION GAGE BLOCK AND RING GAGE SET



- Gage blocks meet ISO3650
- Ring gages meet DIN2250-1:2008
- Supplied with manufacturer inspection certificate

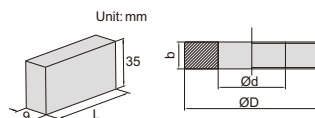

4176-30

Ring gage sizes:

diameter (Ød)*	b	ØD
Ø4mm	5mm	22mm
Ø25mm	14mm	53mm

* The size of the ring gage when supplied may have deviation. For example, the size Ø25mm may be 24.996mm

(mm)

Code	Material	Gage blocks included in set (L)	Ring gages included in set (Ød)	Applicable calipers
4176-30	alloy steel	30, 41.3, 131.4	4, 25	0-150

CALIPER INSPECTION GAGE BLOCK SET



- Meet ISO3650/grade 2
- Supplied with manufacturer inspection certificate

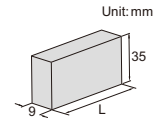

4108-3005

Code	Material	Gage blocks included in set (L)	Applicable calipers
4108-3005	alloy steel	30, 41.3, 131.4, 243.5, 281.2	0-150, 0-200, 0-300

MICROMETER INSPECTION GAGE BLOCK SET



- Meet ISO3650/grade 0
- One piece of optical flat is included (size Ø30x12mm)
- Supplied with manufacturer inspection certificate

optical flat (included)



4160-10

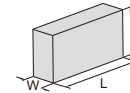

Dimension:

Size (L)	W	H
0.5 ≤ L ≤ 10mm	9mm	30mm
L > 10mm	9mm	35mm

Code	Material	Gage blocks included in set	Applicable micrometer
4160-10	alloy steel	2.5mm, 5.1mm, 7.7mm, 10.3mm, 12.9mm, 15mm, 17.6mm, 20.2mm, 22.8mm, 25mm	0-25mm



CALIPER/HEIGHT GAGE CHECKERS

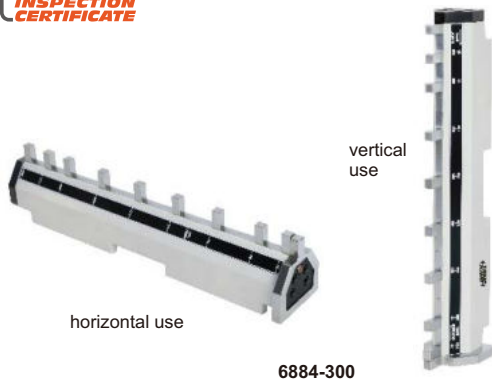

6884-300

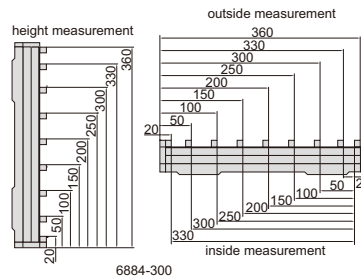

6884-300

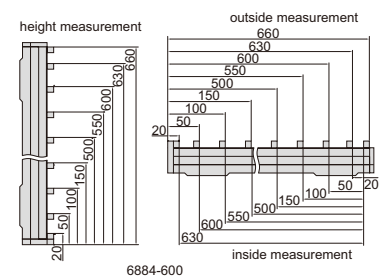

6884-600

Unit: mm

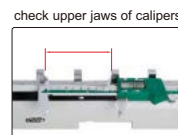

check upper jaws of calipers

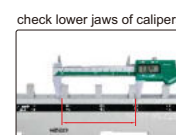

check lower jaws of calipers

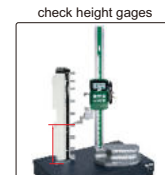

check height gages

- To check calipers and height gages
- Constructed with steel gage blocks

Code	Size	Range of inside measurement	Range of outside measurement	Range of height measurement	Accuracy
6884-300*	0-300mm	20, 50, 100, 150, 200, 250, 300, 330	20, 50, 100, 150, 200, 250, 300, 330, 360	20, 50, 100, 150, 200, 250, 300, 330, 360	±3µm
6884-600*	0-600mm	20, 50, 100, 150, 200, 250, 300, 350, 400, 450, 500, 550, 600, 630	20, 50, 100, 150, 200, 250, 300, 350, 400, 450, 500, 550, 600, 630, 660	20, 50, 100, 150, 200, 250, 300, 350, 400, 450, 500, 550, 600, 630, 660	±5µm

*Supplied with manufacturer inspection certificate

INSIDE MICROMETER ACCESSORY

- Supplied with a pair of 5mm carbide gage blocks

Code
6884-A10*



6884-A10



*Supplied with manufacturer inspection certificate

PIN GAGE SETS

Code	Diameter Ød (mm)	Step	Pin gages per set
4166-2S	1.00, 1.01, 1.02, … 2.00	0.01mm	101
4166-3S	2.00, 2.01, 2.02, … 3.00	0.01mm	101
4166-4S	3.00, 3.01, 3.02, … 4.00	0.01mm	101
4166-5S	4.00, 4.01, 4.02, … 5.00	0.01mm	101
4166-6S	5.00, 5.01, 5.02, … 6.00	0.01mm	101
4166-7S	6.00, 6.01, 6.02, … 7.00	0.01mm	101
4166-8S	7.00, 7.01, 7.02, … 8.00	0.01mm	101
4166-9S	8.00, 8.01, 8.02, … 9.00	0.01mm	101
4166-10S	9.00, 9.01, 9.02, … 10.00	0.01mm	101



Unit: mm



4166-10

Code	Diameter Ød (mm)	Step	Pin gages per set
4166-411	1.0, 1.1, 1.2, … 5.0	0.01mm	41
4166-511	5.0, 5.1, 5.2, … 10.0	0.01mm	51
4166-512	10.0, 10.1, 10.2, … 15.0	0.01mm	51
4166-513	15.0, 15.1, 15.2, … 20.0	0.01mm	51

- Meet DIN2269, grade 1
- Made of alloy steel
- Hardness HRC62-65
- Diameter accuracy: $\pm 1\mu\text{m}$

Code	Diameter Ød (mm)	Step	Pin gages per set
4166-0D	0.20, 0.21, 0.22, … 0.50	0.01mm	31
4166-1	0.50, 0.51, 0.52, … 1.00	0.01mm	51
4166-1D	1.00, 1.01, 1.02, … 1.50	0.01mm	51
4166-2	1.50, 1.51, 1.52, … 2.00	0.01mm	51
4166-2D	2.00, 2.01, 2.02, … 2.50	0.01mm	51
4166-3	2.50, 2.51, 2.52, … 3.00	0.01mm	51
4166-3D	3.00, 3.01, 3.02, … 3.50	0.01mm	51
4166-4	3.50, 3.51, 3.52, … 4.00	0.01mm	51
4166-4D	4.00, 4.01, 4.02, … 4.50	0.01mm	51
4166-5	4.50, 4.51, 4.52, … 5.00	0.01mm	51
4166-5D	5.00, 5.01, 5.02, … 5.50	0.01mm	51
4166-6	5.50, 5.51, 5.52, … 6.00	0.01mm	51
4166-6D	6.00, 6.01, 6.02, … 6.50	0.01mm	51
4166-7	6.50, 6.51, 6.52, … 7.00	0.01mm	51
4166-7D	7.00, 7.01, 7.02, … 7.50	0.01mm	51
4166-8	7.50, 7.51, 7.52, … 8.00	0.01mm	51
4166-8D	8.00, 8.01, 8.02, … 8.50	0.01mm	51
4166-9	8.50, 8.51, 8.52, … 9.00	0.01mm	51
4166-9D	9.00, 9.01, 9.02, … 9.50	0.01mm	51
4166-10	9.50, 9.51, 9.52, … 10.00	0.01mm	51

Code	Diameter Ød (mm)	Step	Pin gages per set
4166-10D	10.00, 10.01, 10.02, … 10.50	0.01mm	51
4166-11	10.50, 10.51, 10.52, … 11.00	0.01mm	51
4166-11D	11.00, 11.01, 11.02, … 11.50	0.01mm	51
4166-12	11.50, 11.51, 11.52, … 12.00	0.01mm	51
4166-12D	12.00, 12.01, 12.02, … 12.50	0.01mm	51
4166-13	12.50, 12.51, 12.52, … 13.00	0.01mm	51
4166-13D	13.00, 13.01, 13.02, … 13.50	0.01mm	51
4166-14	13.50, 13.51, 13.52, … 14.00	0.01mm	51
4166-14D	14.00, 14.01, 14.02, … 14.50	0.01mm	51
4166-15	14.50, 14.51, 14.52, … 15.00	0.01mm	51
4166-15D	15.00, 15.01, 15.02, … 15.50	0.01mm	51
4166-16	15.50, 15.51, 15.52, … 16.00	0.01mm	51
4166-16D	16.00, 16.01, 16.02, … 16.50	0.01mm	51
4166-17	16.50, 16.51, 16.52, … 17.00	0.01mm	51
4166-17D	17.00, 17.01, 17.02, … 17.50	0.01mm	51
4166-18	17.50, 17.51, 17.52, … 18.00	0.01mm	51
4166-18D	18.00, 18.01, 18.02, … 18.50	0.01mm	51
4166-19	18.50, 18.51, 18.52, … 19.00	0.01mm	51
4166-19D	19.00, 19.01, 19.02, … 19.50	0.01mm	51
4166-20	19.50, 19.51, 19.52, … 20.00	0.01mm	51

PIN GAGE HANDLES (OPERATED WITHOUT WRENCH)

- Operated without wrench
- Made of aluminum
- Pin gages can be installed



7342-M1



Code	Applicable pin gage diameter
7342-M0	0.30-1.50mm/0.011-0.060"
7342-M1	1.51-6.35mm/0.061-0.250"
7342-M2	6.36-12.70mm/0.251-0.500"
7342-M3	12.71-15.88mm/0.501-0.625"

Code	Applicable pin gage diameter
7342-M4	15.89-19.00mm/0.626-0.750"
7342-M5	19.01-21.13mm/0.751-0.832"
7342-M6	21.14-23.27mm/0.833-0.916"
7342-M7	23.28-25.40mm/0.917-1.000"

PIN GAGE HANDLES (OPERATED WITH WRENCH)



handle



brass clamping bush (0.2~7.14mm)



aluminum clamping bush (7.14~24.80mm)

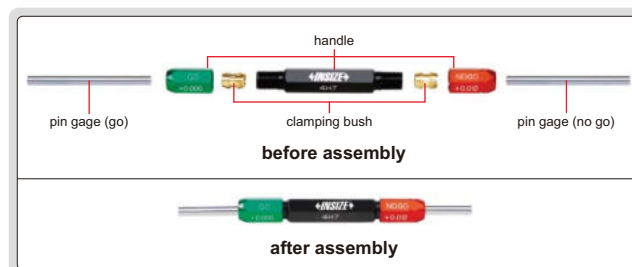

- Wrench is needed to install pins
- Clamping bushes (0.2~7.14mm) are made of brass, clamping bushes (7.14~24.80mm) are made of aluminum

Code	Applicable pin gage diameter	Including	
		Handle	Clamping bush (mm)
7341-0S	0.2-1.02mm	1 pc	6 pairs (the clamping range are 0.2-0.38, 0.38-0.51, 0.51-0.64, 0.64-0.76, 0.76-0.89, 0.89-1.02)
7341-1S	1.02-1.91mm	1 pc	7 pairs (the clamping range are 1.02-1.14, 1.14-1.27, 1.27-1.40, 1.40-1.52, 1.52-1.65, 1.65-1.78, 1.78-1.91)
7341-2S	1.91-3.33mm	1 pc	8 pairs (the clamping range are 1.91-2.08, 2.08-2.26, 2.26-2.44, 2.44-2.62, 2.62-2.79, 2.79-2.97, 2.97-3.15, 3.15-3.33)
7341-3S	3.33-4.57mm	1 pc	7 pairs (the clamping range are 3.33-3.51, 3.51-3.68, 3.68-3.86, 3.86-4.04, 4.04-4.22, 4.22-4.39, 4.39-4.57)
7341-4S	4.57-5.79mm	1 pc	6 pairs (the clamping range are 4.57-4.78, 4.78-4.98, 4.98-5.18, 5.18-5.38, 5.38-5.59, 5.59-5.79)
7341-5S	5.79-7.14mm	1 pc	6 pairs (the clamping range are 5.79-5.99, 5.99-6.20, 6.20-6.40, 6.40-6.63, 6.63-6.88, 6.88-7.14)
7341-6S	7.14-8.66mm	1 pc	6 pairs (the clamping range are 7.14-7.39, 7.39-7.65, 7.65-7.90, 7.90-8.15, 8.15-8.41, 8.41-8.66)

Code	Applicable pin gage diameter	Handle	Including
			Clamping bush (mm)
7341-7S	8.66-10.31mm	1 pc	6 pairs (the clamping range are 8.66-8.92, 8.9-9.17, 9.17-9.42, 9.42-9.70, 9.70-10.01, 10.01-10.31)
7341-8S	10.31-11.81mm	1 pc	4 pairs (the clamping range are 10.31-10.67, 10.67-11.05, 11.05-11.43, 11.43-11.81)
7341-9S	11.81-12.95mm	1 pc	3 pairs (the clamping range are 11.81-12.19, 12.19-12.57, 12.57-12.95)
7341-10S	12.95-14.71mm	1 pc	4 pairs (the clamping range are 12.95-13.51, 13.51-13.89, 13.89-14.30, 14.30-14.71)
7341-11S	14.71-16.13mm	1 pc	4 pairs (the clamping range are 14.71-15.09, 15.09-15.49, 15.49-15.88, 15.88-16.13)
7341-12S	16.13-17.88mm	1 pc	4 pairs (the clamping range are 16.13-16.66, 16.66-17.07, 17.07-17.48, 17.48-17.88)
7341-13S	17.88-19.30mm	1 pc	4 pairs (the clamping range are 17.88-18.26, 18.26-18.67, 18.67-19.05, 19.05-19.30)
7341-15S	19.30-24.80mm	1 pc	8 pairs (the clamping range are 19.30-19.84, 19.84-20.62, 20.62-21.41, 21.41-22.23, 22.23-23.03, 23.03-23.80, 23.80-24.59, 24.59-24.80)

SETTING RINGS

CAN SUPPLY CUSTOM SETTING RINGS FROM Ø1.500MM TO Ø400.000MM, FOR EXAMPLE, Ø17.085MM

- For zero setting of inside micrometers, three points internal micrometers and bore gages
- The size marked on the setting ring is checked at the direction of the marking line
- Deviation (difference between the ordered size and the size marked on the setting ring when supplied): For example, the ordered size is Ø10.125mm, the size marked on the setting ring when supplied may be Ø10.135mm
- Meet DIN2250-1:2008

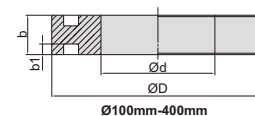
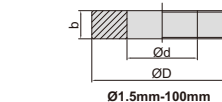

(mm)

Diameter d**	b	ØD	Deviation	Roundness and cylindricity
Ø1.5-2.5	4mm	22mm	±10.0µm	0.3µm
Ø2.5-3	5mm	22mm	±10.0µm	0.3µm
Ø3-5	5mm	22mm	±10.0µm	0.4µm
Ø5-10	8mm	32mm	±10.0µm	0.4µm
Ø10-15	10mm	38mm	±10.0µm	0.5µm
Ø15-18	12mm	45mm	±10.0µm	0.5µm
Ø18-20	12mm	45mm	±10.0µm	0.6µm
Ø20-25	14mm	53mm	±10.0µm	0.6µm
Ø25-30	16mm	63mm	±10.0µm	0.6µm
Ø30-32	16mm	63mm	±10.0µm	0.7µm
Ø32-40	18mm	71mm	±10.0µm	0.7µm
Ø40-50	20mm	85mm	±10.0µm	0.7µm
Ø50-60	20mm	100mm	±10.0µm	0.8µm
Ø60-70	24mm	112mm	±10.0µm	0.8µm
Ø70-80	24mm	125mm	±10.0µm	0.8µm
Ø80-90	24mm	140mm	±10.0µm	1.0µm
Ø90-100	24mm	160mm	±10.0µm	1.0µm

** For example Ø3-5mm means Ø3mm< diameter d ≤ Ø5mm

(mm)

Diameter d**	b	b1	ØD	Deviation	Roundness and cylindricity
Ø100-110	30mm	8mm	164mm	±10.0µm	1.0µm
Ø110-130	34mm	10mm	192mm	±10.0µm	1.0µm
Ø130-150	34mm	10mm	220mm	±10.0µm	1.2µm
Ø150-170	36mm	10mm	248mm	±10.0µm	1.5µm
Ø170-190	36mm	10mm	276mm	±10.0µm	1.5µm
Ø190-210	38mm	10mm	300mm	±10.0µm	1.5µm
Ø210-230	38mm	10mm	324mm	±10.0µm	2.5µm
Ø230-250	40mm	12mm	350mm	±10.0µm	2.5µm
Ø250-270	40mm	12mm	375mm	±10.0µm	3.0µm
Ø270-290	42mm	12mm	400mm	±10.0µm	3.0µm
Ø290-300	42mm	12mm	425mm	±10.0µm	3.0µm
Ø300-320	42mm	12mm	430mm	±10.0µm	4.0µm
Ø320-330	42mm	12mm	440mm	±10.0µm	4.0µm
Ø330-340	42mm	12mm	450mm	±10.0µm	4.0µm
Ø340-350	42mm	12mm	460mm	±10.0µm	4.0µm
Ø350-360	42mm	12mm	470mm	±10.0µm	4.0µm
Ø360-370	42mm	12mm	480mm	±10.0µm	4.0µm
Ø370-380	42mm	12mm	490mm	±10.0µm	4.0µm
Ø380-390	42mm	12mm	500mm	±10.0µm	4.0µm
Ø390-400	42mm	12mm	510mm	±10.0µm	4.0µm

Code	Size
6312-1D5*	Ø1.5mm
6312-2*	Ø2mm
6312-2D5*	Ø2.5mm
6312-3*	Ø3mm
6312-3D5*	Ø3.5mm
6312-4*	Ø4mm
6312-4D5*	Ø4.5mm
6312-5*	Ø5mm
6312-5D5*	Ø5.5mm
6312-6*	Ø6mm
6312-6D5*	Ø6.5mm
6312-7*	Ø7mm
6312-7D5*	Ø7.5mm
6312-8*	Ø8mm
6312-8D5*	Ø8.5mm
6312-9*	Ø9mm
6312-9D5*	Ø9.5mm
6312-10*	Ø10mm
6312-10D5*	Ø10.5mm
6312-11*	Ø11mm
6312-11D5*	Ø11.5mm
6312-12*	Ø12mm
6312-12D5*	Ø12.5mm
6312-13*	Ø13mm
6312-13D5*	Ø13.5mm
6312-14*	Ø14mm
6312-14D5*	Ø14.5mm

Code	Size
6312-15*	Ø15mm
6312-15D5*	Ø15.5mm
6312-16*	Ø16mm
6312-16D5*	Ø16.5mm
6312-17*	Ø17mm
6312-17D5*	Ø17.5mm
6312-18*	Ø18mm
6312-18D5*	Ø18.5mm
6312-19*	Ø19mm
6312-19D5*	Ø19.5mm
6312-20*	Ø20mm
6312-20D5*	Ø20.5mm
6312-21*	Ø21mm
6312-21D5*	Ø21.5mm
6312-22*	Ø22mm
6312-22D5*	Ø22.5mm
6312-23*	Ø23mm
6312-23D5*	Ø23.5mm
6312-24*	Ø24mm
6312-24D5*	Ø24.5mm
6312-25*	Ø25mm
6312-25D5*	Ø25.5mm
6312-26*	Ø26mm
6312-26D5*	Ø26.5mm
6312-27*	Ø27mm
6312-27D5*	Ø27.5mm
6312-28*	Ø28mm

Code	Size
6312-28D5*	Ø28.5mm
6312-29*	Ø29mm
6312-29D5*	Ø29.5mm
6312-30*	Ø30mm
6312-31*	Ø31mm
6312-32*	Ø32mm
6312-33*	Ø33mm
6312-34*	Ø34mm
6312-35*	Ø35mm
6312-36*	Ø36mm
6312-37*	Ø37mm
6312-38*	Ø38mm
6312-39*	Ø39mm
6312-40*	Ø40mm
6312-41*	Ø41mm
6312-42*	Ø42mm
6312-43*	Ø43mm
6312-44*	Ø44mm
6312-45*	Ø45mm
6312-46*	Ø46mm
6312-47*	Ø47mm
6312-48*	Ø48mm
6312-49*	Ø49mm
6312-50*	Ø50mm
6312-55*	Ø55mm
6312-60*	Ø60mm
6312-62*	Ø62mm

Code	Size
6312-65*	Ø65mm
6312-70*	Ø70mm
6312-75*	Ø75mm
6312-80*	Ø80mm
6312-85*	Ø85mm
6312-87*	Ø87mm
6312-90*	Ø90mm
6312-95*	Ø95mm
6312-100*	Ø100mm
6312-112D5*	Ø112.5mm
6312-125*	Ø125mm
6312-137D5*	Ø137.5mm
6312-150*	Ø150mm
6312-162D5*	Ø162.5mm
6312-175*	Ø175mm
6312-187D5*	Ø187.5mm
6312-200*	Ø200mm
6312-212D5*	Ø212.5mm
6312-225*	Ø225mm
6312-237D5*	Ø237.5mm
6312-250*	Ø250mm
6312-262D5*	Ø262.5mm
6312-275*	Ø275mm
6312-287D5*	Ø287.5mm
6312-300*	Ø300mm
6312-350*	Ø350mm
6312-400*	Ø400mm

*Supplied with manufacturer inspection certificate

PLAIN PLUG GAGES

- Supplied with Go and No-Go gages together
- Class H7
- Hardness HRC 60±2
- Standard DIN7150-2



4124-12

CUSTOM-MADE
OTHER CLASSES ARE AVAILABLE, SUCH AS H8, H9
OTHER DIAMETERS ARE AVAILABLE, SUCH AS 19.003mm
OTHER LENGTHS ARE AVAILABLE, SUCH AS 70mm



type A

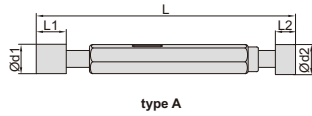

type A



type B

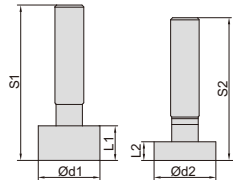

type B

Size tolerance of H7

Diameter Ød	Type	Size tolerance of Go gage (µm)	Size tolerance of No-Go gage (µm)	L1	L2	L	S1, S2
≥2, ≤3	A	+0.5 / +2.5	+9 / +11	6.5	4.5	62	–
>3, ≤6	A	+0.75 / +3.25	+10.75 / +13.25	8	6	74	–
>6, ≤10	A	+0.75 / +3.25	+13.75 / +16.25	10	7	87	–
>10, ≤14	A	+1 / +4	+16.5 / +19.5	12	8	99	–
>14, ≤18	A	+1 / +4	+16.5 / +19.5	14	10	114	–
>18, ≤24	A	+1 / +5	+19 / +23	16	12	132	–
>24, ≤30	A	+1 / +5	+19 / +23	18	14	136	–
>30, ≤40	A	+1.5 / +5.5	+23 / +27	20	15	155	–
>40, ≤50	A	+1.5 / +5.5	+23 / +27	25	18	169	–
>50, ≤65	B	+1.5 / +6.5	+27.5 / +32.5	30	18	–	164, 152
>65, ≤80	B	+1.5 / +6.5	+27.5 / +32.5	35	25	–	169, 159
>80, ≤100	B	+2 / +8	+32 / +38	35	25	–	169, 159

Code	Diameter	Type	Code	Diameter	Type	Code	Diameter	Type	Code	Diameter	Type	Code	Diameter	Type
4124-2	2mm	A	4124-13	13mm	A	4124-24	24mm	A	4124-38	38mm	A	4124-52	52mm	B
4124-3	3mm	A	4124-14	14mm	A	4124-25	25mm	A	4124-39	39mm	A	4124-55	55mm	B
4124-4	4mm	A	4124-15	15mm	A	4124-26	26mm	A	4124-40	40mm	A	4124-60	60mm	B
4124-5	5mm	A	4124-16	16mm	A	4124-28	28mm	A	4124-41	41mm	A	4124-65	65mm	B
4124-6	6mm	A	4124-17	17mm	A	4124-29	29mm	A	4124-42	42mm	A	4124-70	70mm	B
4124-7	7mm	A	4124-18	18mm	A	4124-30	30mm	A	4124-44	44mm	A	4124-75	75mm	B
4124-8	8mm	A	4124-19	19mm	A	4124-31	31mm	A	4124-45	45mm	A	4124-80	80mm	B
4124-9	9mm	A	4124-20	20mm	A	4124-32	32mm	A	4124-46	46mm	A	4124-85	85mm	B
4124-10	10mm	A	4124-21	21mm	A	4124-34	34mm	A	4124-47	47mm	A	4124-100	100mm	B
4124-11	11mm	A	4124-22	22mm	A	4124-35	35mm	A	4124-49	49mm	A			
4124-12	12mm	A	4124-23	23mm	A	4124-36	36mm	A	4124-50	50mm	A			

METRIC THREAD PLUG GAGES

- Supplied with Go and No-Go gages together
- Standard ISO1502
- Supplied with manufacturer inspection certificate



4130-10



Size (mm)		Code		
Nominal diameter	Pitch	Class 6H	Class 6G	Class 4H
M0.8	0.2	4130-D8	4130-D8G	–
M0.9	0.225	4130-D9	–	–
M1	0.25	4130-1	–	–
M1.2	0.25	4130-1D2	–	4130-1D2H
M1.4	0.3	4130-1D4	–	4130-1D4H
M1.6	0.35	4130-1D6	4130-1D6G	4130-1D6H
M1.8	0.35	4130-1D8	–	–
M2	0.4	4130-2	4130-2G	4130-2H
M2.2	0.45	4130-2D2	–	–
M2.3	0.4	4130-2D3	–	–
M2.5	0.45	4130-2D5	4130-2D5G	4130-2D5H
M2.6	0.45	4130-2D6	–	–
M3	0.5	4130-3	4130-3G	4130-3H
M3.5	0.6	4130-3D5	4130-3D5G	–
M4	0.7	4130-4	4130-4G	4130-4H
M4.5	0.75	4130-4D5	–	–
M5	0.8	4130-5	4130-5G	–
M6	1	4130-6	4130-6G	4130-6H
M7	1	4130-7	–	–
M8	1.25	4130-8	–	–

Size (mm)		Code		
Nominal diameter	Pitch	Class 6H	Class 6G	Class 4H
M9	1.25	4130-9	4130-9G	–
M10	1.5	4130-10	4130-10G	–
M11	1.5	4130-11	–	–
M12	1.75	4130-12	4130-12G	–
M14	2	4130-14	4130-14G	–
M16	2	4130-16	4130-16G	–
M18	2.5	4130-18	4130-18G	4130-18H
M20	2.5	4130-20	4130-20G	–
M22	2.5	4130-22	–	–
M24	3	4130-24	–	–
M27	3	4130-27	–	–
M30	3.5	4130-30	4130-30G	–
M33	3.5	4130-33	–	–
M36	4	4130-36	–	4130-36H
M39	4	4130-39	–	–
M45	4.5	4130-45	–	–
M48	5	4130-48	–	–
M56	5.5	4130-56	–	–
M60	5.5	4130-60	–	–

Set (class 6H)

Code	Thread plug gages included
4130-S7	M3x0.5 (4130-3), M4x0.7 (4130-4), M5x0.8 (4130-5), M6x1 (4130-6), M8x1.25 (4130-8), M10x1.5 (4130-10), M12x1.75 (4130-12)

METRIC FINE THREAD PLUG GAGES

- Supplied with Go and No-Go gages together
- Standard ISO1502
- Supplied with manufacturer inspection certificate



4139-20G

Code example:
"1A" stands for "4139-1A"

Size (mm)		Code (4139)			Size (mm)		Code (4139)			Size (mm)		Code (4139)	
Nominal diameter	Pitch	Class 6H	Class 6G	Class 4H	Nominal diameter	Pitch	Class 6H	Class 6G	Class 4H	Nominal diameter	Pitch	Class 6H	Class 6G
M1	0.2	-1A	-	-	M19	1	-19P	-	-	M38	0.75	-38L	-
M1.6	0.2	-1D6A	-1D6AG	-		0.5	-20G	-	-		1.5	-38R	-
M1.8	0.2	-1D8A	-	-	M20	1	-20P	-20PG	-		2	-38T	-
M2	0.2	-2A	-2AG	-		1.5	-20R	-20RG	-	M39	1	-39P	-
	0.25	-2B	-2BG	-		2	-20T	-	-		1.5	-39R	-
M2.5	0.2	-2D5A	-	-	M21	1	-21P	-	-		2	-39T	-
	0.25	-2D5B	-	-		1.5	-21R	-	-		3	-39V	-
M3	0.25	-3B	-	-		0.5	-22G	-	-	M40	1	-40P	-
	0.35	-3D	-	-	M22	1	-22P	-22PG	-		2	-40T	-
M3.5	0.35	-3D5D	-	-		1.5	-22R	-22RG	-		1	-42P	-
	0.5	-3D5G	-	-		2	-22T	-	-	M42	1.5	-42R	-42RG
M4	0.5	-4G	-4GG	-4GH		0.5	-24G	-	-		3	-42V	-42VG
M4.5	0.5	-4D5G	-	-	M24	1	-24P	-24PG	-		1	-45P	-
M5	0.25	-5B	-	-		1.25	-24Q	-	-	M45	1.5	-45R	-45RG
	0.5	-5G	-5GG	-		1.5	-24R	-24RG	-		2	-45T	-
M6	0.25	-6B	-6BG	-		2	-24T	-24TG	-		3	-45V	-
	0.5	-6G	-	-		0.5	-25G	-	-		1	-48P	-
M7	0.5	-7G	-	-	M25	1	-25P	-	-		1.5	-48R	-
M8	0.5	-8G	-	-		1.5	-25R	-	-	M48	2	-48T	-
	1	-8P	-8PG	-		2	-25T	-	-		3	-48V	-
M9	0.5	-9G	-9GG	-	M26	1	-26P	-	-		1	-52P	-
	0.75	-9L	-	-		1.5	-26R	-	-	M52	1.5	-52R	-
	1	-9P	-	-		0.5	-27G	-	-		3	-52V	-
M10	0.5	-10G	-	-		1	-27P	-27PG	-		4	-52X	-
	1	-10P	-10PG	-	M27	1.5	-27R	-	-27RH	M55	1.5	-55R	-
	1.25	-10Q	-10QG	-		2	-27T	-	-27TH		2	-55T	-
M11	0.5	-11G	-	-		1	-28P	-	-	M56	1.5	-56R	-
	1	-11P	-	-	M28	1.5	-28R	-28RG	-		3	-56V	-
M12	0.5	-12G	-12GG	-12GH		2	-28T	-	-		1	-60P	-
	1	-12P	-12PG	-		0.75	-30L	-	-	M58	2	-60T	-
	1.25	-12Q	-12QG	-		1	-30P	-	-30PH		3	-60V	-
	1.5	-12R	-12RG	-	M30	1.5	-30R	-	-30RH				
M13	1.5	-13R	-	-		2	-30T	-30TG	-				
	0.5	-14G	-	-		3	-30V	-	-				
M14	1	-14P	-	-	M31	1.5	-32R	-	-				
	1.25	-14Q	-	-		2	-32T	-	-				
	1.5	-14R	-14RG	-		0.75	-33L	-	-				
M15	0.5	-15G	-	-		1	-33P	-	-				
	1	-15P	-15PG	-15PH	M32	1.5	-33R	-	-				
	1.5	-15R	-15RG	-		2	-33T	-	-				
M16	0.5	-16G	-	-		3	-33V	-	-				
	1	-16P	-	-	M33	1.5	-34R	-	-				
	1.25	-16Q	-	-		2	-34T	-	-				
	1.5	-16R	-	-		1	-36P	-	-				
M17	0.5	-17G	-	-		1.5	-36R	-	-				
	1	-17P	-	-	M36	2	-36T	-	-36TH				
	1.5	-17R	-	-		3	-36V	-	-				
M18	1	-18P	-	-	M37	0.75	-37L	-	-				
	1.5	-18R	-18RG	-									
	2	-18T	-	-									

METRIC THREAD RING GAGES



4120-16



4120-16N

- Standard ISO1502
- Supplied with manufacturer inspection certificate

Code example:
"-2" stands for "4120-2"

Size (mm)		Code (4120)					
		Class 6g		Class 6e		Class 6h	
Nominal diameter	Pitch	GO	NOGO	GO	NOGO	GO	NOGO
M2	0.4	-2	-	-	-	-2H	-2HN
M2.2	0.45	-2D2	-2D2N	-	-	-	-
M2.5	0.45	-2D5	-	-	-	-2D5H	-
M2.6	0.45	-2D6	-	-	-	-	-
M3	0.5	-3	-3N	-	-	-3H	-3HN
M3.5	0.6	-3D5	-3D5N	-	-	-	-
M4	0.7	-4	-	-4E	-4EN	-4H	-4HN
M5	0.8	-5	-5N	-5E	-	-5H	-5HN
M6	1	-6	-6N	-6E	-6EN	-6H	-6HN
M7	1	-7	-7N	-	-	-	-
M8	1.25	-8	-8N	-8E	-8EN	-8H	-
M9	1.25	-9	-9N	-9E	-	-	-
M10	1.5	-10	-10N	-10E	-10EN	-10H	-10HN
M11	1.5	-11	-11N	-	-	-	-
M12	1.75	-12	-12N	-12E	-12EN	-12H	-
M14	2	-14	-14N	-	-	-14H	-
M16	2	-16	-16N	-16E	-16EN	-16H	-
M18	2.5	-18	-18N	-	-	-	-
M20	2.5	-20	-20N	-20E	-20EN	-20H	-20HN
M22	2.5	-22	-22N	-	-	-	-
M24	3	-24	-24N	-	-	-	-
M27	3	-27	-	-	-	-27H	-
M30	3.5	-30	-30N	-	-	-30H	-
M33	3.5	-33	-33N	-	-	-	-
M36	4	-36	-36N	-	-	-36H	-36HN
M39	4	-39	-39N	-	-	-	-
M42	4.5	-42	-42N	-	-	-	-
M45	4.5	-45	-45N	-	-	-	-
M48	5	-48	-48N	-	-	-	-
M56	5.5	-56	-56N	-	-	-	-

Go ring gage set (class 6g)

Code	Thread ring gages included
4120-S7	M3x0.5 (4120-3), M4x0.7 (4120-4), M5x0.8 (4120-5), M6x1 (4120-6), M8x1.25 (4120-8), M10x1.5 (4120-10), M12x1.75 (4120-12)

No Go ring gage set (class 6g)

Code	Thread ring gages included
4120-S7N	M3x0.5 (4120-3N), M4x0.7 (4120-4N), M5x0.8 (4120-5N), M6x1 (4120-6N), M8x1.25 (4120-8N), M10x1.5 (4120-10N), M12x1.75 (4120-12N)

METRIC FINE THREAD RING GAGES



4129-9P



4129-9PN

Code example:
"-2D5D" stands for "4129-2D5D"

- Standard ISO1502
- Supplied with manufacturer inspection certificate

Size (mm)		Code (4129)					
Nominal diameter	Pitch	Class 6g		Class 6e		Class 6h	
		GO	NOGO	GO	NOGO	GO	NOGO
M3	0.35	-3D	-3DN	-	-	-3DH	-3DHN
M3.5	0.35	-3D5D	-3D5DN	-	-	-	-
M4	0.5	-4G	-4GN	-	-	-4GH	4GHN
M4.5	0.5	-4D5G	-4D5GN	-4D5GE	-	-	-
M5	0.5	-5G	-	-	-	-5GH	-
M6	0.5	-6G	-6GN	-	-	-	-
	0.75	-6L	-6LN	-	-	-6LH	-6LHN
M7	0.5	-7G	-7GN	-	-	-	-
	0.75	-7L	-7LN	-7LE	-7LEN	-	-
M8	0.5	-8G	-8GN	-	-	-	-
	0.75	-8L	-8LN	-	-	-	-
	1	-8P	-8PN	-8PE	-8PEN	-8PH	-8PHN
M9	0.5	-9G	-9GN	-	-	-	-
	0.75	-9L	-9LN	-	-	-	-
1	-9P	-9PN	-	-	-9PH	-	
M19	1.5	-19R	-19RN	-	-	-	-
M20	0.5	-20G	-20GN	-	-	-	-
	0.75	-20L	-20LN	-	-	-	-
	1	-20P	-20PN	-20PE	-20PEN	-20PH	-
	1.25	-20Q	-	-	-	-20QH	-20QHN
	1.5	-20R	-20RN	-20RE	-20REN	-	-
M21	2	-20T	-20TN	-	-	-	-
	1	-21P	-21PN	-	-	-	-
	0.75	-22L	-22LN	-	-	-	-
M22	1	-22P	-22PN	-22PE	-22PEN	-	-
	1.5	-22R	-22RN	-22RE	-22REN	-22RH	-22RHN
	2	-22T	-22TN	-	-	-22TH	-
M23	1	-23P	-23PN	-	-	-	-
M24	0.75	-24L	-24LN	-	-	-	-
	1	-24P	-24PN	-	-	-24PH	-24PHN
	1.25	-24Q	-24QN	-	-	-	-
M25	1.5	-24R	-24RN	-	-	-	-
	2	-24T	-	-	-	-24TH	-
	1	-25P	-25PN	-	-	-	-
M26	1.5	-25R	-25RN	-	-	-25RH	-
	2	-25T	-25TN	-	-	-	-
	1	-26P	-26PN	-	-	-	-
M27	1.5	-26R	-26RN	-26RE	-	-	-
	2	-26T	-26TN	-	-	-	-
	0.75	-27L	-27LN	-	-	-	-
M28	1	-27P	-27PN	-	-	-27PH	-
	1.5	-27R	-27RN	-	-	-27RH	-27RHN
	2	-27T	-27TN	-	-	-27TH	-
M28	1	-28P	-28PN	-	-	-	-
	1.5	-28R	-28RN	-	-28REN	-	-
	2	-28T	-	-	-	-28TH	-28THN

Size (mm)		Code (4129)				
Nominal diameter	Pitch	Class 6g	Class 6e	Class 6h		
		GO	NOGO	GO	GO	NOGO
M30	0.75	-30L	-30LN	-	-	-
	1	-30P	-30PN	-	-30PH	-30PHN
	1.5	-30R	-30RN	-	-30RH	-30RHN
	2	-30T	-30TN	-	-30TH	-30THN
M32	3	-30V	-30VN	-	-	-
	1	-32P	-32PN	-	-	-
	1.5	-32R	-32RN	-	-	-
	2	-32T	-32TN	-	-	-
M33	0.75	-33L	-33LN	-	-	-
	1	-33P	-33PN	-	-	-
	1.5	-33R	-33RN	-	-	-
	2	-33T	-33TN	-	-	-
M34	3	-33V	-33VN	-	-	-
	1	-34P	-	-	-	-
M35	1.5	-34R	-	-	-	-
	1.5	-35R	-35RN	-	-35RH	-
M36	1	-36P	-	-	-	-
	1.5	-36R	-36RN	-	-36RH	-36RHN
	2	-36T	-36TN	-	-36TH	-
	3	-36V	-36VN	-	-	-
M38	1.5	-38R	-38RN	-	-	-
M39	1	-39P	-39PN	-	-	-
	1.5	-39R	-39RN	-	-	-
	2	-39T	-39TN	-	-	-
	3	-39V	-39VN	-	-	-
M40	1.5	-40R	-40RN	-40RE	-40RH	-40RHN
M42	1.5	-42R	-42RN	-	-42RH	-42RHN
	2	-42T	-42TN	-	-42TH	-42THN
	3	-42V	-42VN	-	-	-
M45	1.5	-45R	-45RN	-	-	-
	2	-45T	-45TN	-	-	-
	3	-45V	-45VN	-45VE	-	-
M48	1.5	-48R	-48RN	-	-	-
	2	-48T	-48TN	-	-48TH	-48THN
	3	-48V	-48VN	-	-48VH	-48VHN
M50	1.5	-50R	-	-	-	-
M52	1.5	-52R	-52RN	-	-52RH	-52RHN
	2	-52T	-52TN	-	-52TH	-
	3	-52V	-52VN	-	-52VH	-52VHN
	4	-52X	-52XN	-	-	-
M55	2	-55T	-55TN	-	-	-
M56	1.5	-56R	-56RN	-	-	-
	2	-56T	-	-	-	-
	3	-56V	-	-	-56VH	-56VHN
	4	-56X	-	-	-	-
M58	1.5	-58R	-58RN	-	-58RH	-58RHN
	2	-58T	-	-	-	-
M60	1.5	-60R	-60RN	-	-	-
	2	-60T	-60TN	-	-	-
	3	-60V	-	-	-	-
	4	-60X	-60XN	-	-	-

AMERICAN STANDARD THREAD PLUG GAGES

- Supplied with Go and No-Go gages together
- Standard ANSI/ASME B1.2
- Supplied with manufacturer inspection certificate



4131-102

Size	Code	
	Class 2B	Class 3B
No. 0-80UNF	4131-02	–
No. 1-64UNC	4131-11	–
No. 1-72UNF	4131-12	–
No. 2-56UNC	4131-21	–
No. 3-56UNF	4131-32	–
No. 4-40UNC	4131-41	4131-41B
No. 4-48UNF	4131-42	4131-42B
No. 5-40UNC	4131-51	4131-51B
No. 6-32UNC	4131-61	4131-61B
No. 6-40UNF	4131-62	–
No. 8-32UNC	4131-81	4131-81B
No. 8-36UNF	4131-82	–
No. 10-24UNC	4131-101	–
No. 10-32UNF	4131-102	4131-102B
No. 12-24UNC	4131-121	–
No. 12-28UNF	4131-122	–
1/4-20UNC	4131-1B1	4131-1B1B
1/4-28UNF	4131-1B2	4131-1B2B
1/4-32UNEF	4131-1B3	–

Size	Code	
	Class 2B	Class 3B
5/16-18UNC	4131-5D1	4131-5D1B
5/16-24UNF	4131-5D2	4131-5D2B
5/16-32UNEF	4131-5D3	4131-5D3B
3/8-16UNC	4131-3C1	4131-3C1B
3/8-24UNF	4131-3C2	4131-3C2B
3/8-32UNEF	4131-3C3	–
7/16-14UNC	4131-7D1	4131-7D1B
7/16-20UNF	4131-7D2	4131-7D2B
1/2-13UNC	4131-1A1	4131-1A1B
1/2-20UNF	4131-1A2	–
1/2-28UNEF	4131-1A3	–
9/16-12UNC	4131-9D1	4131-9D1B
9/16-18UNF	4131-9D2	4131-9D2B
9/16-24UNEF	4131-9D3	–
5/8-11UNC	4131-5C1	4131-5C1B
5/8-18UNF	4131-5C2	4131-5C2B
5/8-24UNEF	4131-5C3	–
11/16-16UN	4131-11D516	–
11/16-24UNEF	4131-11D3	–

Size	Code	
	Class 2B	Class 3B
3/4-10UNC	4131-3B1	4131-3B1B
3/4-16UNF	4131-3B2	4131-3B2B
3/4-20UNEF	4131-3B3	4131-3B3B
13/16-16UN	4131-13D516	–
13/16-20UNEF	4131-13D3	–
7/8-9UNC	4131-7C1	4131-7C1B
7/8-14UNF	4131-7C2	–
1-8UNC	4131-2A1	–
1-12UNF	4131-2A2	–
1-14UNS	4131-2A514	–
1-32UN	4131-2A532	–
1 1/16-12UN	4131-1E512	–
1 1/8-7UNC	4131-1F1	4131-1F1B
1 1/8-8UN	4131-1F58	4131-1F58B
1 1/8-12UNF	4131-1F2	–
1 3/16-12UN	4131-3E512	–
1 1/4-7UNC	4131-1G1	–
1 1/4-8UN	4131-1G58	4131-1G58B
1 1/4-12UNF	4131-1G2	–

AMERICAN STANDARD THREAD RING GAGES

- Standard ANSI/ASME B1.2
- Class 2A
- Supplied with manufacturer inspection certificate



4121-1B1

4121-1B1N

Size	Code	
	GO	NOGO
No. 4-40UNC	4121-41	4121-41N
No. 5-40UNC	4121-51	4121-51N
No. 6-32UNC	4121-61	4121-61N
No. 8-32UNC	4121-81	4121-81N
No. 10-32UNF	4121-102	4121-102N
No. 12-24UNC	4121-121	4121-121N
No. 12-28UNF	4121-122	4121-122N
1/4-20UNC	4121-1B1	4121-1B1N
1/4-28UNF	4121-1B2	4121-1B2N
5/16-18UNC	4121-5D1	4121-5D1N
5/16-24UNF	4121-5D2	4121-5D2N
5/16-32UNEF	4121-5D3	4121-5D3N
3/8-16UNC	4121-3C1	4121-3C1N
3/8-24UNF	4121-3C2	4121-3C2N
3/8-32UNEF	4121-3C3	4121-3C3N

Size	Code	
	GO	NOGO
7/16-14UNC	4121-7D1	4121-7D1N
7/16-20UNF	4121-7D2	4121-7D2N
7/16-28UNEF	4121-7D3	4121-7D3N
1/2-13UNC	4121-1A1	4121-1A1N
1/2-20UNF	4121-1A2	4121-1A2N
1/2-28UNEF	4121-1A3	4121-1A3N
9/16-12UNC	4121-9D1	4121-9D1N
9/16-18UNF	4121-9D2	4121-9D2N
5/8-11UNC	4121-5C1	4121-5C1N
5/8-18UNF	4121-5C2	4121-5C2N
11/16-16UN	4121-11D516	4121-11D516N
3/4-10UNC	4121-3B1	4121-3B1N
3/4-16UNF	4121-3B2	4121-3B2N
3/4-20UNEF	4121-3B3	4121-3B3N
13/16-16UN	4121-13D516	4121-13D516N

Size	Code	
	GO	NOGO
7/8-9UNC	4121-7C1	4121-7C1N
7/8-14UNF	4121-7C2	4121-7C2N
7/8-16UN	4121-7C516	4121-7C516N
1-8UNC	4121-2A1	4121-2A1N
1-12UNF	4121-2A2	4121-2A2N
1-14UNS	4121-2A514	4121-2A514N
1-32UN	4121-2A532	4121-2A532N
1 1/8-7UNC	4121-1F1	4121-1F1N
1 1/8-12UNF	4121-1F2	4121-1F2N
1 1/4-7UNC	4121-1G1	4121-1G1N
1 1/4-8UN	4121-1G58	4121-1G58N
1 1/4-12UNF	4121-1G2	4121-1G2N
15/16-12UN	4121-5E512	4121-5E512N

CERAMIC MEASURING BALLS



4190-40D000

- Zirconia material, high strength and hardness, extremely wear resistance and corrosion resistance, good insulation, antistatic and magnetic resistance
- Mirror surface without holes
- Supplied with manufacturer inspection certificate

Individual

Code	Diameter	Accuracy	Roundness
4190-1D000	1.000mm	±2µm	0.5µm
4190-1D200	1.200mm	±2µm	0.5µm
4190-1D300	1.300mm	±2µm	0.5µm
4190-1D340	1.340mm	±2µm	0.5µm
4190-1D500	1.500mm	±2µm	0.5µm
4190-1D588	1.588mm (1/16")	±2µm	0.5µm
4190-1D750	1.750mm	±2µm	0.5µm
4190-2D000	2.000mm	±2µm	0.5µm
4190-2D381	2.381mm (3/32")	±2µm	0.5µm
4190-2D500	2.500mm	±2µm	0.5µm
4190-2D778	2.778mm (7/64")	±2µm	0.5µm
4190-3D000	3.000mm	±2µm	0.5µm
4190-3D175	3.175mm (1/8")	±2µm	0.5µm
4190-3D500	3.500mm	±2µm	0.5µm
4190-3D969	3.969mm (5/32")	±2µm	0.5µm
4190-4D000	4.000mm	±2µm	0.5µm
4190-4D500	4.500mm	±2µm	0.5µm
4190-4D763	4.763mm (3/16")	±2µm	0.5µm
4190-5D000	5.000mm	±2µm	0.5µm
4190-5D556	5.556mm (7/32")	±2µm	0.5µm
4190-5D953	5.953mm (15/64")	±2µm	0.5µm
4190-6D000	6.000mm	±2µm	0.5µm
4190-6D350	6.350mm (1/4")	±2µm	0.5µm
4190-6D500	6.500mm	±2µm	0.5µm
4190-6D747	6.747mm (17/64")	±2µm	0.5µm
4190-7D000	7.000mm	±2µm	0.5µm
4190-7D144	7.144mm (9/32")	±2µm	0.5µm
4190-7D500	7.500mm	±2µm	0.5µm
4190-7D938	7.938mm (5/16")	±2µm	0.5µm
4190-8D000	8.000mm	±2µm	0.5µm
4190-8D731	8.731mm (11/32")	±2µm	0.5µm

Individual

Code	Diameter	Accuracy	Roundness
4190-9D525	9.525mm (3/8")	±2µm	0.5µm
4190-10D000	10.000mm	±2µm	0.5µm
4190-10D318	10.318mm (13/32")	±2µm	0.5µm
4190-11D000	11.000mm	±2µm	0.5µm
4190-11D113	11.113mm (7/16")	±2µm	0.5µm
4190-11D509	11.509mm (29/64")	±2µm	0.5µm
4190-11D906	11.906mm (15/32")	±2µm	0.5µm
4190-12D000	12.000mm	±2µm	0.5µm
4190-12D303	12.303mm (31/64")	±2µm	0.5µm
4190-12D700	12.700mm (1/2")	±2µm	0.5µm
4190-13D000	13.000mm	±2µm	0.6µm
4190-13D494	13.494mm (17/32")	±2µm	0.6µm
4190-14D000	14.000mm	±2µm	0.6µm
4190-14D288	14.288mm (9/16")	±2µm	0.6µm
4190-15D000	15.000mm	±2µm	0.6µm
4190-15D081	15.081mm (19/32")	±2.5µm	0.6µm
4190-15D875	15.875mm (5/8")	±2.5µm	0.6µm
4190-16D000	16.000mm	±2.5µm	0.6µm
4190-16D669	16.669mm (21/32")	±2.5µm	0.6µm
4190-17D462	17.462mm (11/16")	±2.5µm	0.6µm
4190-18D000	18.000mm	±2.5µm	0.6µm
4190-18D256	18.256mm (23/32")	±2.5µm	0.6µm
4190-19D050	19.050mm (3/4")	±2.5µm	0.6µm
4190-19D844	19.844mm (25/32")	±2.5µm	0.6µm
4190-20D000	20.000mm	±2.5µm	0.6µm
4190-22D000	22.000mm	±2.5µm	1µm
4190-22D225	22.225mm (7/8")	±2.5µm	1µm
4190-23D812	23.812mm (15/16")	±2.5µm	1µm
4190-25D000	25.000mm	±2.5µm	1µm
4190-40D000	40.000mm	±2.5µm	1.5µm

Set (25 pairs)

Code	Ceramic balls included (one pair per size)
4190-S25	1, 1.5, 2, 2.5, 3, 3.5, 4, 4.5, 5, 6, 6.5, 7, 7.5, 8, 10, 11, 12, 13, 14, 15, 16, 18, 20, 22, 25mm

WATERPROOF DIGITAL PROTRACTOR (HEAVY DUTY)

ABSOLUTE LEVEL

AUTOMATIC BACKLIGHT

IP54 WATERPROOF

2174-225



Unit: mm

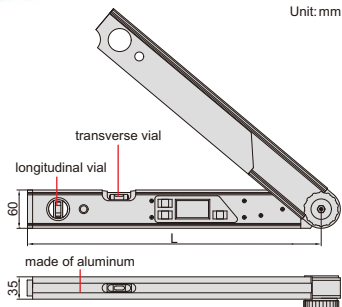
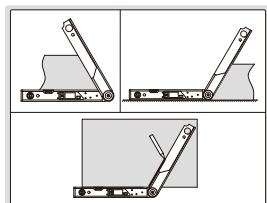

- Suitable for setting horizontal and vertical mitre angles of cutting machine
- Buttons: ON/OFF, HOLD/SUP, SPR/CNR/MTR/BVL
- IP54 dust/waterproof
- With transverse and longitudinal vials
- 2xAAA batteries
- Absolute level, zero setting is not needed when batteries are replaced
- Backlight turns off in one minute after no data changing, automatic power off in 5 minutes

Code	Size (L)	Range	Resolution	Accuracy
2174-225	460mm	0-225°	0.05°	±0.10°

DIGITAL PROTRACTOR



2171-250

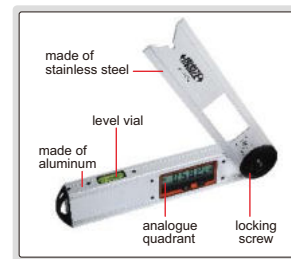
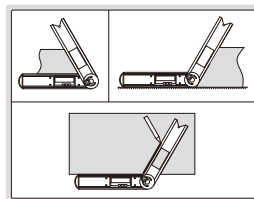
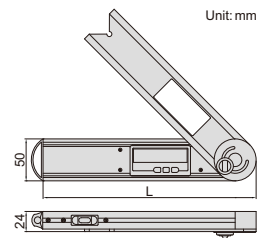

- Buttons: on/off, hold (keep the reading), zero, ABS (absolute and incremental measurement)
- Fix the locking screw at 4 positions for different measuring ranges: 0°~225°, -225°~0°, -45°~180°, -180°~45°
- Remove the locking screw for 360° range
- With level vial
- Battery CR2032
- Automatic power off

Code	Size (L)	Range	Resolution	Accuracy
2171-250	250mm	0-360°	0.05°	±0.15°

DIGITAL PROTRACTORS

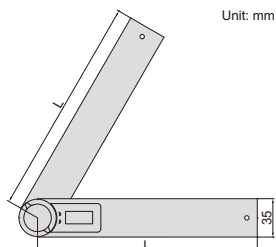

Unit: mm



2176-200

- Resolution: 0.1°
- Buttons: on/off, zero
- With clamping screw to lock the blades
- Graduation of blade: 1mm and 1/32"
- Made of stainless steel
- CR2032 battery, automatic power off

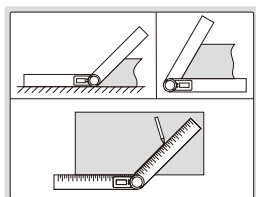

Code	Size (L)	Range	Accuracy
2176-200	200mm	0-360°	±0.3°
2176-300	300mm	0-360°	±0.3°

PROTRACTOR (ECONOMIC TYPE)



4780-85A

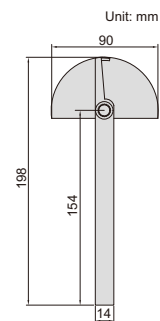

- Made of stainless steel
- With clamping screw

Code	Size	Range	Graduation	Accuracy
4780-85A	90x154mm	0-180°	1°	±0.5°

PROTRACTOR

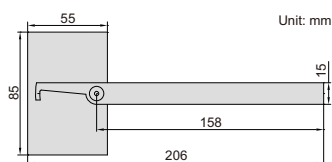

Unit: mm



4781-85A

- Made of stainless steel
- Satin chrome plated scale
- With clamping screw

Code	Size	Range	Graduation	Accuracy
4781-85A	85x158mm	0-180°	1°	±0.3°

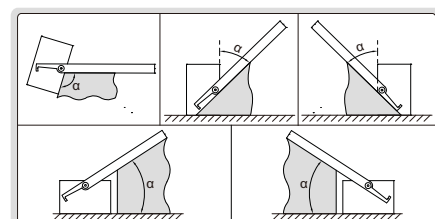

PROTRACTORS



4799-180

- Made of stainless steel (4799-1300 is made of carbon steel)
- Satin chrome plated scale
- With clamping screw

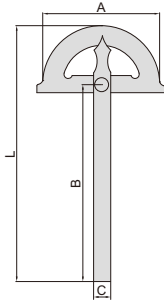

Code	Size (AxB)	Range	Accuracy	Graduation	L	C
4799-180	80x120mm	0-180°	±0.3°	1°	168mm	11mm
4799-1120	120x150mm	0-180°	±0.3°	1°	220mm	14mm
4799-1150	150x200mm	0-180°	±0.3°	1°	285mm	16mm
4799-1200	200x300mm	0-180°	±0.3°	1°	413mm	20mm
4799-1300	300x500mm	0-180°	±0.3°	1°	675mm	30mm

DIGITAL PROTRACTORS

ATTENTION:
NO DATA OUTPUT



4779-120

- Range: 0-180°
- Buttons: on/off, zero, hold/turn
- Made of stainless steel
- With clamping screw

the reading can turn over

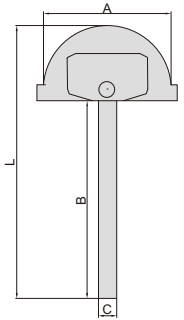

Code	Size (AxB)	Resolution	Accuracy	L	C
4779-120	120x150mm	0.05°	±0.3°	220mm	22mm
4779-150	150x200mm	0.05°	±0.3°	285mm	22mm
4779-200	200x300mm	0.05°	±0.3°	409mm	22mm

PROTRACTORS



4797-100

- Graduation: 1°
- Made of carbon steel
- Satin chrome plated
- With clamping screw
- The blade is moveable

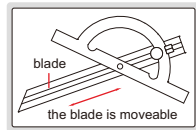
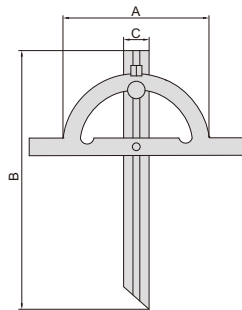

Code	Size (AxB)	Range	Accuracy	C
4797-100	100x150mm	10-170°	±0.3°	18mm
4797-150	150x300mm	10-170°	±0.3°	22mm
4797-200	200x400mm	10-170°	±0.3°	24mm
4797-250	250x500mm	10-170°	±0.3°	28mm
4797-300	300x600mm	10-170°	±0.3°	32mm

DIGITAL PROTRACTORS

ATTENTION:
NO DATA OUTPUT



4778-100

- Range: 0-180°
- Buttons: on/off, zero, hold/turn
- Made of stainless steel
- With clamping screw
- The blade is moveable

the reading can turn over

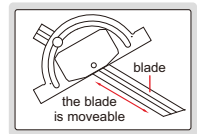
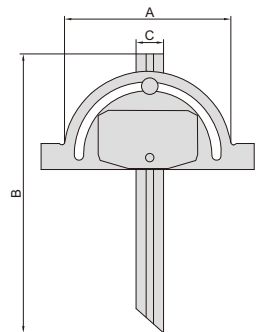

Code	Size (AxB)	Resolution	Accuracy	C
4778-100	100x150mm	0.05°	±0.3°	22mm
4778-150	150x300mm	0.05°	±0.3°	22mm
4778-200	200x400mm	0.05°	±0.3°	24mm

PROTRACTOR

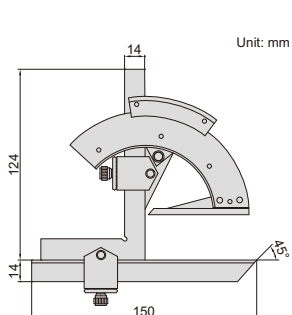

Unit: mm



2374-320

- Made of stainless steel
- Satin chrome plated scale

Code	Range	Graduation	Accuracy
2374-320	0-320°	2'	±2'

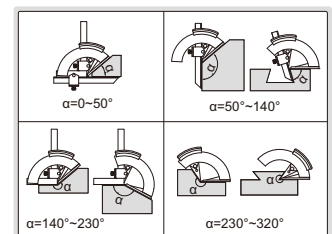

UNIVERSAL PROTRACTOR

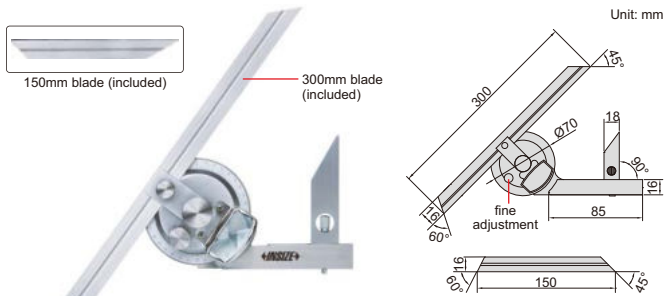

2372-360

- Parallax-free reading
- Made of stainless steel
- Optional accessory: clamp (code **2372-CLAMP**), suitable for height gages **1156, 1150-300, 1351, 1151 and 1250**

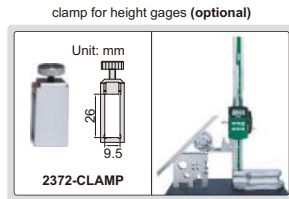

Code	Range	Graduation	Accuracy
2372-360	0-360°	5'	±5'

DIAL PROTRACTOR

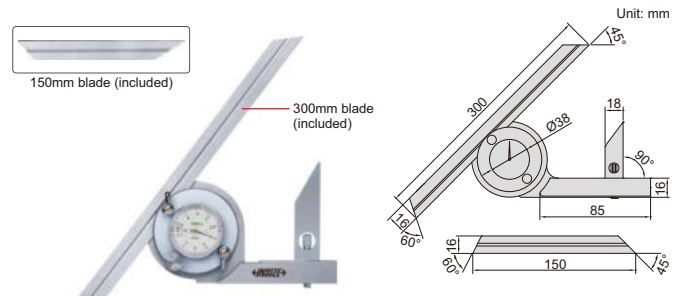

2373-360

- Made of stainless steel
- Optional accessory: clamp (code **2372-CLAMP**), suitable for height gages **1156, 1150-300, 1351, 1151 and 1250**

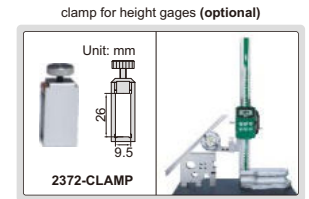

Code	Range	Graduation	Accuracy
2373-360	0-360°	5'	±5'

DIGITAL PROTRACTOR

- Display in degree (for example 32.655°) and degree/minute/second (for example 32°39'30")
- SET button: preset the reading, change measuring direction
- MODE button: choose 0~90°, 0~180° or 0~360° display
- ZERO/ON/OFF button: zero and power on/off
- Battery CR2032, automatic power off
- Data output
- Supplied with square to set 90°
- Made of stainless steel
- Optional accessory: data output cable (code **7315-50, 7302-SPC3B**), clamp (code **2372-CLAMP**), suitable for height gages **1156, 1150-300, 1351, 1151 and 1250**

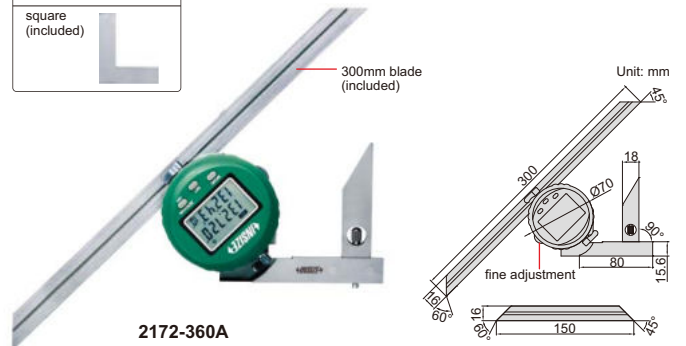
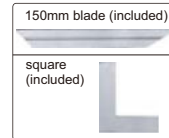
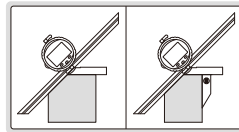

2172-360A

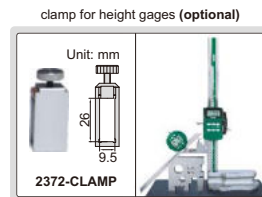

Code	Range	Resolution	Accuracy
2172-360A	0-360°	10"/0.005°	±5'



DATA OUTPUT

DIGITAL PROTRACTOR (BASIC TYPE)

ABSOLUTE ZERO DATA OUTPUT

- Absolute zero, zero setting is not needed when batteries are replaced
- Button function: choose 0~90°, 0~180° or 0~360° display, change resolution, display flips over, data hold, zero, on/off supplementary angle measurement
- Battery CR2032, automatic power off
- Data output
- Made of stainless steel
- Optional square for zero setting
- Optional accessory: clamp (code **2372-CLAMP**), suitable for height gages **1156, 1150-300, 1351, 1250 and 1151**, data output cable (code **7315-2771, 7302-50M**)

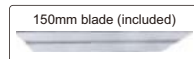

2771-360

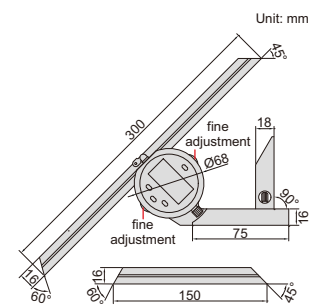

Code	Range	Resolution	Accuracy
2771-360	0-360°	1"/0.01°	±5'

Square (for zero setting, optional)

Code
2771-S90

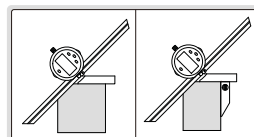

square (optional)

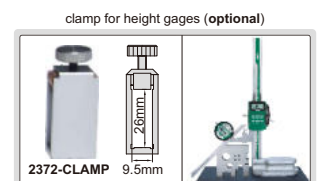
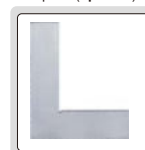

PERPENDICULARITY TESTERS



- Optional accessory: dial test indicators (graduation: 1μm or 2μm)



Code	Range (H)	Perpendicularity (α)	Side perpendicularity (β)	L
4770-300	0-300mm	3μm	10μm	460mm
4770-600	0-600mm	5μm	20μm	760mm



dial test indicator is optional

4770-300

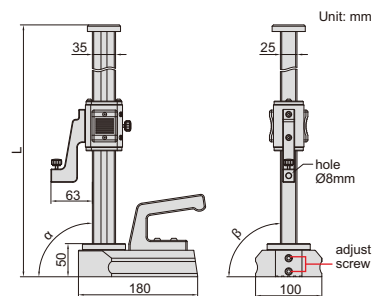

Unit: mm

GRANITE SQUARES

CUSTOM-MADE
SUPPLY SPECIAL SIZES ACCORDING
TO CUSTOMER'S REQUEST



4141-250

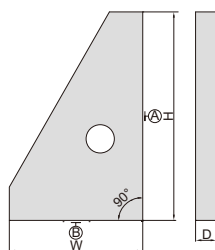

Code	Size (HxW)	Flatness of A	Flatness of B	Squareness of A to B	D
4141-250	250x160mm	1μm	1μm	2μm	25mm
4141-400	400x250mm	1.5μm	1μm	3μm	40mm
4141-630	630x400mm	2μm	1.5μm	4μm	63mm

GRANITE SQUARE WITH V GROOVE



4142-200

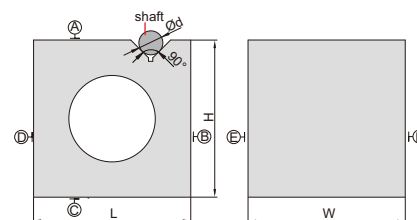

- Parallelism and squareness of A, B, C, D, E and F: 6μm
- Parallelism and squareness of V groove to A, B, C, D, E and F: 6μm

Code	Size (LxWxH)	Range of shaft (Ød)
4142-200	200x200x200mm	9-70mm

90° BEVELED EDGE SQUARES

- Satin chrome plating
- Beveled edges for inside and outside measurement
- Made of hardened stainless steel



4790-0100

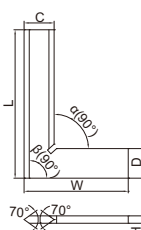

Code	Size (LxW)	Squareness		C	D	H
		Inside (α)	Outside (β)			
4790-050	50x40mm	2.4μm	2.5μm	13	13	4
4790-075	75x50mm	2.6μm	2.8μm	15	15	4
4790-0100	100x70mm	2.8μm	3.0μm	20	20	5
4790-0150	150x100mm	3.2μm	3.5μm	30	30	6
4790-0200	200x130mm	3.7μm	4.0μm	34	34	7
4790-0300	300x200mm	4.6μm	5.0μm	40	40	8

Code	Size (LxW)	Squareness		C	D	H
		Inside (α)	Outside (β)			
4790-500	50x40mm	6μm	6μm	13	13	4
4790-750	75x50mm	6μm	7μm	15	15	4
4790-1000	100x70mm	7μm	7μm	20	20	5
4790-1500	150x100mm	7μm	8μm	30	30	6
4790-2000	200x130mm	8μm	9μm	34	34	7
4790-3000	300x200mm	10μm	11μm	40	40	8

90° FLAT EDGE SQUARES

- Made of hardened stainless steel



4791-100

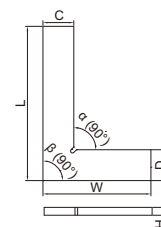

Code	Size (LxW)	Squareness		C	D	H
		Inside (α)	Outside (β)			
4791-50	50x40mm	6μm	6μm	15	15	4
4791-75	75x50mm	6μm	7μm	15	15	4
4791-100	100x70mm	7μm	7μm	20	20	5
4791-150	150x100mm	7μm	8μm	30	30	6
4791-200	200x130mm	8μm	9μm	30	30	7
4791-250	250x165mm	9μm	10μm	35	35	7
4791-300	300x200mm	10μm	11μm	40	40	8

Code	Size (LxW)	Squareness		C	D	H
		Inside (α)	Outside (β)			
4791-501	50x40mm	12μm	13μm	15	15	4
4791-751	75x50mm	13μm	14μm	15	15	4
4791-1001	100x70mm	14μm	15μm	20	20	5
4791-1501	150x100mm	16μm	18μm	30	30	6
4791-2001	200x130mm	19μm	20μm	30	30	6

90° FLAT EDGE SQUARES WITH WIDE BASE

4793-100

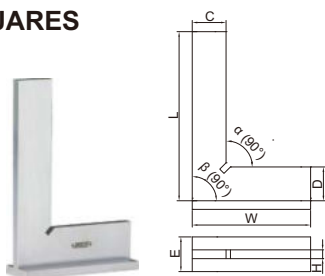

- DIN875 grade 0
- Made of hardened stainless steel

Code	Size (LxW)	Squareness		C	D	H	E
		Inside (α)	Outside (β)				
4793-50	50x40mm	6 μ m	6 μ m	13	13	4	13
4793-75	75x50mm	6 μ m	7 μ m	15	15	4	15
4793-100	100x70mm	7 μ m	7 μ m	20	20	5	20
4793-150	150x100mm	7 μ m	8 μ m	30	30	6	30
4793-200	200x130mm	8 μ m	9 μ m	30	30	7	30
4793-250	250x165mm	9 μ m	10 μ m	35	35	7	35
4793-300	300x200mm	10 μ m	11 μ m	40	40	8	40

(mm)

90° FLAT EDGE SQUARES WITH WIDE BASE



4792-100

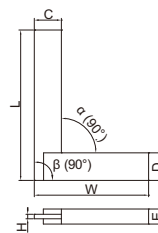

- DIN875 grade 0
- Made of hardened stainless steel

Code	Size (LxW)	Squareness		C	D	H	E
		Inside (α)	Outside (β)				
4792-50	50x40mm	6 μ m	6 μ m	12	12	3	10
4792-75	75x50mm	6 μ m	7 μ m	14	14	3	10
4792-100	100x70mm	7 μ m	7 μ m	18	18	3	10
4792-150	150x100mm	8 μ m	8 μ m	22	22	4	12
4792-200	200x130mm	9 μ m	9 μ m	25	25	4	12

(mm)

MACHINIST SQUARES WITH WIDE BASE (ECONOMIC TYPE)

ATTENTION: NO ANTI-RUST TREATMENT, NOT HARDEND



4707-100

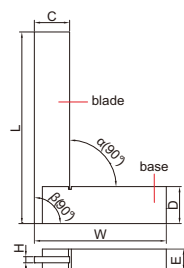

- DIN875 grade 2
- Made of carbon steel, no anti-rust treatment, not hardend

Code	Size (LxW)	Squareness		C	D	H	E
		Inside (α)	Outside (β)				
4707-50	50x40mm	24 μ m	25 μ m	16	12	3	9
4707-75	75x50mm	26 μ m	28 μ m	16	16	3	9
4707-100	100x70mm	28 μ m	30 μ m	19	19	3	12
4707-150	150x100mm	33 μ m	35 μ m	25	25	3	16
4707-200	200x130mm	37 μ m	40 μ m	30	32	4	16
4707-250	250x165mm	42 μ m	45 μ m	30	32	4	19
4707-300	300x200mm	47 μ m	50 μ m	32	32	4	19
4707-400	400x250mm	56 μ m	60 μ m	38	38	5	22
4707-500	500x300mm	65 μ m	70 μ m	45	50	6	25
4707-600	600x350mm	75 μ m	80 μ m	50	50	6	30
4707-750	750x400mm	90 μ m	95 μ m	55	55	6	50
4707-900	900x500mm	103 μ m	110 μ m	65	75	9	50
4707-1000	1000x550mm	113 μ m	120 μ m	65	75	9	50

(mm)

TRY SQUARE

2275-300

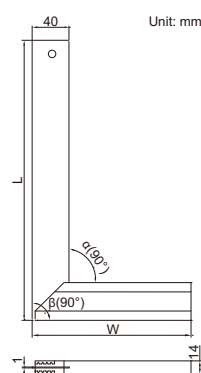

- Graduation: 1mm
- Stainless steel blade, aluminum base

Code	Size (LxW)	Squareness	
		Inside (α)	Outside (β)
2275-300	300x170mm	0.5mm	0.5mm

STRAIGHT EDGES

- DIN874
- Beveled edge
- Made of hardened stainless steel
- Satin chrome plating



4700-100



Code	Size (L)	Straightness	(mm)	
			W	H
4700-100	100mm	2.4 μ m	5	25
4700-150	150mm	2.6 μ m	6	30
4700-200	200mm	2.8 μ m	6	30
4700-300	300mm	3.2 μ m	8	40

45° SQUARES WITH WIDE BASE

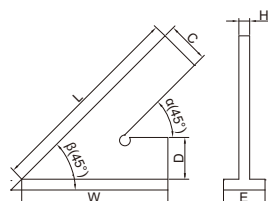

4747-150



- Made of hardened stainless steel

Code	Size (LxW)	Accuracy		C	D	H	E
		Inside (α)	Outside (β)				
4747-150	150x100mm	32 μ m	36 μ m	20	20	5	20
4747-200	200x130mm	36 μ m	41 μ m	25	25	5	25

(mm)

GRANITE STRAIGHT EDGES



4147-500A

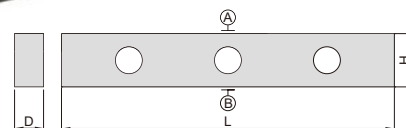

Code	Length (L)	Flatness of A and B	Parallelism between A and B	D	H
4147-500A	500mm	2.1 μ m	3.2 μ m	50mm	80mm
4147-1000A	1000mm	3.0 μ m	4.5 μ m	60mm	120mm

MAGNALIUM STRAIGHT EDGES

LIGHT WEIGHT



4180-1500

- Made of magnalium, light weight, non-deform, no rusty

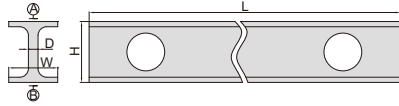

(mm)

Code	Length (L)	Flatness of A and B	Parallelism between A and B	H	W	D	Weight
4180-500	500mm	3µm	4µm	60	30	5	1kg
4180-1000	1000mm	5µm	8µm	60	30	5	1.5kg
4180-1500	1500mm	15µm	22µm	100	40	7	4.5kg
4180-2000	2000mm	18µm	27µm	100	40	7	6kg
4180-3000	3000mm	48µm	72µm	150	80	8	21kg

STRAIGHT EDGES



7111-300A

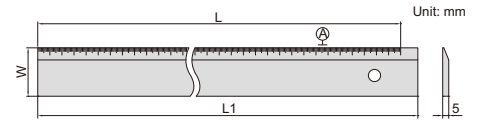
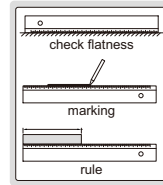

- Check flatness and straightness, as well as for marking
- Graduation on the beveled edge
- Made of hardened tool steel
- Chrome plated

Code	Range (L)	Straightness of A	L1	W
7111-300A	300mm	0.02mm	310mm	40mm
7111-500A	500mm	0.03mm	510mm	40mm

STRAIGHTNESS/FLATNESS GAGE

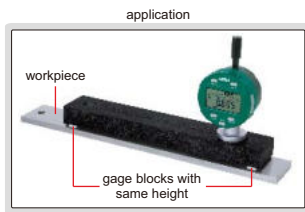

2144-200

- Optional accessory: data output cable (code 7315-50M, 7302-40M)



DATA OUTPUT

GRANITE HOLDER CAN BE CUSTOMIZED ACCORDING TO WORKPIECES

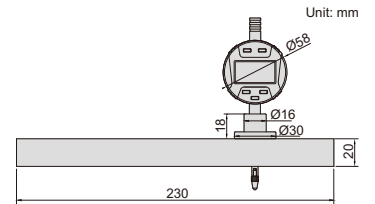

Code	Range	Digital indicator resolution	Straightness measurement accuracy	Parallelism of top and bottom surfaces of granite holder	Flatness of top and bottom surfaces of granite holder
2144-200	200mm	0.001mm/0.00005"	3µm	2µm	1.5µm

FEELER GAGE

- Range: 0.04-1.00mm
- Made of hardened alloy steel
- Meet DIN2275/grade TC1
- Accuracy: $\pm(3+T/80)$ µm, 'T' is the thickness of leaves in µm

Code	Thickness of leaves included (mm)	Quantity of leaves
4601-25	0.04, 0.05, 0.06, 0.07, 0.08, 0.09, 0.10, 0.15, 0.20, 0.25, 0.30, 0.35, 0.40, 0.45, 0.50, 0.55, 0.60, 0.65, 0.70, 0.75, 0.80, 0.85, 0.90, 0.95, 1.00	25



4601-25

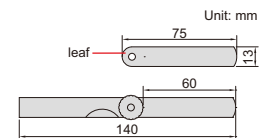

LONG FEELER GAGE

- Range: 0.05-1.00mm
- Made of hardened alloy steel
- Meet DIN2275/grade TC1
- Accuracy: $\pm(3+T/80)$ µm, 'T' is the thickness of leaves in µm



4605-20

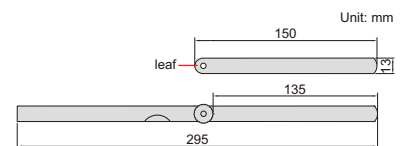

Code	Thickness of leaves included (mm)	Quantity of leaves
4605-20	0.05, 0.10, 0.15, 0.20, 0.25, 0.30, 0.35, 0.40, 0.45, 0.50, 0.55, 0.60, 0.65, 0.70, 0.75, 0.80, 0.85, 0.90, 0.95, 1.00	20

FEELER GAGES

- Made of hardened alloy steel
- Meet DIN2275/grade TC1
- Accuracy: $\pm(3+T/80) \mu\text{m}$,
"T" is the thickness of leaves in μm



4602-20

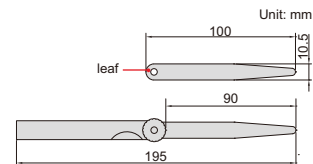

Code	Range	Thickness of leaves included (mm)	Quantity of leaves
4602-13A	0.03-0.50mm	0.03, 0.04, 0.05, 0.06, 0.07, 0.08, 0.09, 0.10, 0.15, 0.20, 0.30, 0.40, 0.50	13
4602-13	0.05-1.00mm	0.05, 0.10, 0.15, 0.20, 0.25, 0.30, 0.40, 0.50, 0.60, 0.70, 0.80, 0.90, 1.00	13
4602-17	0.02-1.00mm	0.02, 0.03, 0.04, 0.05, 0.06, 0.07, 0.08, 0.09, 0.10, 0.15, 0.20, 0.25, 0.30, 0.40, 0.50, 0.75, 1.00	17
4602-20	0.05-1.00mm	0.05, 0.10, 0.15, 0.20, 0.25, 0.30, 0.35, 0.40, 0.45, 0.50, 0.55, 0.60, 0.65, 0.70, 0.75, 0.80, 0.85, 0.90, 0.95, 1.00	20
4602-32	0.03-1.00mm	0.03, 0.04, 0.05, 0.06, 0.07, 0.08, 0.09, 0.10, 0.13, 0.15, 0.18, 0.20, 0.23, 0.25, 0.28, 0.30, 0.33, 0.35, 0.38, 0.40, 0.45, 0.50, 0.55, 0.60, 0.63, 0.65, 0.70, 0.75, 0.80, 0.85, 0.90, 1.00	32

FEELER GAGE TAPES

- Used as shims to accurately set spacing
- Made of hardened alloy steel
- Length 5m
- Width 13mm



4621-30

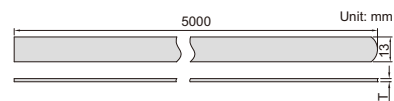

Code	Thickness (T)	Accuracy	Code	Thickness (T)	Accuracy	Code	Thickness (T)	Accuracy
4621-02	0.02mm	$\pm 4\mu\text{m}$	4621-12	0.12mm	$\pm 5\mu\text{m}$	4621-50	0.50mm	$\pm 14\mu\text{m}$
4621-03	0.03mm	$\pm 4\mu\text{m}$	4621-15	0.15mm	$\pm 6\mu\text{m}$	4621-55	0.55mm	$\pm 14\mu\text{m}$
4621-04	0.04mm	$\pm 4\mu\text{m}$	4621-18	0.18mm	$\pm 7\mu\text{m}$	4621-60	0.60mm	$\pm 14\mu\text{m}$
4621-05	0.05mm	$\pm 4\mu\text{m}$	4621-20	0.20mm	$\pm 8\mu\text{m}$	4621-65	0.65mm	$\pm 14\mu\text{m}$
4621-06	0.06mm	$\pm 4\mu\text{m}$	4621-25	0.25mm	$\pm 9\mu\text{m}$	4621-70	0.70mm	$\pm 17\mu\text{m}$
4621-07	0.07mm	$\pm 5\mu\text{m}$	4621-30	0.30mm	$\pm 9\mu\text{m}$	4621-75	0.75mm	$\pm 17\mu\text{m}$
4621-08	0.08mm	$\pm 5\mu\text{m}$	4621-35	0.35mm	$\pm 11\mu\text{m}$	4621-80	0.80mm	$\pm 19\mu\text{m}$
4621-09	0.09mm	$\pm 5\mu\text{m}$	4621-40	0.40mm	$\pm 12\mu\text{m}$	4621-90	0.90mm	$\pm 22\mu\text{m}$
4621-10	0.10mm	$\pm 5\mu\text{m}$	4621-45	0.45mm	$\pm 12\mu\text{m}$			

GEAR TOOTH PITCH GAGES

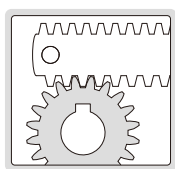

4860-245

- Accuracy: $\pm 0.05\text{mm}$
- Check the module pitch of gear tooth
- Made of hardened stainless steel

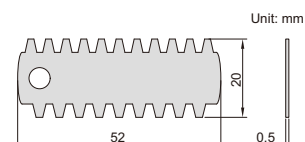

Code	Range	Pressure angle	Quantity of leaves
4860-145	0.35-4.5mm	14.5°	15
4860-245	0.35-4.5mm	20°	15
4860-112	5-12mm	14.5°	8
4860-212	5-12mm	20°	8

PITCH GAGE



4824-12

- Accuracy: $\pm 0.07\text{mm}$
- Check the pitch of screw thread
- Made of medium carbon steel

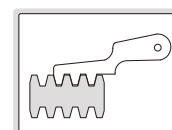

Code	Range	Thread type	Pitch of leaves included	Quantity of leaves
4824-12	2-20mm	Tr30°	2, 3, 4, 5, 6, 7, 8, 9, 10, 12, 16, 20mm	12

PITCH GAGES

- Identify the pitch of screw thread
- Made of medium carbon steel

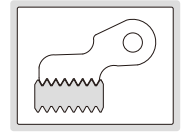

4820-124

Metric 60° screw

Code	Range	Pitch of leaves included	Quantity of leaves
4820-124	0.25-7mm	0.25, 0.3, 0.35, 0.4, 0.5, 0.7, 0.75, 0.8, 0.9, 1, 1.25, 1.5, 1.75, 2, 2.5, 3, 3.5, 4, 4.5, 5, 5.5, 6, 6.5, 7mm	24

Unified 60° screw

Code	Range	Pitch of leaves included	Quantity of leaves
4820-230	4-42TPI	4, 4-1/2, 5, 5-1/2, 6, 7, 8, 9, 10, 11, 11-1/2, 12, 13, 14, 15, 16, 18, 20, 22, 24, 26, 27, 28, 30, 32, 34, 36, 38, 40, 42TPI	30

Metric 60° and Whitworth 55° screw

Code	Range	Pitch of leaves included	Quantity of leaves
4820-452	0.25-6mm	0.25, 0.3, 0.35, 0.4, 0.45, 0.5, 0.6, 0.7, 0.75, 0.8, 0.9, 1, 1.25, 1.5, 1.75, 2, 2.5, 3, 3.5, 4, 4.5, 5, 5.5, 6mm	52
	4-62TPI	4, 4-1/2, 5, 6, 7, 8, 9, 10, 11, 12, 13, 14, 16, 18, 19, 20, 22, 24, 25, 26, 28, 30, 32, 36, 40, 48, 60, 62TPI	

Metric 60° and Unified 60° screw

Code	Range	Pitch of leaves included	Quantity of leaves
4820-552	0.4-7mm	0.4, 0.5, 0.6, 0.7, 0.75, 0.8, 0.9, 1, 1.25, 1.5, 1.75, 2, 2.5, 3, 3.5, 4, 4.5, 5, 5.5, 6, 6.5, 7mm	52
	4-42TPI	4, 4-1/2, 5, 5-1/2, 6, 7, 8, 9, 10, 11, 11-1/2, 12, 13, 14, 15, 16, 18, 20, 22, 24, 26, 27, 28, 30, 32, 34, 36, 38, 40, 42TPI	

CENTER GAGES

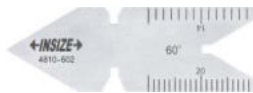

4810-601

- To check and set screw cutting tools, and check the angle and pitch of screw thread
- Angle accuracy: ± 30 min.
- Made of stainless steel

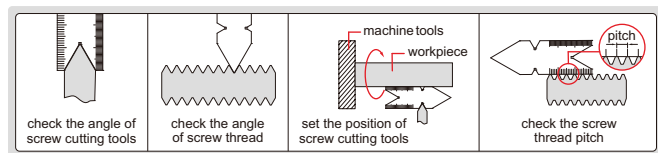
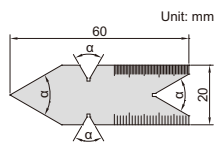

Code	Thread type	Angle (α)	Graduation
4810-601	METRIC 60°	60°	0.5mm and 1mm
4810-55	WHITWORTH 55°	55°	14ths and 20ths on front side, 24ths and 32ths on back side

THREAD GAGES



4812-E

- To check and set screw cutting tools
- Made of medium carbon steel

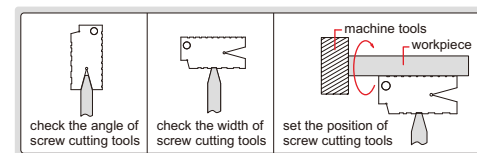
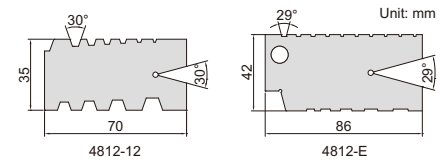

Code	Range	Thread type	Pitch
4812-12	2-12mm	Tr 30°	2, 3, 4, 5, 6, 7, 8, 9, 10, 12mm
4812-E	1-10TPI	ACME 29°	1, 1-1/3, 1-1/2, 1-3/4, 2, 2-1/2, 3, 4, 5, 6, 7, 8, 9, 10TPI

RADIUS GAGES

- Made of carbon steel



4801-17

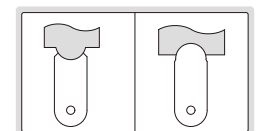

Code	Range	Radius of leaves included (mm)	Quantity of leaves (internal+external)
4801-17	1-7mm	1, 1.25, 1.5, 1.75, 2, 2.25, 2.5, 2.75, 3, 3.5, 4, 4.5, 5, 5.5, 6, 6.5, 7	17+17
4801-16	7.5-15mm	7.5, 8, 8.5, 9, 9.5, 10, 10.5, 11, 11.5, 12, 12.5, 13, 13.5, 14, 14.5, 15	16+16
4801-15	15.5-25mm	15.5, 16, 16.5, 17, 17.5, 18, 18.5, 19, 19.5, 20, 21, 22, 23, 24, 25	15+15

RADIUS GAGE

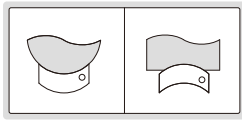

4802-31

- Made of stainless steel

Code	Range	Radius of leaves included (mm)	Quantity of leaves
4802-31	25-40mm	25, 25.5, 26, 26.5, 27, 27.5, 28, 28.5, 29, 29.5, 30, 30.5, 31, 31.5, 32, 32.5, 33, 33.5, 34, 34.5, 35, 35.5, 36, 36.5, 37, 37.5, 38, 38.5, 39, 39.5, 40	31 pcs

CHAMFER GAGE

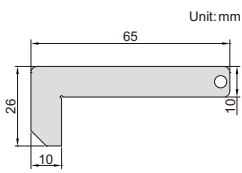

Unit: mm



4844-1

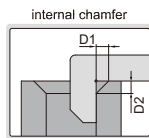
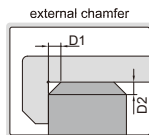

- Accuracy: ± 0.25 mm
- To measure internal and external chamfers
- Made of stainless steel

for internal chamfer measurement, diameter should be larger than 11mm

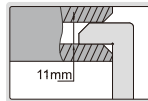

Code	Graduation
4844-1	0.5mm

RADIUS GAGE SET



use of handle

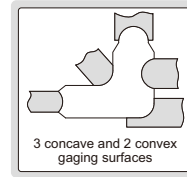

3 concave and 2 convex gaging surfaces



4804-26

- Each piece has 3 concave and 2 convex gaging surfaces
- Supplied with handle
- Made of medium carbon steel

Code	Range	Radius of leaves included (mm)	Quantity of leaves
4804-26	0.5-13mm	0.5, 1, 1.5, 2, 2.5, 3, 3.5, 4, 4.5, 5, 5.5, 6, 6.5, 7, 7.5, 8, 8.5, 9, 9.5, 10, 10.5, 11, 11.5, 12, 12.5, 13	26

CHAMFER GAGES

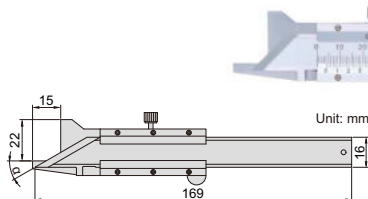

Unit: mm

1267-6



- Measure 30°/45°/60° chamfer dimension
- Accuracy: ± 0.06 mm
- Graduation: 0.02mm
- Made of stainless steel
- Satin chrome plated reading surface

for internal chamfer measurement, diameter should be larger than $\varnothing D$

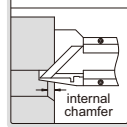
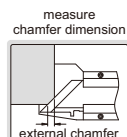
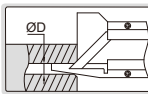

Code	Range	Chamfer (α)	$\varnothing D$
1267-6	0-10mm	45°	7mm
1267-63	0-10mm	30°	8mm
1267-66	0-10mm	60°	7mm

DIGITAL CHAMFER GAGES

DATA OUTPUT



1180-6

for internal chamfer measurement, diameter should be larger than $\varnothing D$

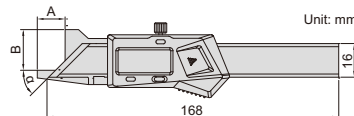
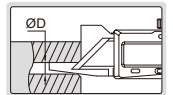

Unit: mm

- Measure 30°/45°/60° chamfer dimension
- Resolution: 0.01mm/0.0005"
- Buttons: on/off, zero, mm/inch
- Automatic power off, move the digital unit to turn on power
- Battery CR2032, data output
- Made of stainless steel
- Optional accessory: data output cable (code 7315-21, 7302-21)

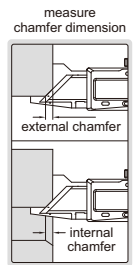
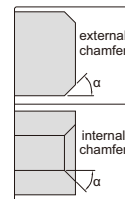

Code	Range	Accuracy	Chamfer (α)	A	B	$\varnothing D$
1180-6	0-10mm/0-0.39"	± 0.06 mm	45°	15mm	22mm	7mm
1180-63	0-10mm/0-0.39"	± 0.06 mm	30°	15mm	22mm	8mm
1180-66	0-10mm/0-0.39"	± 0.06 mm	60°	14mm	21mm	7mm

DIGITAL CHAMFER GAGES



DATA OUTPUT

ATTENTION: THE ACTUAL LENGTH IS 1.414 TIMES OF THE READING

ATTENTION: CHAMFER OF HOLES CANNOT BE MEASURED

- Measure 45° chamfer length
- Resolution: 0.01mm/0.0005"
- Buttons: on/off, set, mm/inch, preset (+, -)
- Automatic power off, move the digital unit to turn on power
- Battery CR2032
- Data output
- Made of stainless steel
- Supplied with pin gage for zero setting

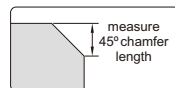

1537-8 can measure small workpieces or workpieces with steps

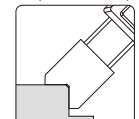

pin gage (included)



Code	Range	Accuracy
1537-20	0-20mm/0-0.787"	± 0.05 mm
1537-8	0-8mm/0-0.315"	± 0.05 mm



1537-20

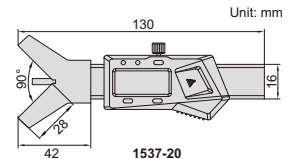

1537-20



1537-8

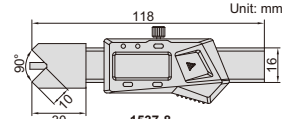

1537-8

DIGITAL TAPER SLOT GAGE

ATTENTION: ACTUAL SLOT WIDTH IS 1/10 OF THE READING

DATA OUTPUT



1160-10

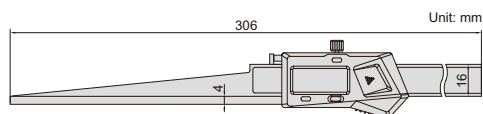

- Measuring opening, slot width
- Resolution: 0.01mm/0.0005"
- Accuracy: ±0.03mm
- Buttons: on/off, zero, mm/inch
- Automatic power off, move the digital unit to turn on power
- Battery CR2032, data output
- Made of stainless steel
- Optional accessory: data output cable (code 7315-21, 7302-21)

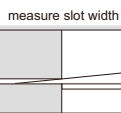

Code	Range
1160-10	0.2-10mm/0.01-0.39"

TAPER SLOT GAGES



4630-1

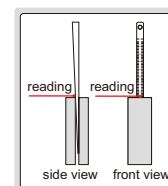

- For quick measurement of slot width
- Satin chrome plated reading surface
- Made of stainless steel

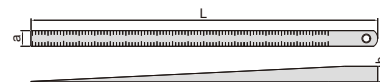

Code	Range	Graduation	Accuracy	L	a	b
4630-3	0.4-6mm	0.05mm	±0.04mm	164	12.5	6.5
4630-1	0.5-10mm	0.05mm	±0.07mm	220	10	10.5
4630-2	0.5-15mm	0.1mm	±0.08mm	184	12.5	16.5

TAPER GAGES

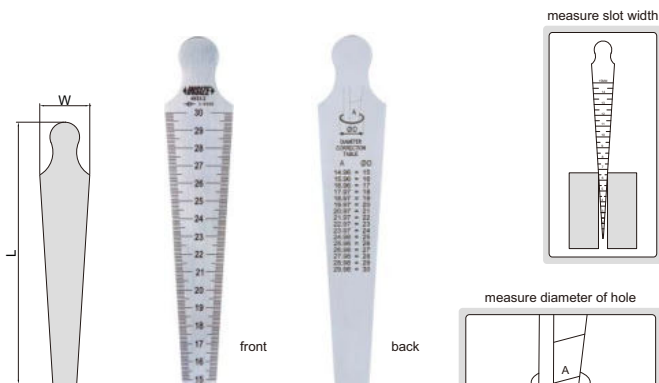

4833-2

- Measure opening, slot width, hole diameter, etc.
- Diameter correction table on the back (only for 4833-1, 4833-2)
- Made of stainless steel

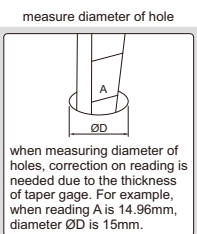

Code	Range	Graduation	Accuracy	L	W
4833-1	0.8-15mm	0.1mm	±0.05mm	146mm	17mm
4833-2	15-30mm	0.1mm	±0.05mm	159mm	30.4mm
4833-3	30-45mm	0.1mm	±0.05mm	166mm	45.4mm
4833-4	45-60mm	0.1mm	±0.05mm	170mm	60.5mm

TAPER GAGE SET



4837-1

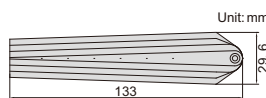

- Include 4pcs (1-8mm, 8-15mm, 15-22mm, 22-29mm)
- Measure opening, slot width, hole diameter, etc.
- Diameter correction table on the back
- Made of stainless steel

Code	Range	Graduation	Accuracy
4837-1	1-29mm	0.05mm	±0.05mm

SMALL TAPER BORE GAGE



4855-5

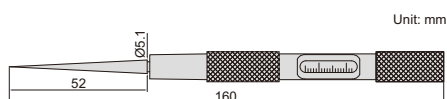

- Quick measurement of small bore diameter
- Hardened working face
- Supplied with protection cap

supplied with protection cap



Code	Range	Graduation	Accuracy
4855-5	0.1-5mm	0.01mm	±0.03mm

TAPER BORE GAGES

- Graduation: 0.1mm
- Accuracy: ±0.05mm
- Quick measurement of bore diameter
- Hardened steel, HRC50-58
- Satin chrome plated surface
- Aluminium oxidized handle

Code	Range	L	Ød1	Ød2
4852-1	1-6.5mm	62.5	7	0.8
4852-3	3-16mm	143	17	2.8
4852-15	15-30mm	165	31	14.7
4852-30	30-45mm	165	46	29.6

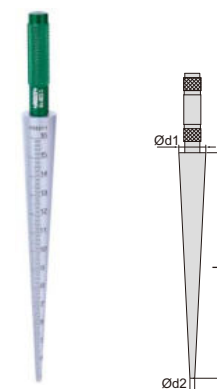

4852-3

WELDING GAGE

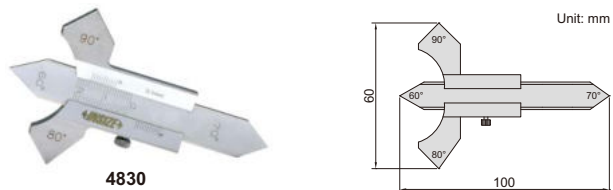

4830

- Made of stainless steel
- Satin chrome plated reading surface

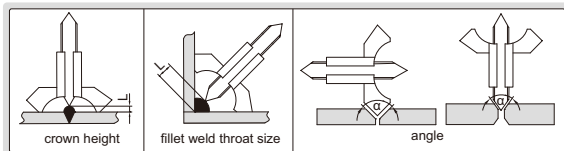

Code	Measurement	Range	Graduation	Accuracy
4830	crown height	0-8mm	0.1mm	±0.1mm
	fillet weld throat size	0-20mm	0.1mm	±0.3mm
	angle	60°, 70°, 80°, 90°	—	±1°

DIGITAL WELDING GAGE

ATTENTION:
NO DATA OUTPUT

- Buttons: zero, mm/inch, on/off
- Battery LR44
- Made of stainless steel

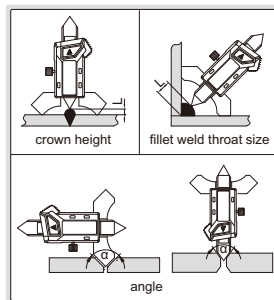

4831-20A

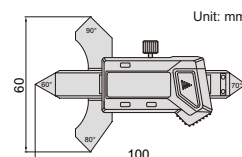

Code	Measurement	Range	Resolution	Accuracy
4831-20A	crown height	0-7mm	0.01mm/0.0005"	±0.03mm
	fillet weld throat size	0-20mm	0.01mm/0.0005"	±0.1mm
	angle	60°, 70°, 80°, 90°	—	±1°

FILLET WELDING GAGE

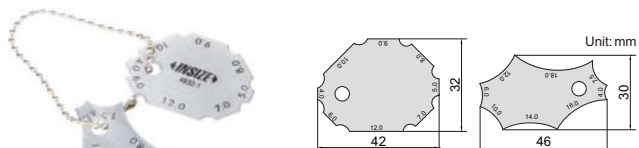

4832-1

- Made of stainless steel
- Sizes marked on both faces

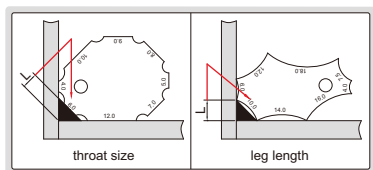

Code	Throat size (mm)	Leg length (mm)	Accuracy
4832-1	4, 5, 6, 7, 8, 9, 10, 12	4, 6, 7.5, 10, 12, 14, 16, 18	±0.5mm

FILLET WELDING GAGE



4836-1

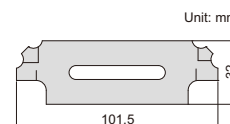

- Measure concave and convex weld sizes
- 7 blades are included
- Made of stainless steel

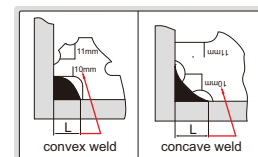

Code	Size (mm)	Accuracy
4836-1	3, 4, 5, 6, 8, 9, 10, 11, 12, 14, 16, 19, 22, 25	±0.5mm

WELDING GAGE



4834-1

- Pointer can be locked for later reference
- Made of stainless steel

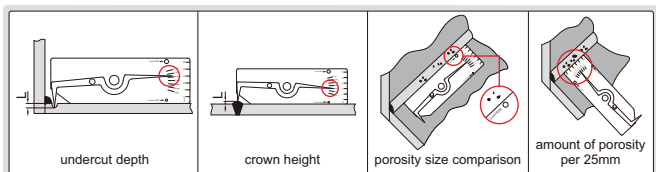

Code	Measurement	Range	Graduation	Accuracy
4834-1	undercut depth	0-6mm	0.5mm	±0.5mm
	crown height	0-6mm	0.5mm	±0.5mm
	porosity size comparison	1.5mm, 3mm	—	±0.2mm
	amount of porosity per 25mm	25mm	1mm	—

WELDING GAGE



4848-1

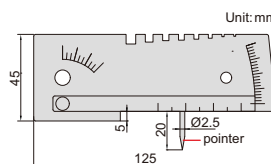

- Made of stainless steel

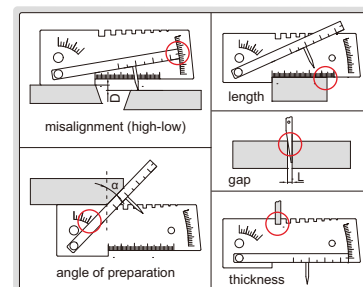

Code	Measurement	Range	Graduation	Accuracy
4848-1	misalignment (high-low)	-5mm~+15mm	1mm	±0.5mm
	angle of preparation	0°-45°	5°	±2.5°
	length	0-50mm	1mm	±0.5mm
	gap	1-4mm	0.5mm	±0.25mm
	thickness	1, 1.2, 2.0, 2.5, 3.0, 3.25, 4.0, 5.0mm	—	±0.1mm

WELDING GAGE

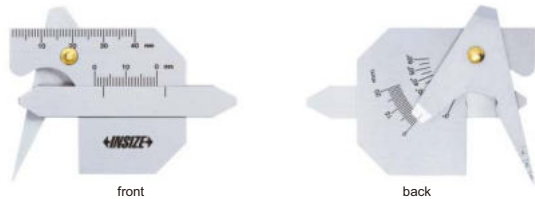

front

back

6832-1

- Made of stainless steel
- Satin chrome plated surface

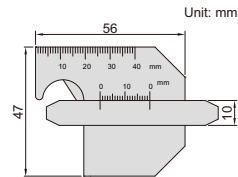

Unit: mm

Code	Measurement	Range	Graduation	Accuracy
6832-1	leg length	0-20mm	1mm	±0.3mm
	leg height	0-20mm	1mm	±0.3mm
	crown height	0-20mm	1mm	±0.3mm
	throat size	0-10mm	1mm	±0.3mm
	angle	0°-60°	5°	±1°
	gap	1-3.5mm	0.5mm	±0.2mm
	length	0-40mm	1mm	±0.3mm

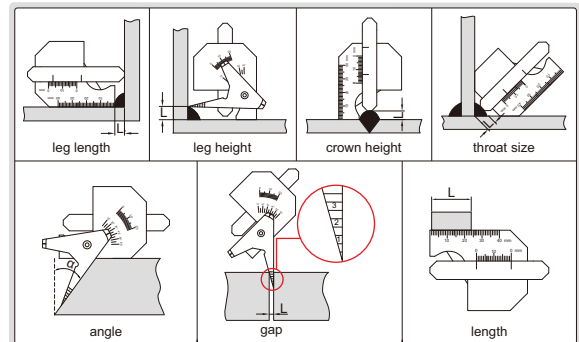

WELDING GAGE



front

back

4835-1

- Adjustable scale to compensate pointer wear
- Made of stainless steel

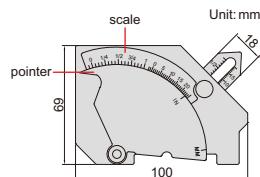

Unit: mm

Code	Measurement	Range	Graduation	Accuracy
4835-1	crown height	0-25mm (0-1")	1mm (1/16")	±0.5mm
	fillet weld leg height	0-25mm (0-1")	1mm (1/16")	±0.5mm
	misalignment (high-low)	0-25mm (0-1")	1mm (1/16")	±0.5mm
	undercut depth	0-2mm (0-1/8")	1mm (1/16")	±0.5mm
	fillet weld throat size	0-20mm (0-3/4")	1mm (1/16")	±0.5mm
	angle of preparation	0-60°	5°	±1°
	length	0-60mm (0-2")	1mm (1/16")	±0.5mm
	45° angle	—	—	±1°

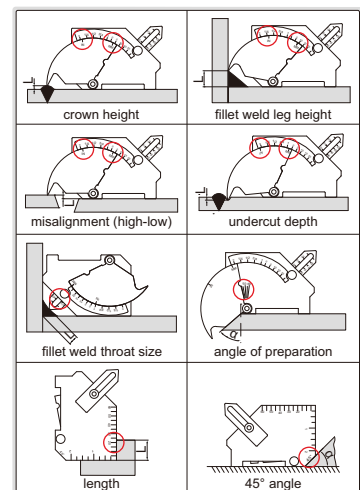

WELDING GAGE

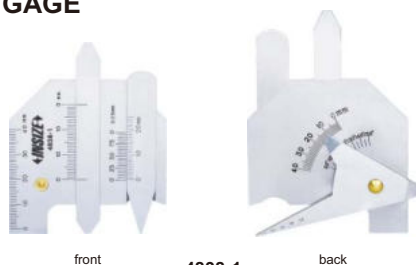

front

back

4838-1

- Made of stainless steel

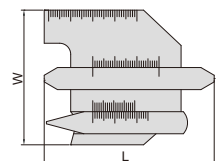

Code	Measurement	Range	Graduation	Accuracy	LxW
4838-1	crown height	0-10mm	1mm	±0.5mm	62x77mm
	leg height	0-14mm	1mm	±0.5mm	
	undercut depth	0-5mm	0.05mm	±0.05mm	
	throat size	0-13mm	1mm	±0.5mm	
	weld length	0-40mm	1mm	±1mm	
	angle	90°-150°	5°	±1°	
	gap	0.5-5mm	1mm	±0.5mm	
	length	0-40mm	1mm	±0.5mm	

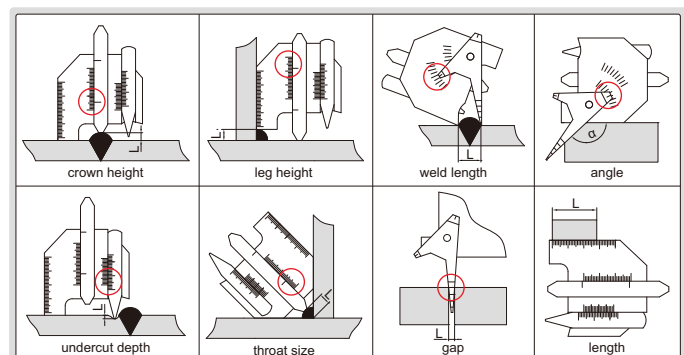

FILLET WELDING GAGE

- Measure convex weld sizes
- 3 blades are included
- Made of stainless steel

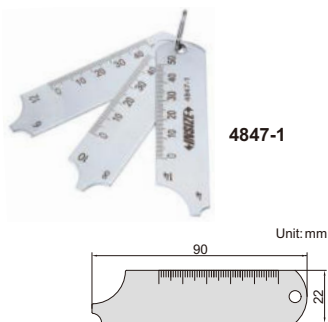
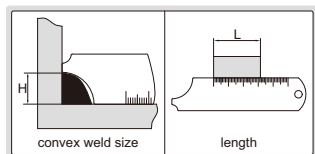

Code	Measurement	Range	Graduation	Accuracy
4847-1	convex weld size	4, 6, 8, 10, 12, 14mm	—	±0.5mm
	length	0-50mm	1mm	±0.5mm

WELDING UNDERCUT GAGE

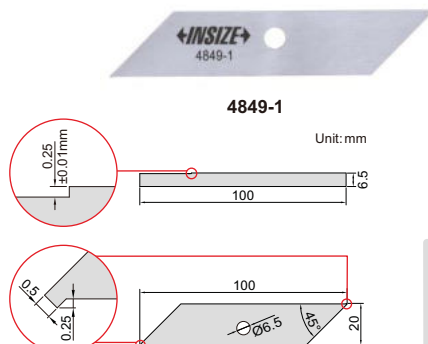

- Measure undercut
- Calibration block is included
- Made of stainless steel

calibration block (included)



application

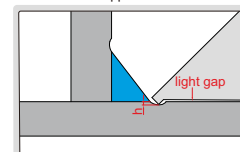

when there is a light gap, $h < 0.25\text{mm}$
when there is no light gap, $h \geq 0.25\text{mm}$

WELDING GAGE

- Made of stainless steel



4850-1

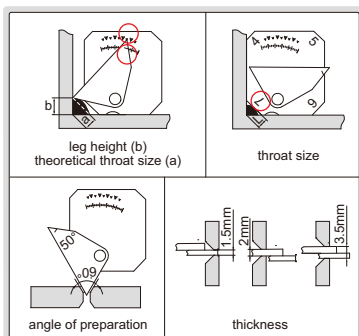
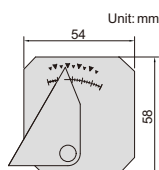

Code	Measurement	Range	Graduation	Accuracy
4850-1	leg height (b)	0-18mm	1mm	±0.5mm
	theoretical throat size (a)	2-12mm	1mm	±0.5mm
	throat size	4, 5, 6, 7mm	—	±0.5mm
	angle of preparation	50°, 60°	—	±1°
	thickness	1.5, 2, 3.5mm	—	±0.2mm

WELDING GAGE



- Made of stainless steel

Code	Graduation	Accuracy
4840-1	0.2mm	±0.3mm

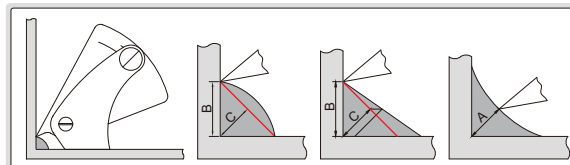

WELDING GAGE

- Accuracy: ±0.5mm
- Made of stainless steel

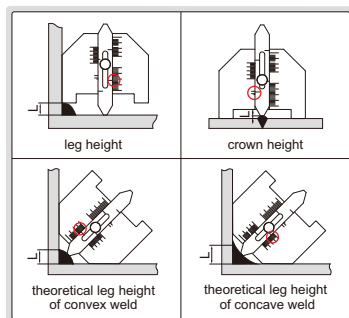

4851-1

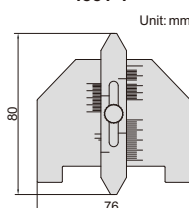

Code	Measurement	Range	Graduation
4851-1	leg height	0-20mm	1mm
	crown height	0-3mm	—
	theoretical leg height of convex weld	0-20mm	1mm
	theoretical leg height of concave weld	0-20mm	1mm

FILLET WELDING GAGE

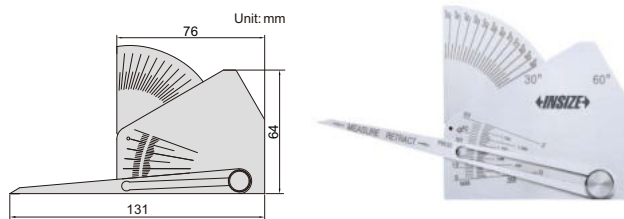

4846-1

- Calculating card is included
- Made of stainless steel

calculating card (included)

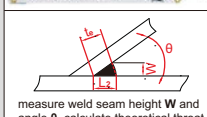
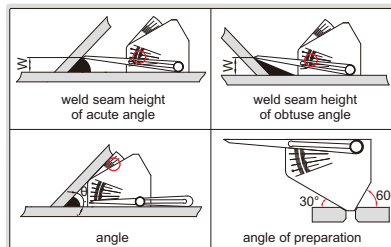

measure weld seam height W and angle θ , calculate theoretical throat size L_z and leg height L_z according to W and θ .

Code	Measurement	Range	Graduation	Accuracy
4846-1	weld seam height W	0-50mm/0-2"	2mm/.050"	±1mm
	angle θ	30°~90°	2.5°	±1°
	60° angle	—	—	±0.5°

PIPE WELDING GAGE

- Made of stainless steel



4839-1

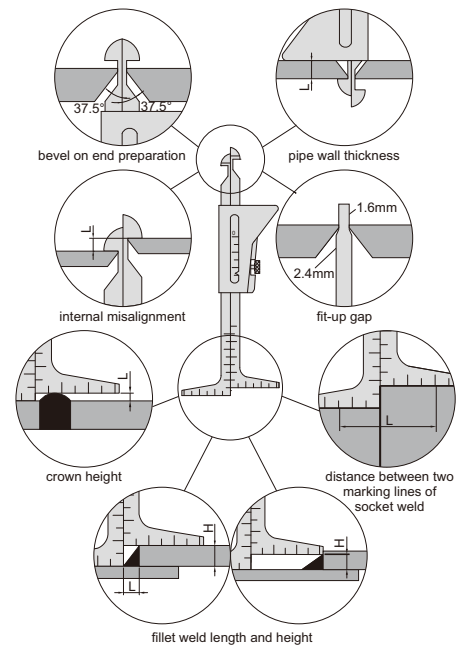
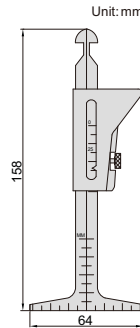

Code	Measurement	Range	Graduation	Accuracy
4839-1	bevel on end preparation	37.5°	—	±1°
	pipe wall thickness	0-45mm (0~1-3/4")	1mm (1/16")	±0.5mm
	internal misalignment	0-35mm (0~1-3/8")	1mm (1/32")	±0.5mm
	fit-up gap	1.6mm, 2.4mm	—	±0.1mm
	crown height	0-35mm (0~1-3/8")	1mm (1/32")	±0.5mm
	distance between two marking lines of socket weld	0-60mm (0~2-3/8")	1mm (1/16")	±0.5mm
	fillet weld length	0-30mm (0~1-1/4")	1mm (1/16")	±0.5mm
	fillet weld height	0-35mm (0~1-3/8")	1mm (1/32")	±0.5mm

PIPE WELDING GAGE

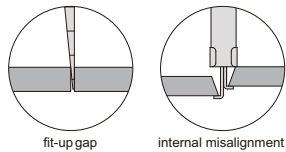

- Made of stainless steel

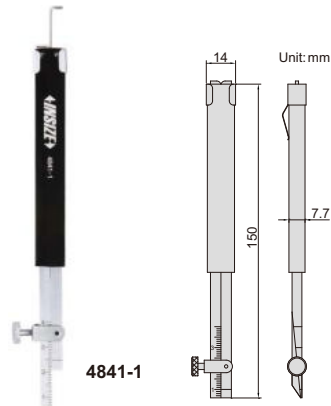

4841-1

Code	Measurement	Range	Graduation	Accuracy
4841-1	internal misalignment	0-30mm	1mm	±0.5mm
	fit-up gap	0.7-4mm	0.1mm	±0.1mm

6-PIECE WELDING GAGE SET

- Includes:
 - 1) Welding gage (code 4834-1)
 - 2) Fillet welding gage, size 3-25mm, 7 blades (code 4836-1)
 - 3) Pipe welding gage (code 4841-1)
 - 4) Telescoping inspection mirror, size of mirror Ø32mm, length 178-505mm (code 7160-1)
 - 5) Pocket rule with sliding clip, range 150mm/6", graduation 1mm, 1/64" (code 7119-150)
 - 6) LED flashlight (code ISGF-0501)



5064

Code
5064

7-PIECE WELDING GAGE SET

- Includes:
 - 1) Welding gage (code 4834-1)
 - 2) Welding gage (code 4851-1)
 - 3) Fillet welding gage, size 3-25mm, 7 blades (code 4836-1)
 - 4) Outside micrometer, range 0-25mm, graduation 0.01mm (code 3203-25A)
 - 5) Digital caliper, range 0-150mm/0-6", resolution 0.01mm/0.005" (code 1108-150)
 - 6) Pocket rule with sliding clip, range 150mm/6", graduation 1mm, 1/64" (code 7119-150)
 - 7) Magnifier with illumination, magnification 4X (code 7513-4)



5072

Code
5072

7-PIECE WELDING GAGE SET

- Includes:
 - 1) Welding gage (code 4834-1)
 - 2) Welding gage (code 4851-1)
 - 3) Pipe welding gage (code 4839-1)
 - 4) Outside micrometer, range 0-25mm, graduation 0.01mm (code 3203-25A)
 - 5) Telescoping inspection mirror, size of mirror Ø32mm, length 178-505mm (code 7160-1)
 - 6) Magnifier with illumination, magnification 4X (code 7513-4)
 - 7) Steel rule, range 150mm/6", graduation 0.5mm, 1mm, 1/64", 1/32", 1/16" (code 7110-150)



5071

Code
5071

AMERICAN STANDARD WIRE GAGE



4808

Unit: mm

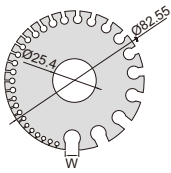

No.	W	No.	W
0	8.250mm/0.3249"	18	1.020mm/0.0403"
1	7.350mm/0.2893"	19	0.912mm/0.0359"
2	6.540mm/0.2576"	20	0.813mm/0.0320"
3	5.830mm/0.2294"	21	0.724mm/0.0285"
4	5.190mm/0.2043"	22	0.643mm/0.0253"
5	4.620mm/0.1819"	23	0.574mm/0.0226"
6	4.110mm/0.1620"	24	0.511mm/0.0201"
7	3.670mm/0.1443"	25	0.440mm/0.0179"
8	3.260mm/0.1285"	26	0.404mm/0.0159"
9	2.910mm/0.1144"	27	0.361mm/0.0142"
10	2.590mm/0.1019"	28	0.320mm/0.0126"
11	2.300mm/0.0907"	29	0.287mm/0.0113"
12	2.050mm/0.0808"	30	0.254mm/0.0100"
13	1.820mm/0.0720"	31	0.226mm/0.0089"
14	1.630mm/0.0641"	32	0.203mm/0.0080"
15	1.450mm/0.0571"	33	0.180mm/0.0071"
16	1.290mm/0.0508"	34	0.160mm/0.0063"
17	1.150mm/0.0453"	35	0.142mm/0.0056"
		36	0.127mm/0.0050"

- For gaging non-ferrous wire and metals such as copper, brass and aluminum
- Hardened to HRC50-57

Code	Range
4808	0-36 (8.250-0.127mm/0.3249-0.0050")

U.S. STANDARD SHEET METAL GAGE

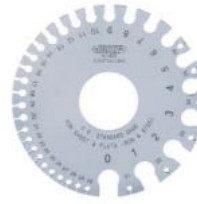

4809

Unit: mm

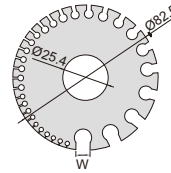

No.	W	No.	W
0	7.938mm/0.3125"	18	1.270mm/0.0500"
1	7.144mm/0.2813"	19	1.111mm/0.0438"
2	6.747mm/0.2656"	20	0.953mm/0.0375"
3	6.350mm/0.2500"	21	0.873mm/0.0344"
4	5.953mm/0.2344"	22	0.794mm/0.0313"
5	5.556mm/0.2188"	23	0.714mm/0.0281"
6	5.159mm/0.2031"	24	0.635mm/0.0250"
7	4.763mm/0.1875"	25	0.556mm/0.0219"
8	4.366mm/0.1719"	26	0.476mm/0.0188"
9	3.969mm/0.1563"	27	0.437mm/0.0172"
10	3.572mm/0.1406"	28	0.397mm/0.0156"
11	3.175mm/0.1250"	29	0.357mm/0.0141"
12	2.778mm/0.1094"	30	0.318mm/0.0125"
13	2.381mm/0.0938"	31	0.278mm/0.0109"
14	1.984mm/0.0781"	32	0.258mm/0.0102"
15	1.786mm/0.0703"	33	0.238mm/0.0094"
16	1.588mm/0.0625"	34	0.218mm/0.0086"
17	1.429mm/0.0563"	35	0.198mm/0.0078"
		36	0.179mm/0.0070"

- For gaging sheet metal, plate iron and steel
- Hardened to HRC50-57

Code	Range
4809	0-36 (7.938-0.179mm/0.3125-0.0070")

WIRE GAGE

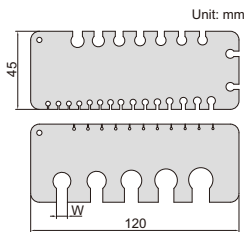

Unit: mm

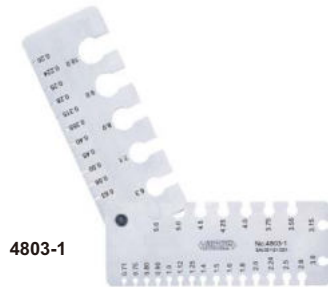

4803-1

wire diameter (W)	wire diameter (W)	wire diameter (W)
0.200mm	0.900mm	3.55mm
0.224mm	1.000mm	3.75mm
0.250mm	1.120mm	4.00mm
0.280mm	1.250mm	4.25mm
0.315mm	1.400mm	4.50mm
0.355mm	1.500mm	5.00mm
0.400mm	1.60mm	5.60mm
0.450mm	1.80mm	6.30mm
0.500mm	2.00mm	7.10mm
0.560mm	2.24mm	8.00mm
0.630mm	2.50mm	9.00mm
0.710mm	2.80mm	10.00mm
0.750mm	3.00mm	
0.800mm	3.15mm	

- For gaging non-ferrous wire and metals such as copper, brass and aluminum
- Hardened to HRC51-53
- Including 2 pcs wire gages

Code	Range
4803-1	0.2-10mm

THICKNESS GAGE



4853-1

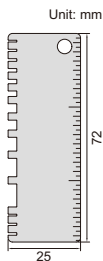

Unit: mm

- Made of stainless steel

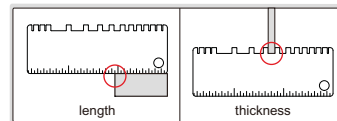

Code	Measurement	Range	Graduation	Accuracy
4853-1	length	0-2 3/4"	1/16"	1/32"
	thickness	24GA. (0.0239"), 22GA. (0.0299"), 20GA. (0.0359")	—	±0.002"
		18GA. (0.0478"), 16GA. (0.0598"), 14GA. (0.0747"), 1/8" (0.125"), 10GA. (0.1345"), 3/16" (0.1875"), 1/4" (0.250"), 5/16" (0.3125")		±0.004"
		0.024", 0.030", 0.035"		±0.002"

DRILL POINT GAGE



4843-1

- For twist drills with 118° angle, to check if the center of tip is concentric with the drill body
- Made of stainless steel

Code	Accuracy	
	Angle	Length
4843-1	±0.5°	±0.5mm

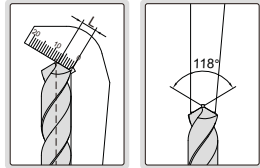

DRILL ANGLE GAGE



4842-1

- Check drills with angle 60°, 70°, 90°, 118°, 125°, 135°, 150° or 160°
- Made of stainless steel

Code	Accuracy
4842-1	±0.5°

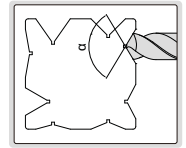

ANGLE GAGE

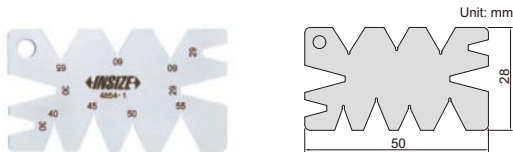

4854-1

- Made of stainless steel

Code	Range	Accuracy
4854-1	29°, 30°, 40°, 45°, 50°, 55°, 60°	±10'

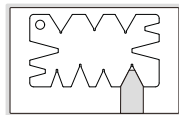

check the angle of screw cutting tools

INSIDE SPRING CALIPERS

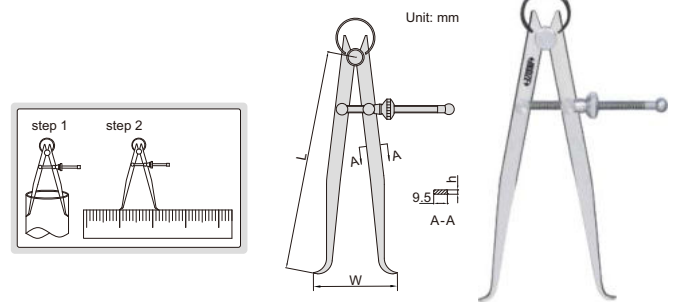

7261-150

- Made of carbon steel

Code	Size (L)	Range (W)	h
7261-150	150mm	17-150mm	2mm
7261-200	200mm	17-200mm	3mm
7261-300	300mm	18-300mm	3mm



OUTSIDE SPRING CALIPERS

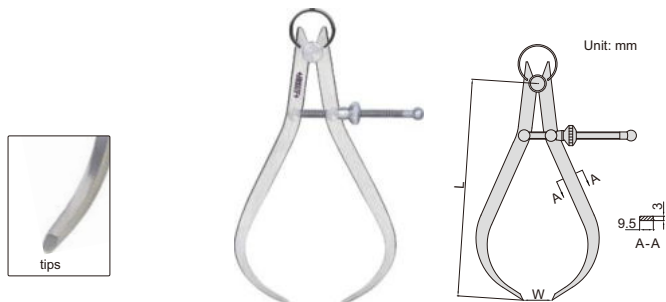

7262-150

- Made of carbon steel

Code	Size (L)	Range (W)
7262-150	155mm	0-140mm
7262-200	210mm	0-210mm
7262-250	265mm	0-270mm
7262-300	310mm	0-320mm

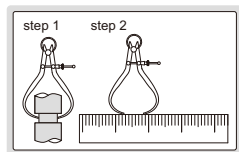

SPRING DIVIDERS

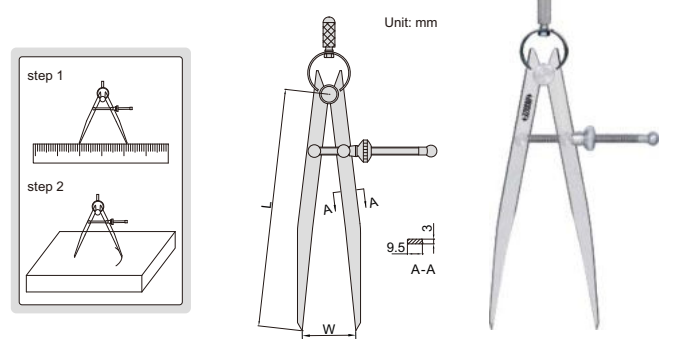

7260-150

Code	Size (L)	Range (W)
7260-150	150mm	0-150mm
7260-200	200mm	0-210mm
7260-250	245mm	0-260mm
7260-300	300mm	0-320mm

- Made of carbon steel
- Hardened points

DIVIDERS

- Made of carbon steel
- Hardened points

Code	Size (L)	Range (W)	(mm)	
			a	b
7247-150	150mm	0-140mm	8.5	7
7247-200	200mm	0-190mm	10	7
7247-300	300mm	0-290mm	12	7

7247-150

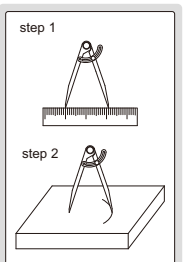
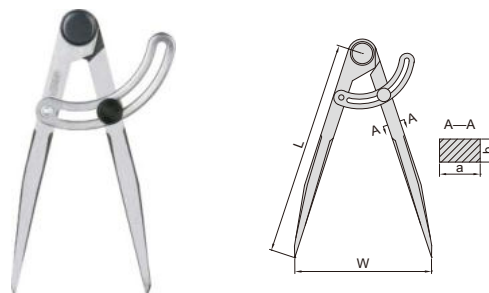

MEASURING TAPES

EG II



7140-5

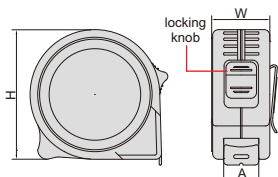
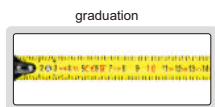

- Non-glare nylon surface for wear resistance

Code	Range	Graduation	Width of tape A	W	H
7140-3	0-3m	1mm	16mm	28mm	62mm
7140-5	0-5m	1mm	19mm	30mm	68mm
7140-8	0-8m	1mm	25mm	38mm	78mm

MEASURING TAPE (BASIC TYPE)

EG II



7142-5

- Non-glare nylon coating tape, wear resistance

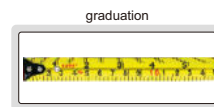
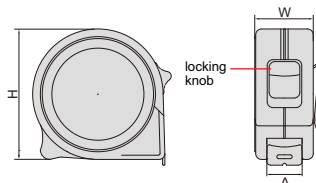

Code	Range	Graduation	Width of tape A	W	H
7142-5	0-5m/0-16ft	1mm, 1/16"	19mm	31mm	64mm

LONG MEASURING TAPE

EG II

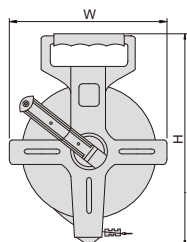

7143-50

- High tensile strength fibreglass tape
- Nylon coating tape, wear resistance

Code	Range	Graduation	Width of tape	W	H
7143-50	0-50m/0-165ft	1mm, 1/8"	13mm	220mm	320mm

MEASURING WHEEL (BASIC TYPE)

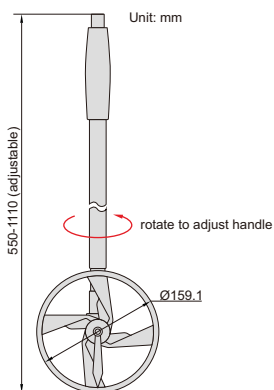

7144-1

- ABS plastic frame, wear-resistant PU tire
- Three-section adjustable handle

Code	Range	Resolution
7144-1	0.1-9999.9m	0.1m

MEASURING WHEEL



after folding



- ABS plastic frame, wear-resistant PU tire
- Two-section foldable handle

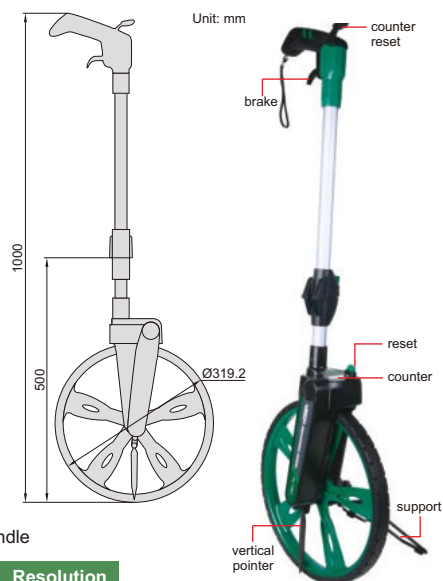

7145-1

Code	Range	Resolution
7145-1	0.1-9999.9m	0.1m

POCKET RULE WITH SLIDING CLIP



7119-150

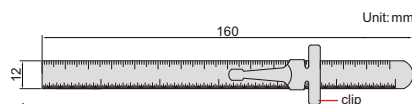

- With sliding clip, clip also can be used as depth gage base
- Inch/metric conversion table on the back
- Made of stainless steel

Code	Range	Graduation	Accuracy
7119-150	150mm/6"	1mm, 1/64"	±0.15mm

STEEL RULES



7110-300

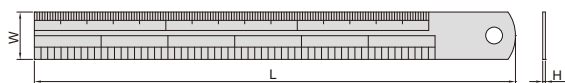

- Graduation: 0.5mm, 1mm, 1/64", 1/32", 1/16"
- Rigid rules
- Made of stainless steel
- Non-glare surface

Code	Range	Accuracy	L	W	H	Remark
7110-150	150mm/6"	±0.18mm	170	18	1.0	graduation on front and back
7110-200	200mm/8"	±0.18mm	220	18	1.0	graduation on front and back
7110-300	300mm/12"	±0.27mm	330	25	1.0	graduation on front and back
7110-3001	300mm/12"	±0.27mm	325	30	1.0	graduation on front and back
7110-500	500mm/20"	±0.27mm	530	30	1.2	graduation on front and back
7110-600	600mm/24"	±0.45mm	630	30	1.2	graduation on front and back
7110-1000	1000mm/40"	±0.45mm	1040	32	1.5	graduation on front and back
7110-1500	1500mm/60"	±0.63mm	1550	38	1.8	graduation on front
7110-2000	2000mm/80"	±0.80mm	2065	40	2.0	graduation on front

ALUMINUM RULES



7123-300

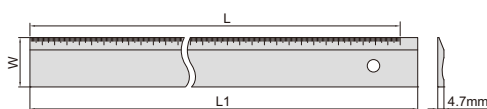

- Made of aluminum, oxidized surface

Code	Range (L)	Accuracy	Graduation	L1	W
7123-300	300mm	±0.5mm	1mm	321mm	50mm
7123-600	600mm	±0.9mm	1mm	624mm	50mm
7123-1000	1000mm	±0.9mm	1mm	1024mm	50mm

MARKING GAGES



7120-200A

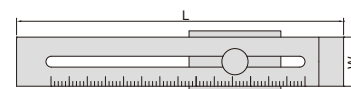
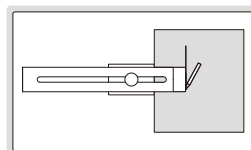

- Made of carbon steel
- Satin chrome plated

Code	Range	Graduation	Accuracy	L	W
7120-200A	0-200mm	0.1mm	±0.1mm	250mm	40mm
7120-250A	0-250mm	0.1mm	±0.1mm	300mm	40mm
7120-300A	0-300mm	0.1mm	±0.1mm	350mm	40mm

T-SHAPE MARKING GAGE



1275-150B

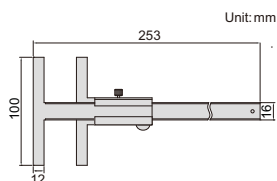
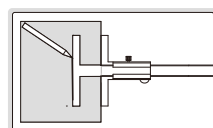

- Made of stainless steel
- Satin chrome plated reading surface

Code	Range	Graduation	Accuracy
1275-150B	0-150mm	0.02mm	±0.04mm

COMBINATION SQUARE (ECONOMIC TYPE)



2276-300

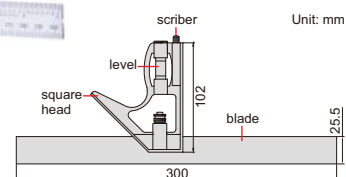

- Square head (made of zinc):
to set the blade at 90° or 45°
to an edge of a workpiece
accuracy: ±0.5°
- Blade (made of stainless steel):
range: 300mm/12",
graduation: 1mm and 1/32" on front
face, 1mm and 1/16" on back face

Code
2276-300

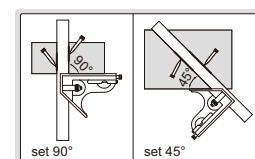

COMBINATION SQUARE SETS

- Center head (made of cast iron): to locate center of cylinder with diameter (Ød): 30-100mm accuracy: ±0.15mm
- Protractor head (made of cast iron): to set the blade at desired angle to an edge of a workpiece and can be used to measure angles range: 0-180°, accuracy: ±20min.
- Square head (made of cast iron): to set the blade at 90° or 45° to an edge of a workpiece accuracy: ±8min for 90° square, ±10min for 45° square
- Blade (made of stainless steel): range: 300mm/12", graduation: 0.5mm and 1/32" on front face, 1mm and 1/64" on back face
- Optional accessory: rigid rule (code 7113)



2278-2



2278-180

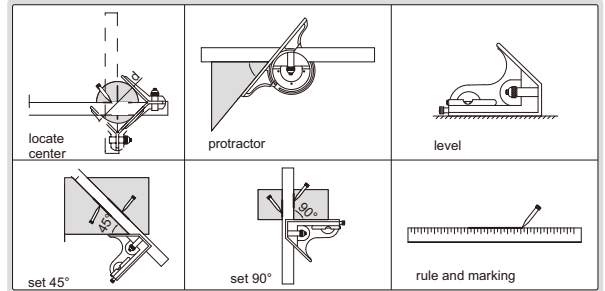
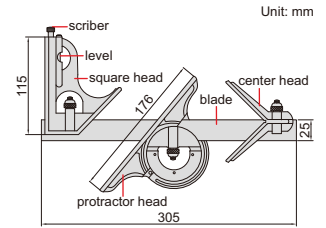

Code	Remark
2278-2	2-piece set
2278-180	4-piece set

CENTER MARKING GAGES



7205-100

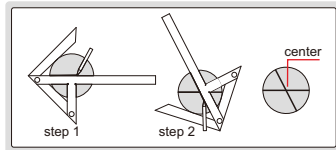
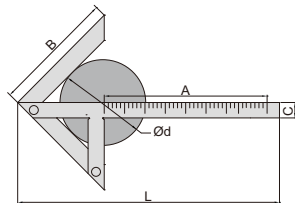

- Accuracy: ±0.15mm
- Marking the center of round plates and shafts
- Made of stainless steel
- Satin chrome plated

Code	Size (AxB)	Diameter of shafts (Ød)	C	L
7205-100	100x70mm	4-90mm	12mm	153mm
7205-150	150x130mm	4-190mm	15mm	245mm
7205-200	200x150mm	6-220mm	15mm	310mm

SCRIBER CALIPER



7202-200A

the position of scribe tip can be adjusted

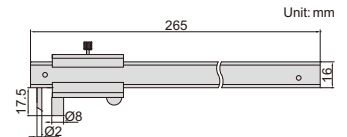
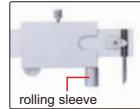

- Graduation: 0.1mm, 1/128"
- Made of stainless steel
- Satin chrome plated reading surface
- Carbide scribe tip
- Optional accessory: carbide scribe tip (code SP-SCRIBER-7202)

Code	Range	Accuracy
7202-200A	0-200mm/0-8"	±0.1mm

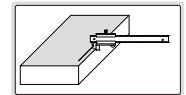

DIGITAL SCRIBING CALIPER

DATA OUTPUT



1166-150A

carbide measuring faces

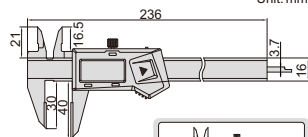

- The carbide-tipped jaws facilitate scribing on workpieces
- Buttons: on/off, zero, mm/inch
- Automatic power off, move the digital unit to turn on power
- Battery CR2032, data output
- Made of stainless steel
- Optional accessory: data output cable (code 7315-21, 7302-21)

Code	Range	Accuracy	Resolution
1166-150A	0-150mm/0-6"	±0.03mm	0.01mm/0.0005"

SCRIBING CALIPER



7203-300A

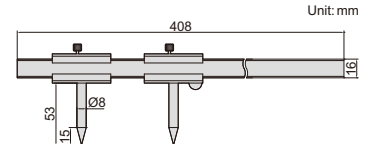

- Made of stainless steel
- Satin chrome plated reading surface
- Hardened scribe tips

Code	Range	Accuracy	Graduation
7203-300A	51-300mm	±0.1mm	0.1mm

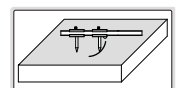

HEIGHT SCRIBER

- Grooved bottom for cylinder
- Two pins to be set against the edge of surface plate

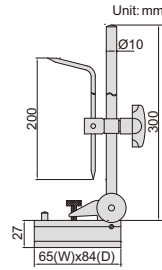

6990-300A

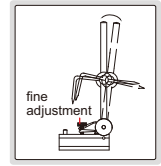
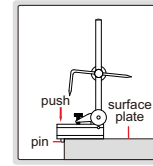

Code

6990-300A

SCRIBERS



- 7230 and 7231 are nickel plated, 7232 is zinc-plated

Code	Tip
7230	hardened tips
7231	hardened tip
7232	carbide tip

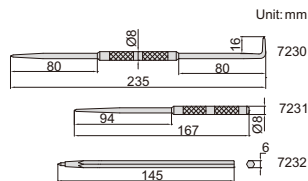

PRECISION SCREWDRIVER SET CODE ISGF-0901



ISGF-0901

packaging



- Includes:
4 pcs "-": 1.4mm, 2.0mm, 2.4mm, 3.0mm
2 pcs "+": 0#, 1#
- Rotating cap
- Material: CRV, hardness: HRC52~56

2-PIECE MEASURING TOOL SET

- Includes:
1) Digital caliper, range 0-150mm/0-6", resolution 0.01mm/0.0005" without thumb roller (code 1108-150W)
- 2) Digital outside micrometer, range 0-25mm/0-1", resolution 0.001mm/0.00005" (code 3109-25A)



5022-W

Code

5022-W

2-PIECE MEASURING TOOL SET

- Includes:
1) Dial test indicator, range 0.8mm, graduation 0.01mm (code 2380-08)
- 2) Magnetic stand



5023

Code

5023

2-PIECE MEASURING TOOL SET

- Includes:
1) Dial indicator, range 10mm, graduation 0.01mm (code 2308-10A)
- 2) Magnetic stand (code 6201-60)



5024

Code

5024

4-PIECE MEASURING TOOL SETS

- Includes:
1) Vernier caliper, range 0-150mm/0-6" graduation 0.05mm/1/128" (code 1205-150S) for 5041, graduation 0.02mm/0.001" (code 1205-1502S) for 5041-2
- 2) Outside micrometer, range 0-25mm, graduation 0.01mm (code 3202-25A)
- 3) 90° beveled edge square, 100x70mm, grade 0 (code 4790-1000)
- 4) Steel rule, 150mm/6" (code 7110-150)



5041

Code

5041

Remark

vernier caliper, graduation 0.05mm/1/128" (code 1205-150S)

5041-2 vernier caliper, graduation 0.02mm/0.001" (code 1205-1502S)

4-PIECE MEASURING TOOL SET



5042-W

Code

5042-W

- Includes:
1) Digital caliper, range 0-150mm/0-6", resolution 0.01mm/0.0005" without thumb roller (code 1108-150W)
- 2) Outside micrometer, range 0-25mm, graduation 0.01mm, (code 3202-25A)
- 3) 90° beveled edge square, 100x70mm, grade 0 (code 4790-1000)
- 4) Steel rule, 150mm/6" (code 7110-150)

6-PIECE MEASURING TOOL SETS

Includes:

- 1) Vernier caliper, range 0-150mm/0-6" graduation 0.05mm/1/128" (code **1205-150S**) for **5063**, graduation 0.02mm/0.001" (code **1205-1502S**) for **5063-2**
- 2) Outside micrometer, range 0-25mm graduation 0.01mm (code **3202-25A**)
- 3) 90° beveled edge square, 100x70mm grade 00 (code **4790-0100**)
- 4) Straight edge, 100mm (code **4700-100**)
- 5) Spring divider, 150mm (code **7260-150**)
- 6) Steel rule, 200mm/8" (code **7110-200**)



5063

Code	Remark
5063	vernier caliper, graduation 0.05mm/1/128" (code 1205-150S)
5063-2	vernier caliper, graduation 0.02mm/0.001" (code 1205-1502S)

5-PIECE MEASURING TOOL SET

Includes:

- 1) Digital caliper, range 0-150mm/0-6", resolution 0.01mm/0.0005" without thumb roller (code **1108-150W**)
- 2) Digital outside micrometer, range 0-25mm/0-1", resolution 0.001mm/0.00005" (code **3109-25A**)
- 3) Digital indicator, range 12.7mm/0.5", resolution 0.01mm/0.0005" (code **2112-10**)
- 4) Magnetic stand (code **6201-60**)
- 5) Micrometer stand (code **6300**)



5052-W

Code
5052-W

9-PIECE MEASURING TOOL SET

Includes:

- 1) Digital caliper, range 0-150mm/0-6", resolution 0.01mm/0.0005" without thumb roller (code **1108-150W**)
- 2) Outside micrometer, range 0-25mm, graduation 0.01mm (code **3202-25A**)
- 3) Protractor, range 0-180°, graduation 1° (code **4799-180**)
- 4) Pitch gauge, range 0.25-7mm, 24pcs, metric 60° thread (code **4820-124**)
- 5) Radius gauge, range 1-7mm (code **4801-17**)
- 6) Feeler gauge, range 0.05-1.00mm, 20 pcs (code **4602-20**)
- 7) 90° beveled edge square, 100x70mm, grade 0 (code **4790-1000**)
- 8) Scriber (code **7230**)
- 9) Steel rule, 150mm/6" (code **7110-150**)



5091-W

Code
5091-W

13-PIECE MEASURING TOOL SETS

Includes:

- 1) Digital caliper, range 0-150mm/0-6", resolution 0.01mm/0.0005"
- 2) Outside micrometer, range 0-25mm, graduation 0.01mm (code **3202-25A**)
- 3) Dial indicator, range 10mm, graduation 0.01mm (code **2308-10A**)
- 4) Magnetic stand (code **6201-60**)
- 5) Protractor, range 0-180°, graduation 1° (code **4799-180**)
- 6) Pitch gauge, range 0.25-7mm, 24 pcs, metric 60° thread (code **4820-124**)
- 7) Radius gauge, range 1-7mm (code **4801-17**)
- 8) Feeler gauge, range 0.05-1.00mm, 20pcs (code **4602-20**)
- 9) 90° beveled edge square, 100x70mm, grade 0 (code **4790-1000**)
- 10) Scriber (code **7230**)
- 11) Steel rule, 150mm/6" (code **7110-150**)
- 12) Depth base attachment (code **6140**)
- 13) Zero setting bar for depth base attachment



5013-W

Code	Remark
5013-W	digital caliper, without thumb roller code 1108-150W
5013	digital caliper, with thumb roller code 1108-150

GRANITE SURFACE PLATES

- Made of Indian granite, high hardness, free from deterioration or dimensional change over time, minimal changes in dimension due to temperature changes
- Meet DIN876, grade 00 is for inspection room or lab, grade 0 is for workshop
- Optional accessory: stand for granite surface plate (code **6902**), jack for granite surface plate (code **6903**)



6900-132

CUSTOM-MADE
SUPPLY SPECIAL SIZES ACCORDING
TO CUSTOMER'S REQUEST



Grade 00

Code	Size (LxWxH)	Flatness	Weight (Kg)	Max. load (Kg)
6900-132 *	300x200x60mm	2.7µm	11	30
6900-142 *	400x250x60mm	2.9µm	18	50
6900-144 *	400x400x60mm	3.1µm	29	60
6900-153 *	500x315x70mm	3.2µm	33	60
6900-164 *	630x400x80mm	3.5µm	60	65
6900-166 *	630x630x100mm	3.8µm	119	75
6900-185 *	800x500x100mm	3.9µm	120	100
6900-1106 *	1000x630x140mm	4.4µm	265	200
6900-1107 *	1000x750x150mm	4.5µm	337	300
6900-1101 *	1000x1000x150mm	4.8µm	450	400
6900-1128 *	1200x800x160mm	4.9µm	461	500
6900-1161 *	1600x1000x180mm	5.8µm	864	600

Grade 0

Code	Size (LxWxH)	Flatness	Weight (Kg)	Max. load (Kg)
6900-032 *	300x200x60mm	5.4µm	11	60
6900-042 *	400x250x60mm	5.9µm	18	100
6900-044 *	400x400x60mm	6.3µm	29	120
6900-053 *	500x315x70mm	6.4µm	33	120
6900-064 *	630x400x80mm	7.0µm	60	130
6900-066 *	630x630x100mm	7.6µm	119	150
6900-085 *	800x500x100mm	7.8µm	120	200
6900-0106 *	1000x630x140mm	8.7µm	265	400
6900-0107 *	1000x750x150mm	9.0µm	337	600
6900-0101 *	1000x1000x150mm	9.7µm	450	800
6900-0128 *	1200x800x160mm	9.8µm	461	1000
6900-0161 *	1600x1000x180mm	11.5µm	864	1200

*Supplied with manufacturer inspection certificate

STANDS FOR GRANITE SURFACE PLATES

- For medium size granite surface plates
- 5 jacks are included
- Adjusting range of jacks: 25mm
- One foot on the bottom is adjustable

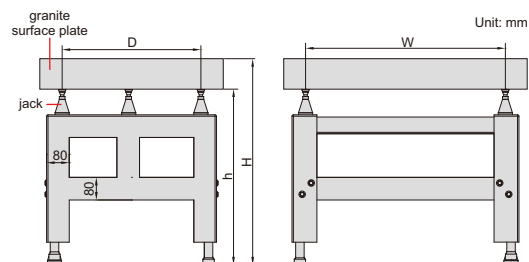

6902-64A

Low stands

Code	For granite surface plate	W	D	H (with granite surface plate)	h (without granite surface plate)
6902-64A	630x400x80mm (code 6900-064 and 6900-164)	352	224	775-800	695-720
6902-66A	630x630x100mm (code 6900-066 and 6900-166)	352	352	775-800	675-700
6902-85A	800x500x100mm (code 6900-085 and 6900-185)	448	280	775-800	675-700
6902-106A	1000x630x140mm (code 6900-0106 and 6900-1106)	560	352	755-780	615-640
6902-107A	1000x750x150mm (code 6900-0107 and 6900-1107)	560	420	755-780	605-630
6902-101A	1000x1000x150mm (code 6900-0101 and 6900-1101)	560	560	755-780	605-630
6902-128A	1200x800x160mm (code 6900-0128 and 6900-1128)	672	448	755-780	595-620
6902-161A	1600x1000x180mm (code 6900-0161 and 6900-1161)	896	560	755-780	575-600

High stands

Code	For granite surface plate	W	D	H (with granite surface plate)	h (without granite surface plate)
6902-64H	630x400x80mm (code 6900-064 and 6900-164)	352	224	1000-1025	920-945
6902-66H	630x630x100mm (code 6900-066 and 6900-166)	352	352	1000-1025	900-925
6902-85H	800x500x100mm (code 6900-085 and 6900-185)	448	280	1000-1025	900-925
6902-106H	1000x630x140mm (code 6900-0106 and 6900-1106)	560	352	1000-1025	860-885
6902-107H	1000x750x150mm (code 6900-0107 and 6900-1107)	560	420	1000-1025	850-875
6902-101H	1000x1000x150mm (code 6900-0101 and 6900-1101)	560	560	1000-1025	850-875
6902-128H	1200x800x160mm (code 6900-0128 and 6900-1128)	672	448	1000-1025	840-865
6902-161H	1600x1000x180mm (code 6900-0161 and 6900-1161)	896	560	1000-1025	820-845

V-BLOCK SETS



6896-11

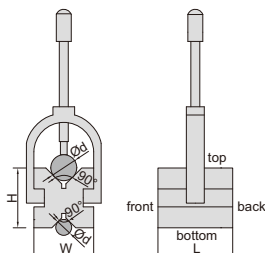

- Hold cylindrical workpieces for inspection and machining
- Two V-blocks per set
- Made of alloy steel
- Hardened to HRC60±2
- V groove on the top for large shafts
- V groove on the bottom for small shafts (except 6896-10)

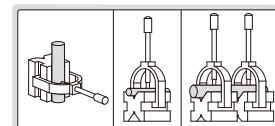

Code	Size (LxWxH)	Range of shafts (Ød)	Parallelism of both V grooves to top and bottom sides	Squareness of both V grooves to front and back sides	Height difference of a matched pair
6896-10	25x20x20mm	3-20mm	3µm	3µm	3µm
6896-11	50x40x40mm	5-30mm	5µm	5µm	5µm
6896-12	80x63x63mm	7-63mm	5µm	5µm	5µm
6896-13	100x80x80mm	7-80mm	5µm	5µm	5µm
6896-14	70x140x140mm	9-140mm	5µm	5µm	5µm

V-BLOCK SETS

- For positioning cylindrical workpieces
- Two V-blocks per set
- Each V-block has four 90° V-grooves
- Cast iron, hardness HB170-240



6805-2

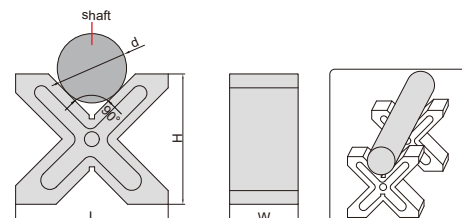

Code	Size (LxHxW)	Range of shafts (Ød)	Parallelism of four V grooves to all sides	Height difference of a matched pair
6805-1	150x130x75mm	8-120mm	15µm	20µm
6805-2	200x170x90mm	12-180mm	15µm	20µm

V-BLOCK SETS



6887-3

- Two V-blocks per set
- Made of hardened tool steel

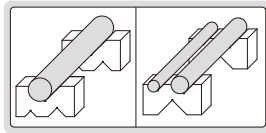
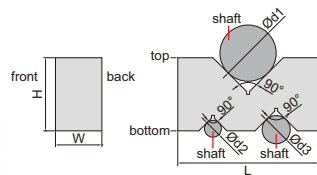

Code	Size (LxWxH)	Range of shafts (Ød1)	Range of shafts (Ød2)	Range of shafts (Ød3)
6887-1	50x19x24mm	3-32mm	3-16mm	3-22mm
6887-2	75x24x35mm	3-50mm	3-20mm	3-32mm
6887-3	100x33x52mm	3-68mm	3-26mm	3-40mm
6887-4	125x44x69mm	3-87mm	3-34mm	3-50mm

Code	Parallelism of three V grooves to top and bottom sides	Height difference of a matched pair
6887-1	5µm	5µm
6887-2	5µm	5µm
6887-3	5µm	5µm
6887-4	5µm	5µm

ROLLER BEARING V-BLOCK SETS



6888-1

- Runout accuracy: 5µm
- Parallelism of bearings to bottom: 12µm
- Two V-blocks per set
- Workpieces don't get damaged due to bearings
- Suitable for heavy workpieces

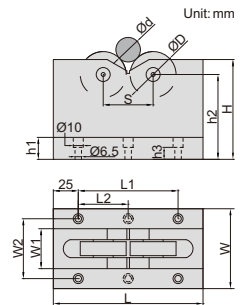

Code	W1	W2	h1	h2	h3	L1	L2	S
6888-1	22	44	20	85	12	100	-	60
6888-2	40	60	22	85	12	100	-	50
6888-3	60	80	30	124	20	180	90	120

Code	Size (LxWxH)	Code of bearings	Diameter of bearings (ØD)	Range of shafts (Ød)	Load capacity
6888-1	150x60x100mm	16004 ZZ	42mm	25-70mm	500kg
6888-2	150x80x100mm	6303 ZZ	47mm	5-55mm	1000kg
6888-3	230x100x150mm	6306 ZZ	72mm	70-200mm	1000kg

GRANITE V-BLOCK SET



6897-1

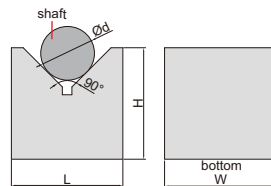

- Two V-blocks per set

Code	Size (LxWxH)	Range of shafts (Ød)	Parallelism of V groove to bottom	Height difference of a matchet pair
6897-1	70x50x70mm	6-75mm	4µm	5µm

MAGNETIC V-BLOCKS (PROFESSIONAL TYPE)

HARDENED SURFACES

HIGH PRECISION

STRONG MAGNETIC FORCE



6889-11

6889-1

- Hardened, high accuracy, strong magnetic force, for grinding, light milling, drilling and inspection of round and square workpieces
- All working surfaces are hardened to HRC60±2
- Magnetic force on top, bottom and two V grooves
- V groove on the top for large shafts
- V groove on the bottom for small shafts
- Suitable for cast iron surface plates and granite surface plates

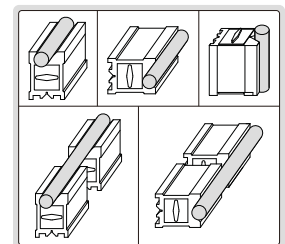

Individual

Code	Size (LxWxH)	Range of shafts (Ød)	Magnetic force	Parallelism of V grooves to top, bottom, left, right sides	Squareness of V grooves to back side
6889-11	75x56x75mm	5-40mm	85kgf	5µm	5µm
6889-22	100x70x95mm	5-65mm	150kgf	5µm	5µm
6889-33	150x75x100mm	5-70mm	190kgf	6µm	6µm
6889-55	160x125x130mm	5-140mm	220kgf	12µm	12µm
6889-44	200x125x150mm	10-140mm	400kgf	12µm	12µm

Matched pair

Code	Size (LxWxH)	Range of shafts (Ød)	Magnetic force	Parallelism of V grooves to top, bottom, left, right sides	Squareness of V grooves to back side	Height difference of a matched pair
6889-1	75x56x75mm	5-40mm	85kgf	5µm	5µm	5µm
6889-2	100x70x95mm	5-65mm	150kgf	5µm	5µm	5µm
6889-3	150x75x100mm	5-70mm	190kgf	6µm	6µm	6µm
6889-5	160x125x130mm	5-140mm	220kgf	12µm	12µm	12µm
6889-4	200x125x150mm	10-140mm	400kgf	12µm	12µm	12µm

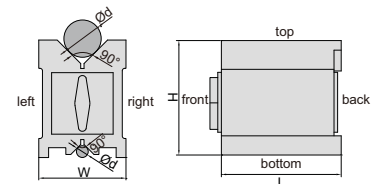

MAGNETIC V-BLOCK (ECONOMIC TYPE)

ATTENTION: NOT SUITABLE FOR STEEL OR IRON SURFACES, OTHERWISE THE MAGNETIC FORCE WILL BE REDUCED

- Parallelism of V groove to top, bottom, left and right sides: 10µm
- Hold cylindrical workpieces for inspection and machining
- Supplied in single piece
- Not hardened
- Not suitable for steel or iron surface, otherwise the magnetic force will be reduced



6890-702

ATTENTION: NOT HARDENED

Code	Size (LxWxH)	Range of shafts (Ød)	Magnetic force	Squareness of V groove to back side
6890-702	70x60x73mm	6-44mm	56kgf	10µm

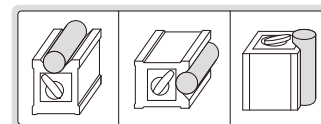
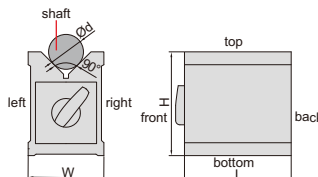

MAGNETIC V-BLOCKS (ECONOMIC TYPE)

ATTENTION: NOT SUITABLE FOR STEEL OR IRON SURFACES, OTHERWISE THE MAGNETIC FORCE WILL BE REDUCED

- Hold cylindrical workpieces for inspection and machining
- Not hardened
- V groove on the top for large shafts
- V groove on the bottom for small shafts
- Not suitable for steel or iron surface, otherwise the magnetic force will be reduced



6801-1202

ATTENTION: NOT HARDENED

Code	Size (LxWxH)	Range of shafts (Ød)	Magnetic force	Parallelism of V grooves to top, bottom, left, right side	Squareness of V grooves to back side
6801-1201	80x70x95mm	6-67mm	64kgf	10µm	10µm
6801-1202	100x70x95mm	6-67mm	80kgf	10µm	10µm
6801-1203	120x70x95mm	6-67mm	96kgf	10µm	10µm

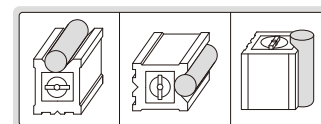
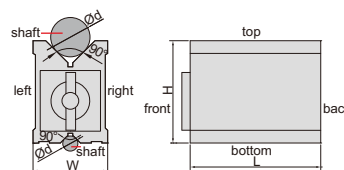

PARALLEL SET

- Pairs of matched blocks for positioning and set-up
- Screws and wrench are included
- Hardness HRC 55-62

screws and wrench are included



6531-25

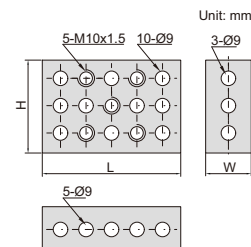

Code	Size (LxHxW)	Size accuracy	Squareness	Parallelism	Height difference of a matched pair
6531-25	75x50x25mm	10µm	7µm/25mm	10µm	10µm

PARALLEL SETS

- Parallelism between top and bottom: 5µm
- Height difference of a matched pair: 5µm
- Hardened to HRC55-60
- Made of alloy tool steel

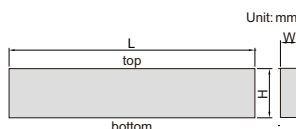

6533-144

Code	Parallels per set	Length (L)	Thickness (W)	Height (H)
6533-6	6 pairs	200mm	9.5mm	35, 40, 45, 50, 55, 58mm
6533-8	8 pairs	160mm	8mm	12, 17, 22, 25, 28, 32, 36, 38mm
6533-81	8 pairs	200mm	8mm	17, 22, 26, 28, 32, 36, 38, 42mm
6533-9	9 pairs	160mm	4mm	10, 14, 18, 22, 26, 30, 34, 38, 42mm
6533-10	10 pairs	150mm	3mm	13, 16, 19, 22, 25, 28, 31, 35, 38, 41mm
6533-144	14 pairs	150mm	10mm	14, 16, 18, 20, 22, 24, 26, 28, 30, 32, 35, 40, 45, 50mm

PARALLEL SETS

- Parallelism between top and bottom: 5µm
- Height difference of a matched pair: 5µm
- Made of alloy tool steel
- Hardened to HRC55-60

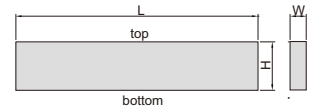

6511-20

Code	Parallels per set	Length (L)	Height (H)×Thickness (W)
6511-20	20 pairs	100mm	5×2*, 10×2, 15×2, 20×2, 6×3*, 11×3, 16×3, 21×3, 7×4*, 12×4, 17×4, 22×4, 8×5*, 13×5, 18×5, 23×5, 9×6*, 14×6, 19×6, 24×6mm
6511-24	24 pairs	125mm	11×8, 16×8, 21×8, 26×8, 31×8, 36×8, 13×10, 18×10, 23×10, 28×10, 33×10, 38×10, 15×12, 20×12, 25×12, 30×12, 35×12, 40×12, 17×14, 22×14, 27×14, 32×14, 37×14, 42×14mm
6511-241	24 pairs	150mm	11×8, 16×8, 21×8, 26×8, 31×8, 36×8, 13×10, 18×10, 23×10, 28×10, 33×10, 38×10, 15×12, 20×12, 25×12, 30×12, 35×12, 40×12, 17×14, 22×14, 27×14, 32×14, 37×14, 42×14mm

*Parallelism between top and bottom and height difference of a matched pair of 5×2mm, 6×3mm, 7×4mm, 8×5mm and 9×6mm in 6511-20 is 7µm

PARALLEL SET

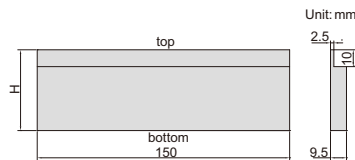
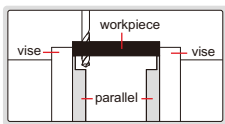

6534-6

- Height difference of a matched pair: 5µm
- Hardened to HRC55-60
- Made of alloy tool steel

Code	Parallels per set	Parallelism between top and bottom	Height (H)
6534-6	6 pairs	5µm	25, 30, 35, 40, 45, 48mm

GRANITE PARALLEL SET

- Made of granite, hard and no rusty, no dimensional change over time or temperature change
- Two parallels per set

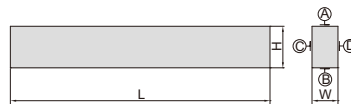
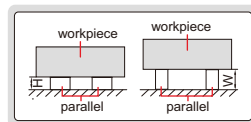

4143-250

Code	Size (LxWxH)	Parallelism between A and B	Parallelism between C and D	Height difference of a matched pair
4143-250	250x25x40mm	3µm	3µm	3µm

ANGLE PLATE SETS

- Accuracy: ±20 seconds
- For angle set-up in tooling, production and inspection
- Hardness HRC52

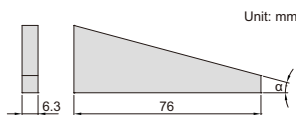

4006-12

Code	Angle plates included	Angle α
4006-10	10 pcs	1°, 2°, 3°, 4°, 5°, 10°, 15°, 20°, 25°, 30°
4006-12	12 pcs	1/4°, 1/2°, 1°, 2°, 3°, 4°, 5°, 10°, 15°, 20°, 25°, 30°

PRECISION VISES

- Parallelism: 3µm/100mm
- Squareness: 5µm/100mm
- Made of alloy steel
- Hardness HRC56-58

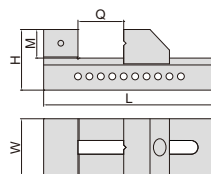

6526-80

Code	Jaw opening (Q)	Jaw width (W)	Overall length (L)	(mm)	
				H	M
6526-80	0-80mm	50mm	150mm	53	25
6526-100	0-100mm	73mm	190mm	70	35

X-AXIS STAGE

- Cross roller guides, achieve high precision and smooth movement
- Stages made of aluminum alloy



6582-602

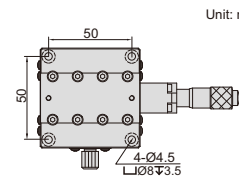
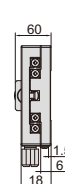
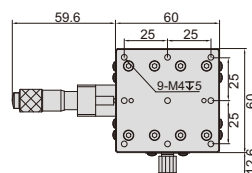

Unit: mm

SPECIFICATION (micrometer in the middle)

Code	X-axis displacement	Parallelism of top to bottom surface	Micrometer graduation	Micrometer accuracy	Maximum load	Micrometer location	Stage size	Weight
6582-602	±6.5mm	0.03mm	0.01mm	0.01mm	49N (5kgf)	middle	60x60mm	0.24kg

XY-AXIS STAGE

- Cross roller guides, achieve high precision and smooth movement
- Stages made of aluminum alloy



6584-602

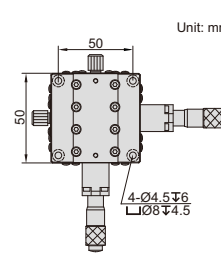
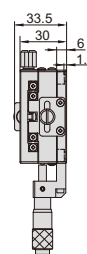
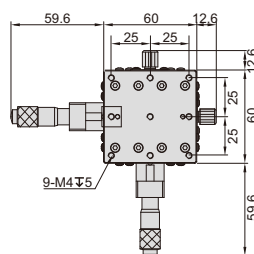

Unit: mm

SPECIFICATION (micrometer in the middle)

Code	XY-axis displacement	Parallelism of top to bottom surface	Micrometer graduation	Micrometer accuracy	Maximum load	Micrometer location	Stage size	Weight
6584-602	±6.5mm	0.06mm	0.01mm	0.01mm	49N (5kgf)	middle	60x60mm	0.48kg

CENTERING INDICATOR



2385-3

- Provides quick and accurate centering in boring and milling set-up
- Maximum speed is recommended not to exceed 800RPM

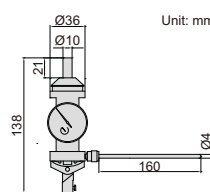
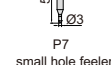
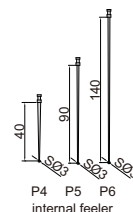
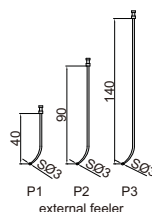
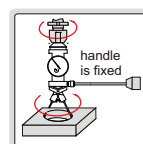
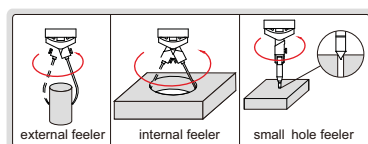

Unit: mm



Feeler	Measuring diameter	Accuracy
P1	Ø0-60mm	0.015mm
P2	Ø0-160mm	0.02mm
P3	Ø0-250mm	0.03mm
P4	Ø3.2-80mm	0.015mm
P5	Ø3.2-180mm	0.02mm
P6	Ø3.2-280mm	0.03mm
P7	Ø0-2.8mm	0.015mm

Code
2385-3

LARGE SHANK ELECTRONIC EDGE FINDERS

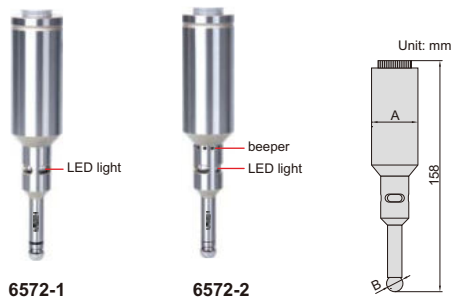

- The shank is electrically conducted to the metal workpiece through the chuck and table. The LED lights up and the beeper sounds (only for 6572-2), when the ball touches the workpiece
- Not suitable for rotary use
- Hardened shank and contact ball

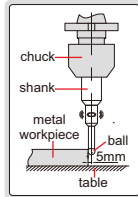

Code	Shank (A)	Contact ball (B)	Accuracy	Beeper	Battery
6572-1	Ø32mm	SØ10mm	5µm	without	23A, 12V×1 pc
6572-2	Ø32mm	SØ10mm	5µm	with	23A, 12V×1 pc

ELECTRONIC EDGE FINDERS

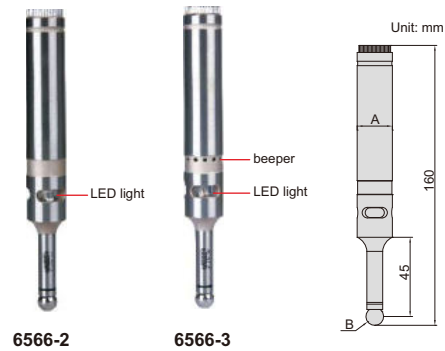

- The shank is electrically conducted to the metal workpiece through the chuck and table. The LED lights up and the beeper sounds (only for 6566-3), when the ball touches the workpiece
- Not suitable for rotary use
- Hardened shank and contact ball

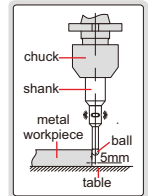

Code	Shank (A)	Contact ball (B)	Accuracy	Beeper	Battery
6566-2	Ø20mm	SØ10mm	5µm	without	23A, 12V×1 pc
6566-3	Ø20mm	SØ10mm	5µm	with	23A, 12V×1 pc

NON-MAGNETIC EDGE FINDERS

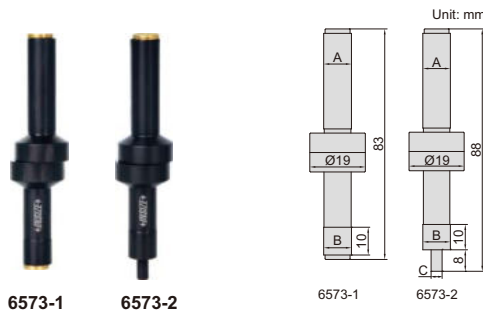

- TiAIN coating, non-magnetic, hardness HV2500, extremely wear resistance
- Suitable for machine speed 400~600rpm

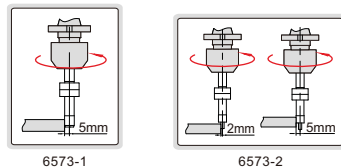

Code	Shank (A)	Contact point (B)	Contact point (C)	Accuracy
6573-1	Ø10mm	Ø10mm	—	5µm
6573-2	Ø10mm	Ø10mm	Ø4mm	5µm

EDGE FINDERS

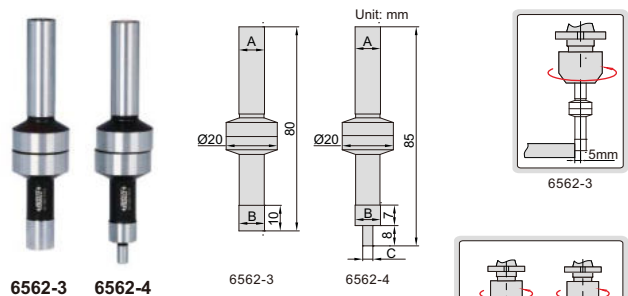

- Hardened shank and contact point
- Suitable for machine speed 400-600rpm

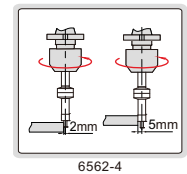

Code	Shank(A)	Contact point (B)	Contact point (C)	Accuracy
6562-3	Ø10mm	Ø10mm	—	5µm
6562-4	Ø10mm	Ø10mm	Ø4mm	5µm

EDGE FINDER

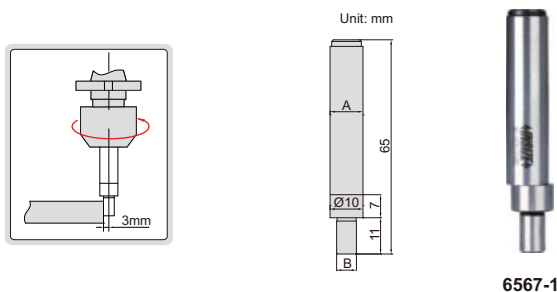

- Hardened shank and contact point
- Suitable for machine speed 400-600rpm

Code	Shank (A)	Contact point (B)	Accuracy
6567-1	Ø10mm	Ø6mm	8µm

CERAMIC EDGE FINDER



- Ceramic contact point, non magnetic
- Suitable for machine speed 400-600rpm

Code	Shank (A)	Contact point (B)	Accuracy
6568-1	Ø10mm	Ø10mm	8µm

ELECTRONIC ZERO SETTER

INSIZE PLUS
MADE IN EUROPE

- The base is electrically conducted to the cutting tools through the table and chuck, the LED lights up when the cutting tool touches the anvil
- Magnetic base
- Two batteries LR44

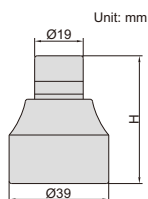

6553-50

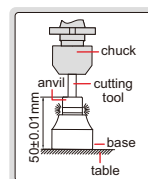
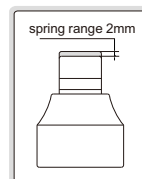

LOW TEST FORCE

Code	Height (H)	Accuracy	Test force
6553-50	50mm	±10µm	7N (at 49mm)

DIGITAL ZERO SETTER

- Resolution: 0.001mm/0.00005"
- IP65 dust/waterproof
- Buttons: on/off, mm/inch, zero
- CR2032 battery
- Automatic power off
- Magnetic base
- Automatic backlight at zero

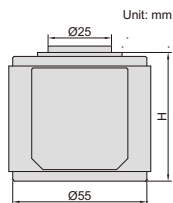

6557-50

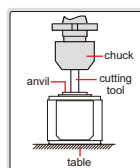

IP65
WATERPROOF

Code	Height (H)	Anvil stroke	Accuracy*	Test force	Repeatability
6557-50	50mm	2.5mm	±10µm/0.0004"	10N (at 50mm)	2µm

* The accuracy is ensured within Ø10mm of the center

ZERO SETTER

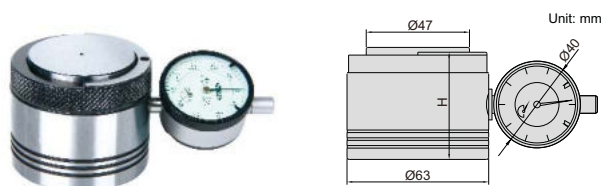

6556-50

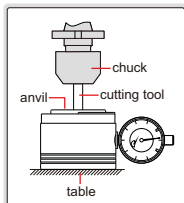
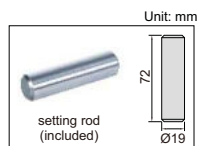

Code	Height (H)	Accuracy	Test force
6556-50	50mm	±10µm	10N (at 50mm)

ZERO SETTER



2397-502A

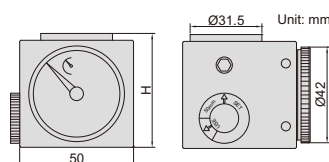

- Magnetic base

Code	Height (H)	Accuracy	Test force
2397-502A	50mm	±10µm	9N (at 50mm)

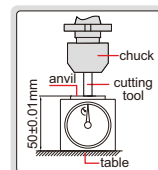

ZERO SETTER

- Magnetic base with on-off switch
- Test force: 9N (at 100mm)

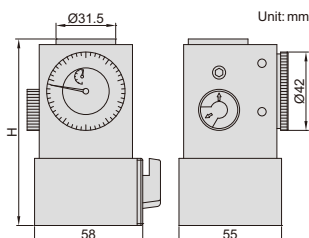

2394-100A

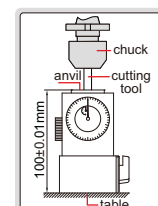

Code	Height (H)	Accuracy
2394-100A	100mm	±10µm

DIGITAL HORIZONTAL SCALES

DATA
OUTPUT

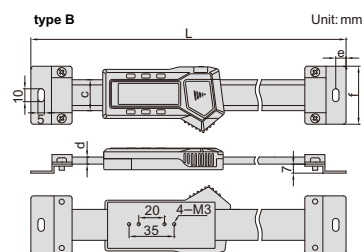
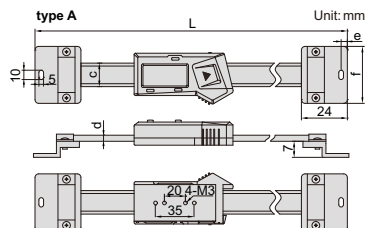

7101-300A



7101-400A

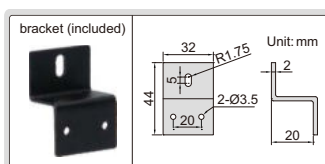

example of application

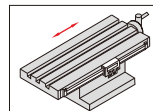

- Resolution: 0.01mm/0.0005"
- Buttons type A: on/off, zero, mm/inch, type B: on/off, zero, mm/inch, ABS, data preset
- Automatic power off, move the digital unit to turn on power
- Battery CR2032
- Data output
- Made of stainless steel
- Supplied with bracket to be mounted on the back

Code	Range	Type	Accuracy	L	c	d	e	f	Data output cable (optional)
7101-100A	100mm	A	±0.02mm	215	16	4	6	36	7315-21, 7302-21, 7305-21
7101-150A	150mm	A	±0.03mm	265	16	4	6	36	7315-21, 7302-21, 7305-21
7101-200A	200mm	A	±0.03mm	315	16	4	6	36	7315-21, 7302-21, 7305-21
7101-300A	300mm	A	±0.04mm	445	16	4	6	36	7315-21, 7302-21, 7305-21
7101-400A	400mm	B	±0.05mm	590	24	5.5	8	45	7315-22, 7302-22, 7305-22
7101-500A	500mm	B	±0.05mm	690	24	5.5	8	45	7315-22, 7302-22, 7305-22
7101-600A	600mm	B	±0.08mm	790	24	5.5	8	45	7315-22, 7302-22, 7305-22
7101-800A	800mm	B	±0.10mm	990	24	5.5	8	45	7315-22, 7302-22, 7305-22
7101-1000A	1000mm	B	±0.10mm	1240	31	10.5	10	60	7315-22, 7302-22, 7305-22

DIGITAL READOUTS



VIDEO

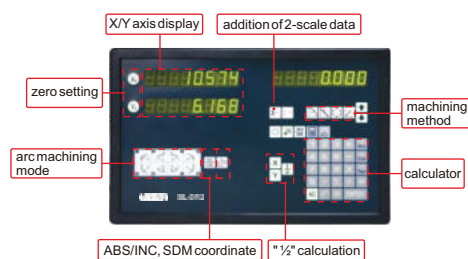

ISL-DR2

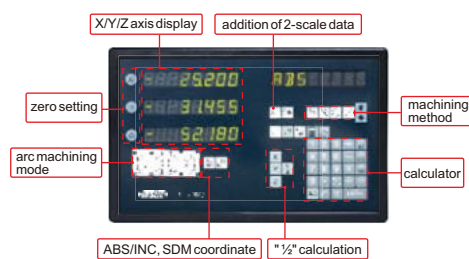

ISL-DR3

software CD (included)



mounting bracket (included)

SPECIFICATION

Code	ISL-DR2	ISL-DR3
Application	two-axis	three-axis
Scale input ports	2	3
Resolution	0.05µm, 0.1µm, 0.2µm, 0.5µm, 1µm, 2µm, 5µm, 10µm, 20µm, 50µm	
Functions	addition of 2-scale data, linearity error compensation, smoothing, RS232C interface unit, BCD code out, zero setting, preset, resolution setting, counting direction setting, inch/mm conversion, ABS/INC conversion, expansion/contraction coefficient setting, "1/2" calculation, detecting RI, bolt-hole circle machining, ramp circle machining	
Power supply	110/220V, 50/60Hz	
Dimension	295x185x45mm	
Weight	1.45kg	

STANDARD DELIVERY

Main unit	1 pc
Mounting bracket	1 pc
Ground cable	1 pc
RS232C cable	1 pc
Software CD for RS232C	1 pc

LINEAR SCALES (TTL SIGNAL)



ISL-A5-300

Series ISL-A1 and ISL-A5

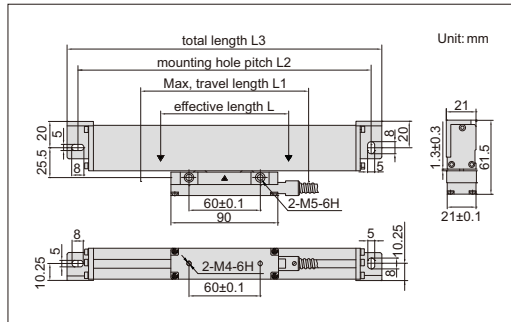

Series ISL-B5

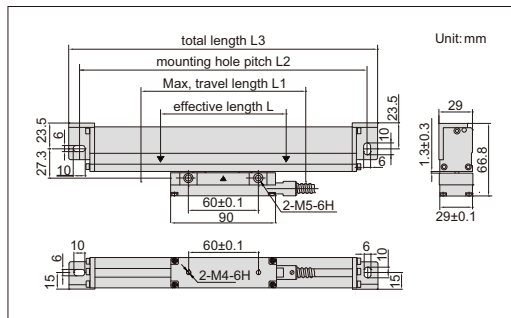

Effective length (L)	Code		
	Thin type		Thick type
	Series ISL-A1	Series ISL-A5	Series ISL-B5
50mm	ISL-A1-50	ISL-A5-50	ISL-B5-50
100mm	ISL-A1-100	ISL-A5-100	ISL-B5-100
150mm	ISL-A1-150	ISL-A5-150	ISL-B5-150
200mm	ISL-A1-200	ISL-A5-200	ISL-B5-200
250mm	ISL-A1-250	ISL-A5-250	ISL-B5-250
300mm	ISL-A1-300	ISL-A5-300	ISL-B5-300
350mm	ISL-A1-350	ISL-A5-350	ISL-B5-350
400mm	ISL-A1-400	ISL-A5-400	ISL-B5-400
450mm	ISL-A1-450	ISL-A5-450	ISL-B5-450
500mm	ISL-A1-500	ISL-A5-500	ISL-B5-500
550mm	ISL-A1-550	ISL-A5-550	ISL-B5-550
600mm	ISL-A1-600	ISL-A5-600	ISL-B5-600
650mm	ISL-A1-650	ISL-A5-650	ISL-B5-650
700mm	ISL-A1-700	ISL-A5-700	ISL-B5-700
750mm	ISL-A1-750	ISL-A5-750	ISL-B5-750
800mm	ISL-A1-800	ISL-A5-800	ISL-B5-800
850mm	ISL-A1-850	ISL-A5-850	ISL-B5-850
900mm	ISL-A1-900	ISL-A5-900	ISL-B5-900
950mm	ISL-A1-950	ISL-A5-950	ISL-B5-950
1000mm	ISL-A1-1000	ISL-A5-1000	ISL-B5-1000
1100mm		ISL-A5-1100	ISL-B5-1100
1200mm			ISL-B5-1200
1300mm			ISL-B5-1300
1400mm			ISL-B5-1400
1500mm			ISL-B5-1500
1600mm			ISL-B5-1600
1700mm			ISL-B5-1700
1800mm			ISL-B5-1800
1900mm			ISL-B5-1900
2000mm			ISL-B5-2000

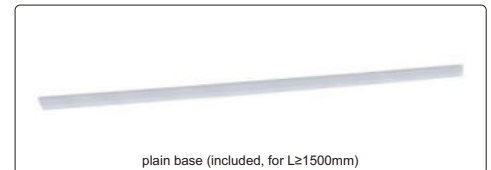
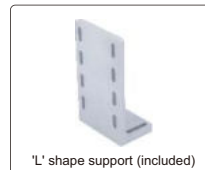

STANDARD DELIVERY

Main Unit	1 pc
'L' shape support	1 pc
Anti-dust cover	1 pc
Plain base	1 pc (for L≥1500mm)
Mounting accessories	1 package

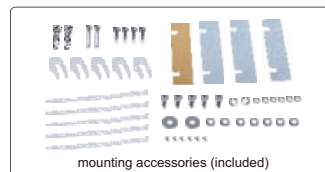

SPECIFICATION

Code	Series ISL-A1		Series ISL-A5		Series ISL-B5	
L1 (mm)	L+30(L<950)	L+50(L≥950)	L+30(L<950)	L+50(L≥950)	L+30(L<950)	L+50(L≥950)
L2 (mm)	L+132(L<950)	L+152(L≥950)	L+132(L<950)	L+152(L≥950)	L+136(L<950)	L+156(L≥950)
L3 (mm)	L+149(L<950)	L+169(L≥950)	L+149(L<950)	L+169(L≥950)	L+154(L<950)	L+174(L≥950)
Resolution	1µm		5µm		5µm	
Max. response speed	50m/min		90m/min		60m/min	
Scale grating pitch	20µm					
Scale reference point pitch	50mm					
Accuracy	±(5+5L/1000)µm L is the effective length in mm					
Cable length	3.5m (L: 50-950mm), 5m (L: 1000-1500mm), 10m (L: 1600-2000mm)					
Output signal	TTL					
Socket	9PD					
Power supply	5±0.5V					

ROUNDNESS MEASURING MACHINE CODE RCT-RA260

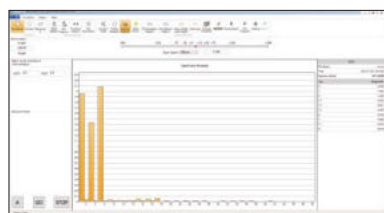

spectrum analysis

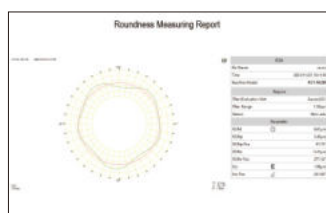

measurement

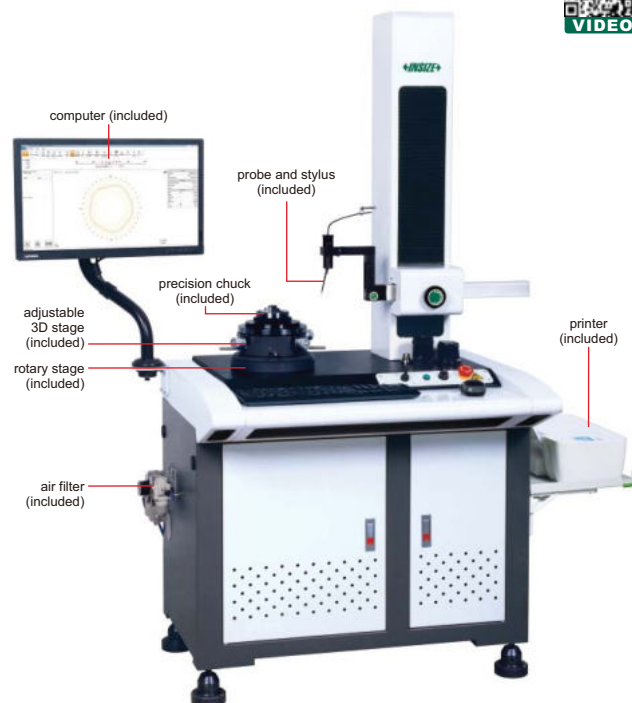

SPECIFICATION

Probe	measuring range	±300µm
	resolution	0.001µm
	linear accuracy	0.25%
Ruby stylus	size	Ø2x10mm
	direction	two directions
	adjustable angle	±45°
X axis	travel	165mm
	excess range	25mm
	drive mode	by hand
Z axis	drive mode	motor
	travel	320mm
	movement speed	0.5~10mm/s
Rotary stage	rotation accuracy	(0.025+6H/10000)µm for H≤20mm, H is the measuring height in mm
	rotation speed	6rpm
	max. measuring diameter	260mm
	max. workpiece diameter (rotation diameter)	400mm
Rotary axis	radial rotation accuracy	±0.0125µm
	axial runout accuracy	±0.05µm
Adjustable 3D stage	diameter	180mm
	adjustment range of center	±3mm
	adjustment range of level	±2°
Granite stage	weight capacity	20kg
	external grip diameter	Ø1~Ø81mm
	internal grip diameter	Ø31~Ø70mm
Precision chuck	pressure range	0~0.8MPa
	oil mist removal accuracy	0.01µm
	export oil mist concentration	0.5mg/m³
Dimension (LxWxH)		1300×795×1715mm
Power supply		220±10%V, 50Hz
Power		500W
Weight		320kg

- Air-floating spindle
- Can measure roundness, coaxiality, concentricity, flatness, radial runout, axial runout, parallelism and perpendicularity.
- Spectrum analysis, automatic gap/burr removal, waveform analysis
- 4 roundness evaluation methods: smallest area method, least square method, smallest circumscribed circle method, largest inscribed circle method
- Measuring filter: 1-15µr, 1-50µr, 1-150µr, 1-250µr, 1-500µr, 15-100µr, 15-500µr, 2-15µr
- Filter form: Gauss (ISO standard)
- Software is included, for measurement, analysis, data output, etc.

STANDARD DELIVERY

Main unit	1 pc
Probe (with ruby stylus)	1 pc each
Standard block	1 pc
Precision chuck	1 pc
Adjustable 3D stage	1 pc
Rotary stage	1 pc
Computer	1 pc
Software	1 set
Printer	1 pc
Air filter	1 set
Installation tools	1 set



standard block (included)

OPTIONAL ACCESSORY

Probes	refer to details
Precision chucks	refer to details
Dryer	ISC-DRY

SPECIFICATION OF PROBES

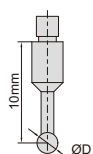

Code	Diameter (ØD)	Remark
RCT-RA260-T1	2mm	included
RCT-RA260-T2	0.5mm	optional
RCT-RA260-T3	1mm	optional
RCT-RA260-T4	4mm	optional
RCT-RA260-T5	8mm	optional

SPECIFICATION OF PRECISION CHUCKS

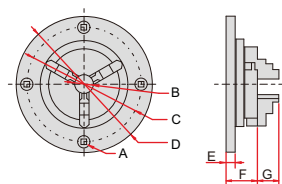

Code	A	B	C	D	E	F	G	Clamping range (mm)		Remark
								external grip dia.	internal grip dia.	
RCT-RA260-C1	M5x0.8	16	100	118	8	28	13	Ø0.8~63	Ø23~58	optional
RCT-RA260-C2	M6x1.0	20	116	143	10.5	37	15	Ø1~81	Ø31~70	included
RCT-RA260-C3	M6x1.0	26	140	168	10	39	19	Ø1~100	Ø36~90	optional

SURFACE PROFILE MEASURING MACHINE CODE SPM-1000

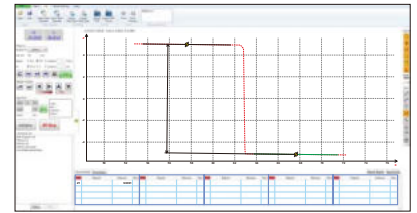
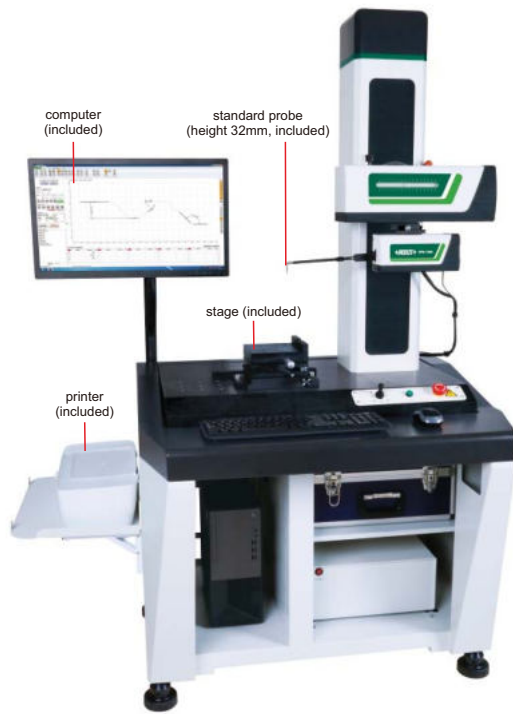

calibration

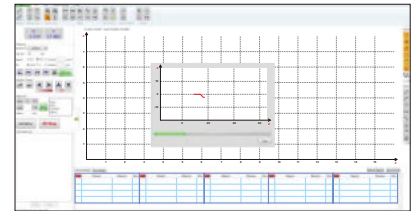

contour scanning

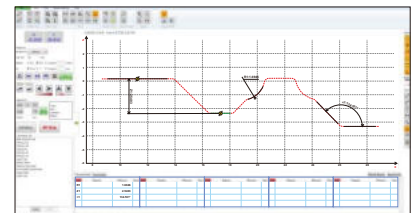

dimension measurement

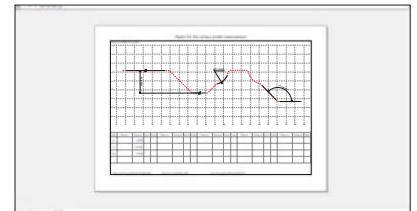

data output

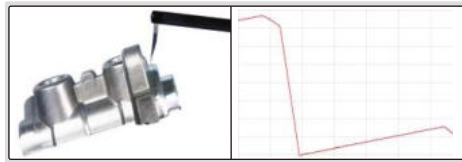

- Software is included, for surface profile measurement and data output
- Probe compensation
- Output as format txt, csv, etc.
- Large range design, the leverage ratio is 1:2.2, maintain the original accuracy of the sensor
- The overall structure of the Z-axis sensor does not have any elastic components, ensuring the measuring force is constant regardless the position of probe

SPECIFICATION

X axis measuring range	140mm
X axis resolution	0.2μm
X axis straightness	0.8μm/100mm
X axis traverse speed	0.1~10mm/s
Z axis measuring range	±20mm
Z axis resolution	0.05μm
Z axis traverse speed	0.5~10mm/s
Linear accuracy	±(1.5+ 0.2H)μm, H is measuring height in mm
Angular measuring accuracy	±2'
Arc measuring accuracy	±(2+R/8)μm, R is 2~10mm standard ball
Radius of probe tip	25μm
Traverse direction	backward
Measuring force	6.86~9.8mN
Measuring unit	mm/inch
Traceable angle	72° (upward), 87° (downward)
Drive mode	motor
Travel of Z axis	430mm
Dimension (L×W×H)	1200×700×1780mm
Power supply	220±5%V, 50Hz
Weight	320kg

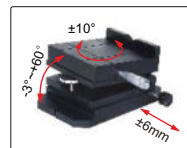

stage (included)



vise (included)



standard balls (included)

STANDARD DELIVERY

Main unit	1 pc
Standard probe and arm	1 pc of each
Standard block	2 pcs
Standard ball	2 pcs
Standard shaft	1 pc
Stage	1 pc
Vise	1 pc
Measuring arm	1 pc
Computer	1 pc
Measurement software	1 pc
Printer	1 pc
Installation tools	1 set



standard blocks (included)



standard shaft (included)

OPTIONAL ACCESSORY

Probe and arm	refer to details
---------------	------------------

ROUGHNESS TESTER CODE ISR-C002

CAN BE OPERATED BY
MOBILE PHONES OR COMPUTERS

BLUETOOTH

DATA
OUTPUT

- Roughness tester can be operated by mobile phones (only Android system) or computers
- Data can be sent to Excel by connecting to computers via bluetooth or SPC cable
- Support bluetooth printer
- 21 roughness parameters
- Display roughness value, profile and curve
- Memory of maximum 100 results
- Automatic power off



software CD (included)

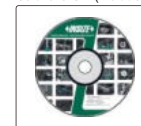

probe cover (included)

put the small workpieces directly under the probe for measurement

adjustable stand (included)

bluetooth printer (optional)

light duty test stand (optional)

the maximum workpiece height is 220mm

heavy duty test stand (optional)

the maximum workpiece height is 310mm

operate roughness tester by computers

connect to computers via USB cable (software is included), display roughness values, profile and curve

operate roughness tester by mobile phones

connect to mobile phones via bluetooth (only Android system), display roughness values, profile and curve

extension rod (optional), code ISR-C002-ER

transverse rod (optional), code ISR-C002-TR

deep groove probe (optional), code ISR-C002-DGP

small hole probe (optional), code ISR-C002-SBP

data can be sent to Excel by connecting to computer via bluetooth or SPC cable

via bluetooth

receiver (optional)

SPC cable (optional)

via SPC cable

receiver (optional)

deep groove probe (optional), code ISR-C002-DGP1

SPECIFICATION

Parameters	Ra, Rz, Rq, Rv, Rp, RS, R3z, R3y, Rt, Rz (JIS), Rk, Rku, Rsm, Rpc, Rpk, Rvk, Rsk, Mr1, Mr2, Ry (JIS), Rmax	
Range	320μm (-160μm~160μm)	
Accuracy	±10%	
Resolution (Ra)	0.001μm	
Probe	type	inductive
	stylus radius/angle	5μm/90°
	stylus material	diamond
Measuring force	4mN	
Measuring unit	μm/μin	
Cut off	0.25/0.8/2.5mm	
Number of cut-off	1 to 5	
Moving speed	0.5mm/s, 1mm/s	
Memory	100 measurement results	
Output	bluetooth and USB	
Power	built-in rechargeable battery	
Dimension (L×W×H)	141×55×40mm	
Weight	400g	

STANDARD DELIVERY

Main unit	1 pc
Standard probe	1 pc
Calibration block and support	1 pc of each
Adjustable stand	1 pc
Probe cover	1 pc
Software and USB cable	1 pc
AC/DC adapter	1 pc

OPTIONAL ACCESSORY

Extension rod	ISR-C002-ER
Transverse rod	ISR-C002-TR
Tiny hole probe	ISR-C002-SBP
Deep groove probe	ISR-C002-DGP
Deep groove probe	ISR-C002-DGP1*
Light duty test stand	ISR-C002-STAND1
Heavy duty test stand	ISR-C002-STAND
Bluetooth printer	ISR-C002-PRINTER
Receiver	ISR-C300-RECEIVER
SPC cable	ISR-C300-SPC

*Need to be delivered with roughness tester ISR-C002

screen display

measurement result

Rmr analysis

roughness profile

ROUGHNESS TESTER (SEPARABLE TYPE) CODE ISR-C300

CAN BE OPERATED BY
COMPUTER OR MOBILE PHONE

TOUCH SCREEN

BLUETOOTH

DATA
OUTPUT

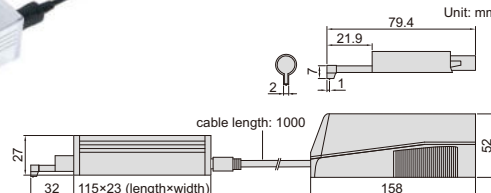

- Roughness tester can be operated by mobile phone (only android system) or computers
- Data can be sent to Excel by connecting to computers via bluetooth or SPC cable
- Support bluetooth printer
- 22 roughness parameters
- Meet ISO, DIN, ANSI, JIS standards
- Display roughness values, profile and curve
- Memory of maximum 100 data and waveform
- Built-in lithium battery, working time more than 50 hours
- Touch screen
- Automatic power off

operate roughness tester by computers

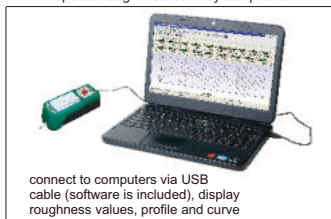

connect to computers via USB cable (software is included), display roughness values, profile and curve

operate roughness tester by mobile phones



connect to mobile phones via bluetooth (only Android system), display roughness values, profile and curve

data can be sent to Excel by connecting to computer via bluetooth or SPC cable

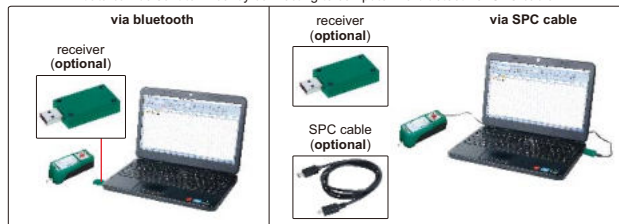

optional probes

Unit: mm

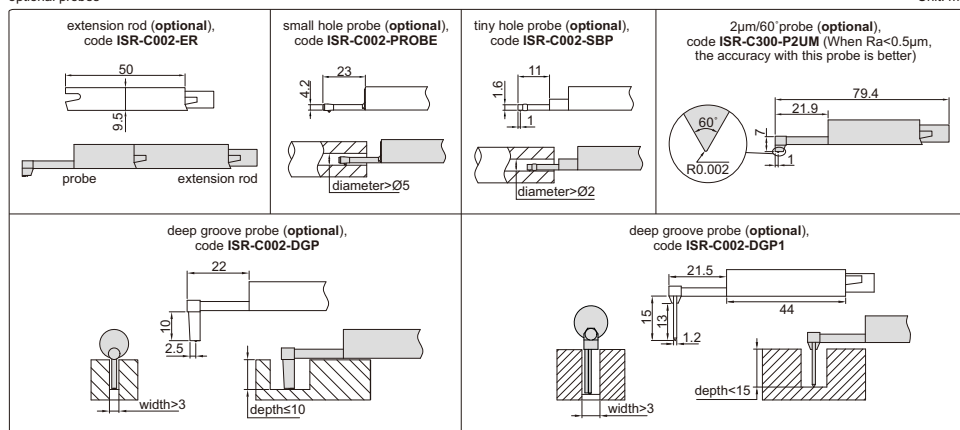

roughness tester screen display

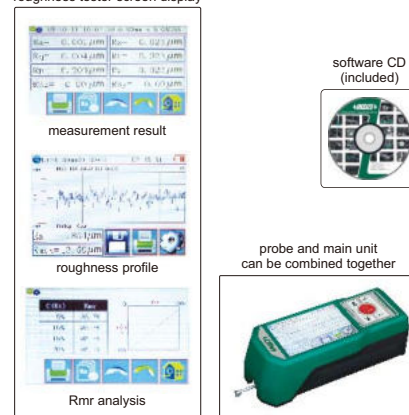

SPECIFICATION

Parameters		Ra, Rz, Rq, Rv, Rp, Rs, R3z, R3y, Rt, Rc, Rz (JIS), Rk, Rku, Rsm, Rpc, Rpk, Rvk, Rsk, Mr1, Mr2, Ry, Rmax
Range	X axis	17.5mm
	Z axis	320µm (-160µm~160µm)
Accuracy		±10%
Resolution (Ra)		0.001µm
Probe	type	inductive
	stylus radius/angle	5µm/90°
	stylus material	diamond
Measuring force		4mN
Measuring unit		µm/µin
Cut off		0.25/0.8/2.5mm
Number of cut-offs		1~5
Moving speed		0.135mm/s, 0.5mm/s, 1mm/s
Memory		100 measurement results
Output		bluetooth and USB
Power		built-in rechargeable battery
Dimension (L×W×H)		158×64×52mm
Weight		400g

magnetic stand adapter (included)



height gage adapter (optional)



NOTE: Please check whether the adapter can fit your height gages. When using INSIZE height gages, please use the dial test indicator holder of height gages

light duty test stand (optional)



heavy duty test stand (optional)



To be continued

Continued from previous page

bluetooth printer (optional)



adjustable stand (included)

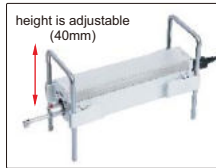

STANDARD DELIVERY

Main unit	1pc
Standard probe	1pc
Calibration block and support	1pc of each
Connecting cable (long and short)	1pc of each
Magnetic stand adapter	1pc
Adjustable stand	1pc
Touch pen	1pc
Software and USB cable	1pc
AC/DC adapter	1pc

OPTIONAL ACCESSORY

Extension rod	ISR-C002-ER
Small hole probe	ISR-C002-PROBE
Tiny hole probe	ISR-C002-SBP
Deep groove probe	ISR-C002-DGP
Deep groove probe	ISR-C002-DGP1*
2µm/60° probe	ISR-C300-P2UM
Bluetooth printer	ISR-C002-PRINTER
Height gage adapter	ISR-C300-LB1
Receiver	ISR-C300-RECEIVER
SPC cable	ISR-C300-SPC
Support for flat surface	ISR-C300-COVER1
Support for cylindrical surface	ISR-C300-COVER2
Light duty test stand	ISR-C002-STAND1
Heavy duty test stand	ISR-C002-STAND

probe support (optional)

support for cylindrical surface

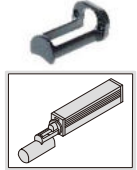

support for flat surface

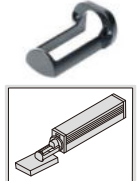

*Need to be delivered with roughness tester **ISR-C300**

**ROUGHNESS TESTER (BASIC TYPE)
CODE ISR-C003**

ATTENTION: THIS ROUGHNESS TESTER IS NOT SUITABLE FOR ROUGH TURNING, MILLING AND PLANING WORKPIECES



SPECIFICATION

Parameters	Ra, Rz, Rq, Rt	
Range	Ra, Rq: 0.05~15µm Rz, Rt: 0.1~50µm	
Accuracy	±10%	
Resolution (Ra)	0.01µm	
Probe	type	piezoelectric
	stylus radius/angle	10µm/90°
	stylus material	diamond
Measuring force	5mN	
Measuring unit	µm/µin	
Cut off	0.25/0.8/2.5mm	
Evaluation length	1.25mm for cut off 0.25mm 4mm for cut off 0.8mm 5mm for cut off 2.5mm	
Moving speed	0.75mm/s	
Power	built-in rechargeable battery	
Dimension (L×W×H)	106×70×24mm	
Weight	200g	



calibration block (included)



- Unit: µm, µin
- Automatic power off

STANDARD DELIVERY

Main unit	1 pc
Calibration block	1 pc
AC/DC adapter	1 pc

fixture for small shafts (optional)



application

OPTIONAL ACCESSORY

Fixture for small shafts	ISR-C003-FIXTURE
--------------------------	------------------

**SURFACE ROUGHNESS SPECIMEN SET
CODE ISR-CS130-W**



- For checking, identifying and specifying the roughness by symbol
- Rust-proof, made of pure Nickel

Machining method	Roughness (Ra)	Roughness (Rz)	Quantity
Flat lapping	0.05, 0.1, 0.2µm	0.55, 1, 1.6µm	3 pcs
	2, 4, 8µin		
Reaming	0.4, 0.8, 1.6µm	3, 6, 10µm	3 pcs
	16, 32, 63µin		
Plain grinding	0.05, 0.1, 0.2, 0.4, 0.8, 1.6µm	0.55, 1, 1.6, 3, 6, 10µm	6 pcs
	2, 4, 8, 16, 32, 63µin		
Horizontal milling	0.4, 0.8, 1.6, 3.2, 6.3, 12.5µm	2.5, 4, 8, 16, 32, 50µm	6 pcs
	16, 32, 63, 125, 250, 500µin		
Vertical milling	0.4, 0.8, 1.6, 3.2, 6.3, 12.5µm	2.5, 4, 8, 16, 32, 50µm	6 pcs
	16, 32, 63, 125, 250, 500µin		
Turning	0.4, 0.8, 1.6, 3.2, 6.3, 12.5µm	2.5, 4, 8, 16, 32, 50µm	6 pcs
	16, 32, 63, 125, 250, 500µin		

JIG SET FOR CMM CODE ISY-600



acrylic tray (included)

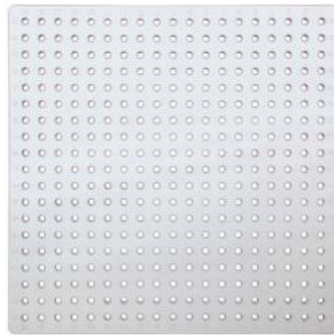

ISY-600

application example



VIDEO

Product	Code	Size (mm)	Quantity
stand	ISY-600-80001	Ø12×50	6
	ISY-600-80002	Ø12×30	6
	ISY-600-80007	Ø12×20	6
stand	ISY-600-80003	Ø16×50	6
	ISY-600-80004	Ø16×30	6
	ISY-600-80008	Ø16×20	6
stand	ISY-600-80005	Ø20×50	6
	ISY-600-80006	Ø20×30	6
	ISY-600-80009	Ø20×20	6
spring stand	ISY-600-800010	—	2
universal support with damping	ISY-600-800012	—	2
stand with fine adjustment	ISY-600-800013	Ø20×55-78	2

Product	Code	Size (mm)	Quantity
magnetic stand (magnetic top surface)	ISY-600-800014	Ø20×20	4
stand for slice parts	ISY-600-800015	Ø20×20	2
adaptor	ISY-600-800016	Ø20×15	6
clamping screw for base plate	ISY-600-800017	—	2
V shaped support	ISY-600-800018	Ø20×25	2
clamping screw	ISY-600-800019	—	6
sliding support plate	ISY-600-800020	68×20×10	6
clip	ISY-600-800021	12×70	5
chuck support	ISY-600-800022	—	2
clip stand	ISY-600-800023	Ø6×80	2
	ISY-600-800024	Ø6×40	3
aluminum support head	ISY-600-800025	—	3
nylon support head	ISY-600-800026	—	3
wrench	ISY-600-800027	Ø8×48	2
base plate	ISY-600-800028	400×400×15	1

JIG SET FOR CMM CODE ISY-100



VIDEO

application examples

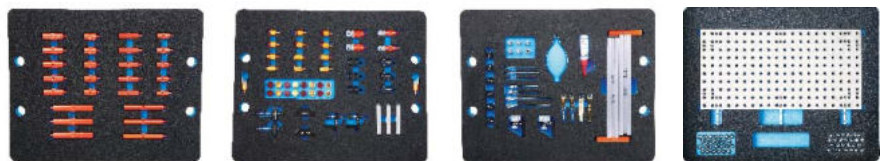
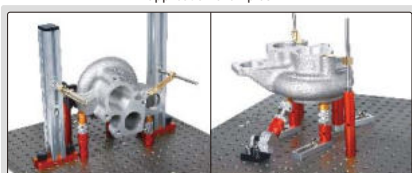

ISY-100







To be continued

Continued from previous page

Product	Code	Size (mm)	Quantity	Application
	ISY-100-1001	Ø16×30	5	
	ISY-100-1002	Ø16×50	5	
	ISY-100-1003	Ø16×100	3	
	ISY-100-1004	Ø20×30	5	
	ISY-100-1005	Ø20×50	5	
	ISY-100-1006	Ø20×100	3	
stand with fine adjustment	ISY-100-2001	Ø16×45~60	2	height adjustment: 45~60mm
stand with fine adjustment	ISY-100-2003	Ø20×45~60	2	
horizontal spring stand	ISY-100-4001	—	2	
horizontal screw stand	ISY-100-5001	—	2	
magnetic stand (magnetic top surface)	ISY-100-7001	Ø20×25	3	
stand for slice parts	ISY-100-8001	Ø20×25	2	ISY-100-8001 and ISY-100-8002 use cooperatively 
clamping stand for slice parts	ISY-100-8002		1	
clip	ISY-100-1201	—	2	
clip	ISY-100-1301	—	2	
clip stand	ISY-100-1401	Ø6×60	2	
	ISY-100-1402	Ø6×100	2	
vertical square column	ISY-100-3003	30×30×250	2	
sliding support plate	ISY-100-1801	78×20×10	3	
clamping screw	ISY-100-2301	Ø8×20	6	
screw	ISY-100-2302	Ø8×20	6	
base plate	ISY-600-400200	400×400×12 hole size: M8×1.25 hole center distance: 20	2 pieces	—

Product	Code	Size (mm)	Quantity	Application
wrench	ISY-100-3701	Ø3.8×70	1	—
wrench	ISY-100-3801	M2.5	1	—
	ISY-100-3802	M5	1	—
	ISY-100-3803	M6	1	—
45° stand	ISY-100-9001	—	2	
V shaped support	ISY-100-1901	—	2	
V shaped support	ISY-100-1902	—	2	
marker	ISY-6100-1501	—	52*	
dust cleaner	ISY-100-3501	—	1	—
lubricating oil	ISY-100-3601	—	1	—

* Letter A~Z, number 0~25

Product	Code	Quantity	Material	Application
	ISY-100-27016	2	aluminum	
	ISY-100-27018	2	nylon	
	ISY-100-27026	2	aluminum	
	ISY-100-27028	2	nylon	
	ISY-100-27036	2	aluminum	
	ISY-100-27038	2	nylon	
	ISY-100-27046	2	aluminum	
	ISY-100-27048	2	nylon	
	ISY-100-27056	2	aluminum	
	ISY-100-27058	2	nylon	
	ISY-100-27066	2	aluminum	
	ISY-100-27068	2	nylon	
	ISY-100-27076	2	aluminum	
	ISY-100-27078	2	nylon	

JIGS FOR CMM (ANVIL Ø6mm)

CAN BE CUSTOMIZED



ISY-400



ISY-400-1



ISY-400-2



ISY-400-3



ISY-400-4



ISY-400-5



ISY-400-6

Code	Product	Remark
ISY-400	jig set	including 3 pcs ISY-400-1, 9 pcs ISY-400-2, 9 pcs ISY-400-3, 1 pc ISY-400-4, 3 pcs ISY-400-5, 3 pcs ISY-400-6

Code	Product	Size	Anvil area	Anvil stroke
ISY-400-1	spring anvil	135×60×90	36×100	24

Code	Product	Size (mm)
ISY-400-2	block	120×60×20
ISY-400-3	block	120×60×30
ISY-400-4	base plate	500×500×12
ISY-400-5	connecting plate	130×120×12
ISY-400-6	clamp handle	—

JIGS FOR CMM (ANVIL Ø6mm)

CAN BE CUSTOMIZED

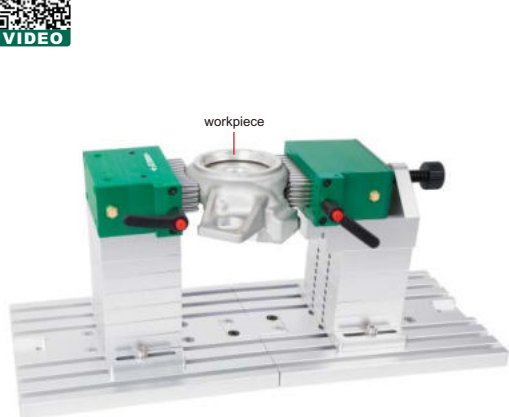

ISY-500



ISY-500-1



ISY-500-2



ISY-500-3



ISY-500-4



ISY-500-5



ISY-500-6



ISY-500-7

Code	Product	Remark
ISY-500	jig set	including 1pc ISY-500-1, 1 pc ISY-500-2, 2 pcs ISY-500-3, 10 pcs ISY-500-4, 2 pcs ISY-500-5, 1 pc ISY-500-6, 2 pcs ISY-500-7

Code	Product	Size	Anvil area	Anvil stroke
ISY-500-1	spring anvil	135×60×90	36×100	24
ISY-500-2	adjustable spring anvil (range 0-40mm)	134×120×130	36×100	24

Code	Product	Size (mm)
ISY-500-3	base plate	300×240×20
ISY-500-4	block	120×90×20
ISY-500-5	connecting plate	170×90×15
ISY-500-6	connecting block of base plate	80×50×10
ISY-500-7	clamp handle	—

LASER SCAN MICROMETERS

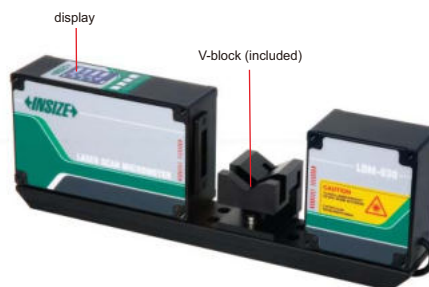
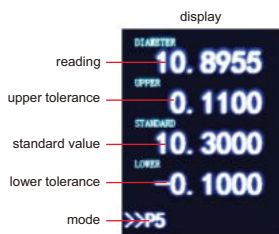

LDM-030

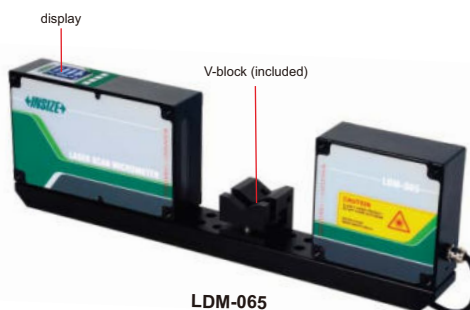

LDM-065

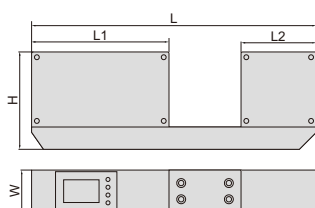

- Measure external diameter, ellipticity, run-out, maximum diameter of tools, etc.
- Can be used for transparent or non transparent workpieces
- Tolerance measurement
- Online or offline measurement
- Connected with computer and PLC



calibration gage (optional)

SPECIFICATION

Code	LDM-030	LDM-065
Measuring range	0.1~30mm	0.5~65mm
Resolution	0.01/0.1/1/10/100µm selectable	
25°C accuracy	±(0.5+10%D)µm, D is measuring diameter in mm	
Repeatability	±(0.3+5%D)µm, D is measuring diameter in mm	
Laser wave length	650nm	
Measuring speed	800~3200times/s (adjustable)	
Operation temperature	0~50°C	
Operation humidity	35~85RH without condensation	
Output	dual channel RS485	
Alarm output	24V, 1A	
Power supply	DC24V, 2A	
Dimension (L×W×H)	351×52×120mm	469×52×156mm
Weight	5kg	8kg

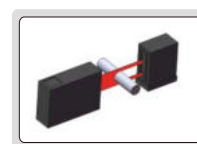

measure external diameter

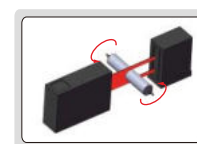

measure ellipticity and run-out

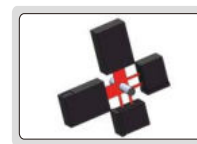

two-axis measurement

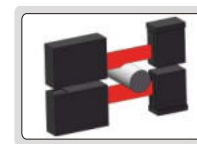

large size measurement

STANDARD DELIVERY

Main unit	1 pc
V-block	1 pc
AC/DC adapter	1 pc
RS485 cable	1 pc

OPTIONAL ACCESSORY

Calibration gage	custom made
------------------	-------------

Dimension

(mm)

Code	LDM-030	LDM-065
L	351	469
W	52	52
H	120	146
L1	170	203
L2	95	131

OPTICAL TRANSMISSION PROBES FOR CNC MACHINE TOOLS

IP68
WATERPROOF

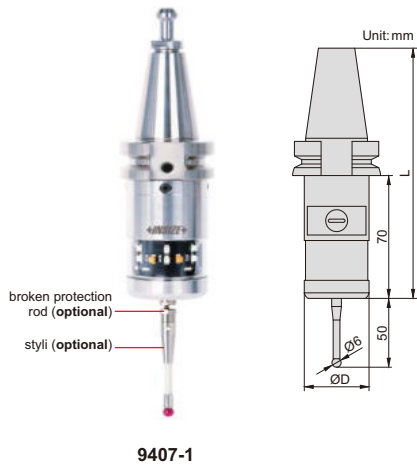

9407-1

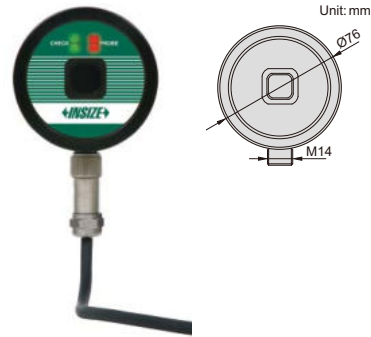

9407-1A

- On-machine measurement
- Multi-channel transmission between probes and receivers, for anti-interference
- Transmit three kinds of signals: trigger, contact and low battery voltage
- With spindle protection function
- Optical transmission range: 1m, 3m, 5m
- Automatic power off in 3 seconds, move styli to power on

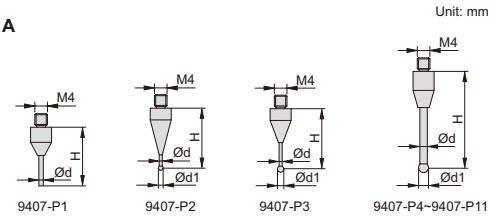

OPTICAL PROBE SPECIFICATION

Code	9407-1*	9407-2*
Probe length (L)	140mm	180mm
Probe diameter (ØD)	40mm	46.5mm
Trigger accuracy of styli in any one direction	1µm	
Protection stroke triggered by styli in all directions	X and Y axis stroke: ±12.5°, Z axis stroke: 5mm	
Trigger force of styli in all directions	X and Y axis: 0.9N, Z axis: 6N	
Applicable spindle	BT30	BT50
Dust/waterproof	IP68	
Power supply	2×LS14250 lithium battery	

*9407-1 can be customized to spindle below BT40, 9407-2 can be customized to spindle over BT50; HSK, SK and ISO series spindles also can be customized.

STYLI (OPTIONAL)

Code	H	Ød	Ød1	Material of measuring face
9407-P1	20	1	—	carbide
9407-P2	19.5	0.7	1	ruby
9407-P3	19	1.4	2	ruby
9407-P4	20	0.7	1	ruby
9407-P5	20	1.5	2	ruby
9407-P6	20	2	3	ruby
9407-P7	20	2	4	ruby
9407-P8	50	3	4	ruby
9407-P9	50	3.8	5	ruby
9407-P10	50	4.5	6	ruby
9407-P11	75	3.8	5	ruby

RECEIVER SPECIFICATION

Code	9407-1A
Protection function	low battery voltage or probe transmitting signal all the time**
Applicable probe	code 9407-1, 9407-2
Cable length	5m
Dust/waterproof	IP68

** When the battery voltage is low or the probe transmits signal all the time, the receiver will send a signal to the machine tool to stop working

BROKEN PROTECTION ROD (OPTIONAL)

Code	H
9407-R1	12mm
9407-R2	22mm

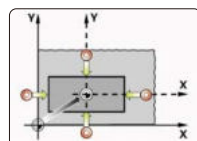
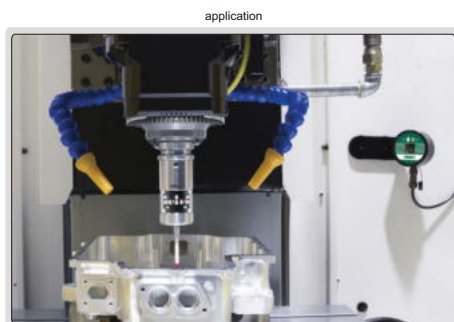
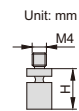

find center of rectangular boss

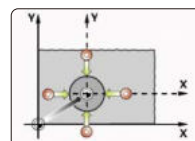

find center of the round boss

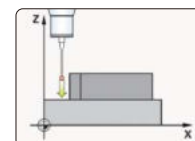

measure position of point on any axis

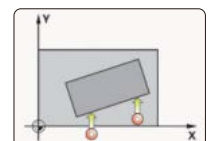

measure inclination of line

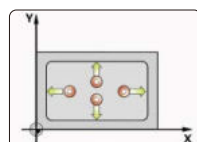

measure rectangular cavity

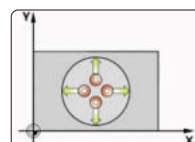

measure round cavity

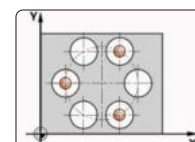

measure center of holes

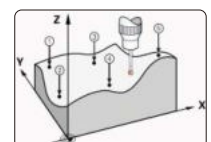

measure freeform surfaces

TOOL PRESETTER (BASIC TYPE) CODE TLP-300H



rotate tools



standard rod (included)



BT50/BT40 converter (optional)



BT50/BT30 converter (optional)

- Absolute linear scales, zero setting is not needed after power on and off

SPECIFICATION

Maximum tool diameter (X axis)	Ø300mm
Height measuring range	60~300mm
Repeatability	0.005mm
Measuring accuracy	0.02mm
Linear scale resolution	0.005mm
Dial indicator graduation	0.01mm
Spindle holder	BT50
Power supply	110/220V, 50/60HZ
Dimension (L×W×H)	600x365x690mm
Weight	68kg

STANDARD DELIVERY

Main unit	1 pc
BT50 spindle holder	1 pc
Standard rod	1 pc
Dial indicator	2 pcs
Wrench	1 set
Anti-dust cover	1 pc

OPTIONAL ACCESSORY

BT50/BT30 converter	TLP-300H-C1
BT50/BT40 converter	TLP-300H-C2

PROFILE PROJECTOR CODE ISP-Z3015



OPTIONAL ACCESSORY



lens



holder with clamp



swivel center support



V-block with clamp



blue filter



demo sample

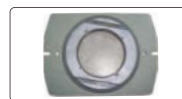

rotary table (glass plate diameter 100mm)



overlay chart (protractor with 1° graduation, radius with 1mm increment)



50mm reading scale (check magnification accuracy)



300mm calibration scale (check magnification accuracy together with 50mm reading scale or calibrate measuring accuracy)

To be continued

Continued from previous page

SPECIFICATION

Lens	magnification	10X (included)	20X (optional)	50X (optional)	100X (optional)
	view field	Ø30mm	Ø15mm	Ø6mm	Ø3mm
	working distance	77.7mm	44.3mm	38.4mm	25.3mm
Max. workpiece height		90mm	90mm	90mm	90mm
Magnification accuracy		±0.08%			
Image		erect image			
Projector screen		diameter: Ø300mm			
		rotation range: 0°~360°, resolution: 1" or 0.01°			
		reference lines: cross-hairs			
Stage	metal stage size	340×152mm			
	glass stage size	196×96mm			
	X-Y stage travel	range: 150×50mm			
		resolution: 0.5µm			
	Z (focus) travel range	accuracy: (4+L/25)µm L is the measuring length in mm			
max. load capacity	90mm				
Illumination		contour illumination: 24V/150W halogen lamp, brightness is adjustable			
		surface illumination: 24V/150W halogen lamp			
Data processing unit	display	X-Y stage travel, screen rotation			
	output	RS232C			
	function	<ul style="list-style-type: none"> measure coordinate of point measure coordinate of line measure center coordinate, radius of circle with three points measure distance between two objects measure angle with four points or two lines set origin of coordinate coordinate transform set midpoint of coordinate 			
Power supply		110/220V, 50/60Hz			
Dimension (L×W×H)		550×770×1100mm			
Weight		135kg			

STANDARD DELIVERY

Main unit	1 pc
10X lens with half-reflection mirror and oblique illuminator mirror	1 pc
Overlay chart clip	4 pcs
Foot-switch	1 pc
Anti-dust cover	1 pc
USB cable	1 pc

OPTIONAL ACCESSORY

20X lens with half-reflection mirror and oblique illuminator mirror	ISP-Z3015-LENS20X
50X lens with half-reflection mirror	ISP-Z3015-LENS50X
100X lens with half-reflection mirror	ISP-Z3015-LENS100X
Rotary table	ISP-Z3015-TABLE
Overlay chart	ISP-Z3015-CHART
Holder with clamp	ISP-Z3015-HOLDER
Swivel center support	ISP-Z3015-SUPPORT
V-block with clamp	ISP-Z3015-VBLOCK
50mm reading scale	ISP-Z3015-SCALE50
300mm calibration scale	ISP-Z3015-RULE
Blue filter	ISP-Z3015-FILTER
Demo sample	ISP-Z3015-DEMO

QUICK MEASUREMENT SYSTEM (WITHOUT STITCHING)



- One or more workpieces can be measured by one step operation
- Place workpieces at any position
- Focus and measure automatically



QMS-A110

SPECIFICATION

Code	QMS-A110	
Optical lens	low-distortion lens, single-field telecentric Ø100mm	
View field range	100×80mm	
Measurement range (X×Y)	98×78mm	
Measurement accuracy *	±3µm	
Repeatability	±1µm	
Max.weight of workpiece	5kg	
Measurement time	<2s	
Measurement data	2D measurement	
Power supply	220V, 50Hz, 600W	
Illumination system	back light	telecentric illuminator, green light
	ring light	4-zone circular white high light circular (directional) low-angle green light (electric)
	coaxial light (optional)	vertical illuminator, white light
Environmental requirement	temperature: 20°C±2°C, relative humidity: 30%~80%, vibration: <0.002g, less than 15Hz	
Dimension (L×W×H)	580×235×790mm	
Weight	40kg	

* The optimum temperature is 20°C±1°C
Within 80×64mm, on focal position and environment temperature at 20°C±1°C

STANDARD DELIVERY

Main unit	1 pc
Computer	1 pc
Software	1 pc

OPTIONAL ACCESSORY

Coaxial light illumination	QMS-23-A3
Data transmission function of software	QMS-23-D1
CAD import function of software	QMS-23-C1
Foot-switch	QMS-43-FS1

Software (included)

- Automatically measure widths, holes, rings, angles at the same time, simple and efficient.
- Measuring result can be stored automatically. OK items and NG items can be counted automatically.



VISION MEASURING SYSTEMS



ISD-V250A

computer is included

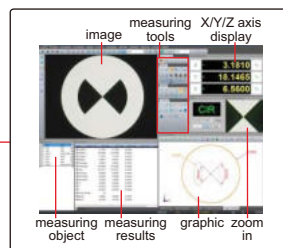

lens with coaxial light (optional, must be installed in factory)

SPECIFICATION

Code	ISD-V150A	ISD-V250A	ISD-V300A
Measuring range (X×Y×Z)	150×100×150mm	250×150×150mm	300×200×150mm
Stage size	354×228mm	450×280mm	500×330mm
Glass stage size	210×160mm	306×196mm	350×250mm
Resolution of X/Y/Z axis	0.5μm		
Accuracy of X/Y axis	≤(3.5+L/100)μm (L is the measuring length in mm)		
Repeatability of X/Y axis	2μm		
Objective	0.7X~4.5X (zoom)		
Working distance	92mm		
Magnification	33X~195X (on 19" monitor)		
Camera	1/3" color CCD, 0.3M pixel		
Illumination	surface and contour with adjustable LED		
Max. height of workpiece	150mm		
Max. weight of workpiece	20kg		
Operation system	Windows 7/8/10		
Drive method	manual		
Power supply	110/220V, 50/60Hz		
Dimension (L×W×H)	560×540×850mm	760×600×900mm	760×600×900mm
Weight	100kg	120kg	140kg

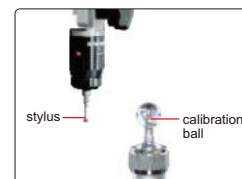

probe (optional), includes Ø2mm and Ø3mm styli, Ø25mm calibration ball, measuring accuracy is 10μm

STANDARD DELIVERY

Main unit	1 pc
Computer	1 pc
Calibration glass chart	1 pc
Clay	1 pc
Foot switch	1 pc
Anti-dust cover	1 pc

OPTIONAL ACCESSORY

0.5X auxiliary objective	Code: ISD-V-OB05X Working distance: 175mm Magnification: 16.5~97.5X (on 19" monitor)
2X auxiliary objective	Code: ISD-V-OB2X Working distance: 36mm Magnification: 66~390X (on 19" monitor)
Probe	Code: ISD-V-PROBE Includes Ø2mm and Ø3mm styli, Ø25mm calibration ball
Vision measuring system with coaxial light lens (with computer)	Code ISD-V150ACL, ISD-V250ACL, ISD-V300ACL
Office software	Code 7313-OFFICE

SOFTWARE

- Operation system: Windows 7/8/10
- Language: English
- Single measuring tools:

- measure coordinate of point
- measure center coordinate and axis length of ellipse
- measure length of open curve
- measure distance of two elements

- measure center coordinate, diameter and area of circle
- measure length, width and area of rectangle
- measure length and area of closed curve

- measure distance between two points
- measure length, width and diameter of key slot
- measure angle of two lines

- measure length and diameter of arc
- measure width and diameter of ring
- measure focus distance of urface

To be continued

Continued from previous page

■ **Combined measuring tools:**

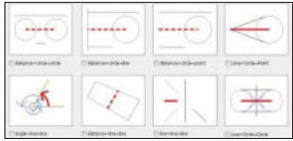

measure distance and angle of two elements

■ **Focus indicator:**

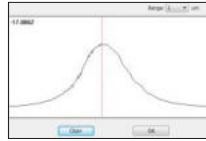

■ **Coordinate transfer:**

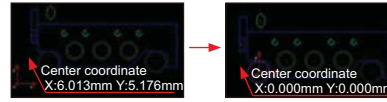

■ **Data export to CAD, EXCEL and WORD**

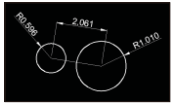

CAD

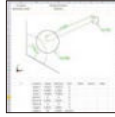

EXCEL



WORD

■ **Edge-detection:**

Point tool



Box tool



Circle tool

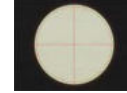

■ **Profile detection:**



■ **Contour scanning:**

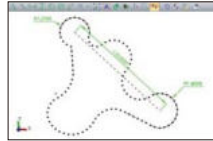

■ **CAD measuring:**



Input CAD drawing and set reference, move the stage to make the target box in the center of crosshair, then the software will do automatic measurement

CNC VISION MEASURING SYSTEMS



programmable segmented ring light (included)



ISD-V220CNCA



controller

computer is included

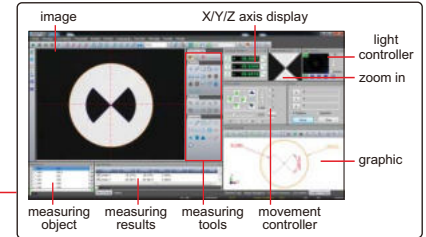

- Automatic edge-detection, focus, measuring, contour scanning, calibration, etc.
- Servo motors for X, Y, Z axis
- SPC function for large quantity measurement
- Measuring software is included

STANDARD DELIVERY

Main unit	1 pc
Software	1 pc
Computer	1 pc
24" display	1 pc
Len with coaxial light	1 pc
Controller	1 pc
Calibration glass chart	1 pc
Laser positioner	1 pc
Clay	1 pc
Anti-dust cover	1 pc

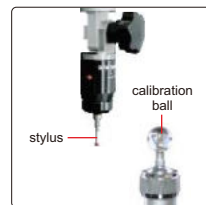

stylus

calibration ball

probe (optional), includes Ø2mm and Ø3mm styli, Ø25mm calibration ball, measuring accuracy is 10µm



laser probe (optional) measuring accuracy is 5µm

To be continued

Continued from previous page

SPECIFICATION

Code (manual zoom lens)	ISD-V220CNCA	ISD-V270CNCA	ISD-V370CNCA
Measuring range (X*Y*Z)	220×120×150mm	270×170×150mm	370×270×150mm
Stage size	450×280mm	500×330mm	606×466mm
Glass stage size	306×196mm	350×250mm	450×350mm
Resolution of X/Y/Z axis	0.5µm		
Accuracy of X/Y axis	≤(2.5+L/100)µm (L is the measuring length in mm)		≤(3.5+L/100)µm (L is the measuring length in mm)
Repeatability of X/Y axis	2µm		
Objective	0.7X~4.5X (zoom)		
Working distance	92mm		
Magnification	33.0X~208.6X (on 24" monitor)		
Camera	Giga-bit network camera		
Illumination	surface	coaxial light, programmable segmented ring light	
	contour	adjustable LED light	
View field (diagonal length)	1.5~10.8mm		
Max. height of workpiece	150mm		
Max. weight of workpiece	30kg		
Operation system	Windows 7/8/10		
Drive method	automatic		
Power supply	220V, 50/60Hz		
Dimension (L*W*H)	760×600×900mm	760×600×900mm	970×670×940mm
Weight	146kg	168kg	266kg

OPTIONAL ACCESSORY

0.5X auxiliary objective	Code: ISD-V-OB05X Working distance: 175mm Magnification: 16.5~104.3X (with manual zoom lens, on 24" monitor)
2X auxiliary objective	Code: ISD-V-OB2X Working distance: 36mm Magnification: 66~417.2X (with manual zoom lens, on 24" monitor)
Probe	Code: ISD-V-PROBE Includes Ø2mm and Ø3mm styli, Ø25mm calibration ball
Laser probe	Code: ISD-V-LASER
Office software	Code: 7313-OFFICE
Desk	Code: ISD-V-DESK



SOFTWARE

- **Operation system:** Windows 7/8/10
- **Language:** English
- **Single measuring tools:**

- measure coordinate of point
- measure center coordinate and axis length of ellipse
- measure length of open curve
- measure distance of two elements

- measure center coordinate, diameter and area of circle
- measure length, width and area of rectangle
- measure length and area of closed curve

- measure distance between two points
- measure length, width and diameter of key slot
- measure angle of two lines

- measure length and diameter of arc
- measure width and diameter of ring
- measure focus distance of surface

■ **Combined measuring tools:**

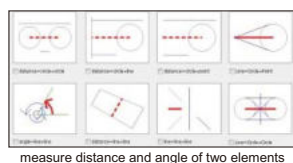

■ **Focus indicator:**

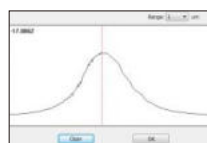

■ **Coordinate transfer:**



■ **Data export to CAD, EXCEL and WORD**

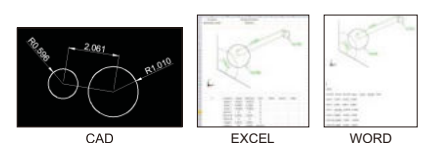

■ **Profile detection:**



■ **Edge-detection:**

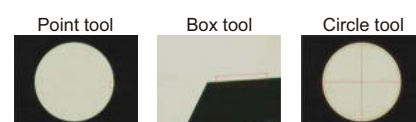

■ **Contour scanning:**

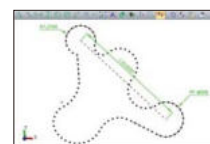

■ **CAD measuring:**



Input CAD drawing and set reference, move the stage to make the target box in the center of crosshair, then the software will do automatic measurement

JIG SET FOR VISION MEASURING SYSTEMS CODE ISY-700

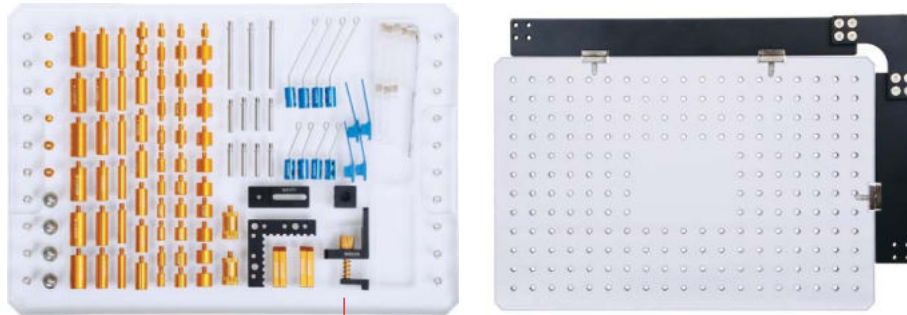







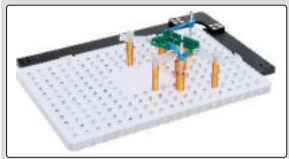

acrylic tray (included)

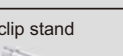
ISY-700

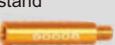
application example

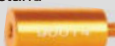

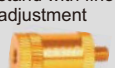
Product	Code	Size (mm)	Quantity
 clip	ISY-700-90001	7×34	4
 clip	ISY-700-90002	Ø1.5×24	4
	ISY-700-90003	Ø1.5×50	4
 clip stand	ISY-700-90004	Ø4×20	8
	ISY-700-90005	Ø4×46	3
 spherical support head	ISY-700-90006	—	4
 stand	ISY-700-90007	Ø6×10	6
	ISY-700-90008	Ø6×25	6
	ISY-700-90019	Ø6×6	3
 stand	ISY-700-90009	Ø9×7	3
	ISY-700-90010	Ø9×10	6
	ISY-700-90011	Ø9×20	6
	ISY-700-90012	Ø9×25	6
 stand	ISY-700-90013	Ø12×10	6
	ISY-700-90014	Ø12×25	6
 stand for slice parts	ISY-700-90015	Ø6×10	4
	ISY-700-90016	Ø9×10	4
	ISY-700-90017	Ø12×10	4
 stand with fine adjustment	ISY-700-90018	Ø12×20~25	2

Product	Code	Size (mm)	Quantity
 adapter for square support	ISY-700-90020	—	2
 clamping screw	ISY-700-90021	—	4
 L-shaped positioning plate	ISY-700-90022	50×50×6	1
 sliding support plate	ISY-700-90023	30×12×5	4
 square support	ISY-700-90024	20×16×16	1
 base for square support	ISY-700-90025	45×16×6	1
 spring stand	ISY-700-90026	—	1
 acrylic sliding support plate	ISY-700-90028	45×12×5	8
 wrench	ISY-700-90029	M3	1
 acrylic base plate	ISY-700-90030	300×200×12	1



TOOLMAKER MICROSCOPE

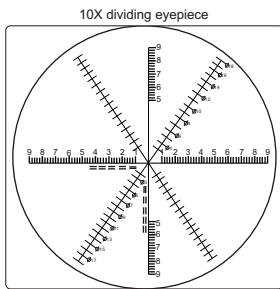

The horizontal and vertical scale lines are used for length measurement, the graduation is 0.2mm. The two diagonals scale lines are used for diameter measurement, the graduation is 1mm (when using 1X objective).

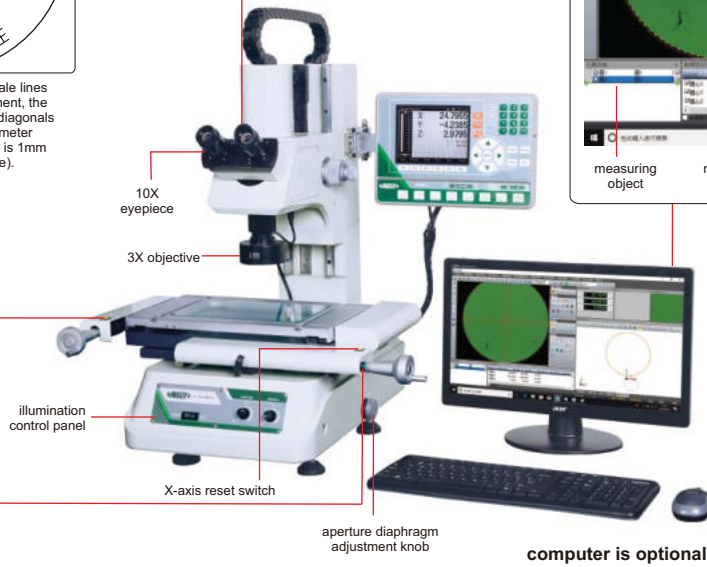
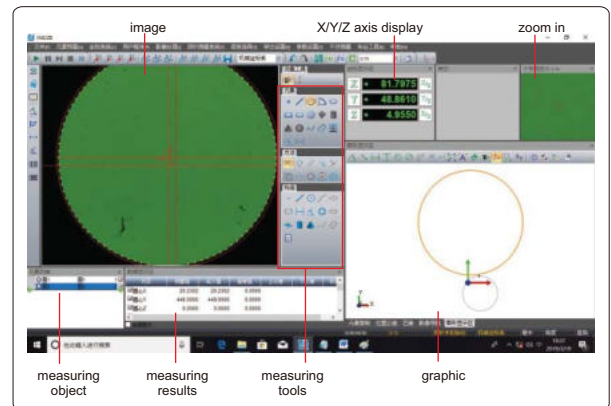

Y-axis reset switch



laser positioning switch

computer is optional

SPECIFICATION

Code	ISD-VMM215 (binocular)
X/Y axis travel	200×100mm
Z axis travel	150mm
Metal stage size	404×228mm
Glass stage size	260×160mm
Resolution of X/Y/Z axis	0.5µm
Accuracy of X/Y axis	≤(2.5+L/100)µm (L is the measuring length in mm)
Repeatability	2µm
Camera	1/3" color CCD, 0.3M pixel
Optical magnification	30X (with 3X objective)
Image magnification	114X (on 19" monitor)
Illumination	surface and contour with adjustable LED
Max. weight of workpiece	25kg
Power supply	100V~240V, 50/60Hz
Operation system	Windows 7/8/10
Drive method	manual
Dimension (L×W×H)	540×667×850mm
Weight	110kg

DATA PROCESSING UNIT

Output	RS232
Function	simple measuring tools
	measure coordinate of points
	measure lines
	measure center coordinate, radius of circle with three points
	measure distances between two objects
	measure angles
	set origin of coordinate
	skew and calibrate the workpiece
	measure rectangle (including length, width, perimeter and center coordinate)
	measure thread (including thread diameter, screw pitch, screw angle)
	measure slot (including center coordinate, length, width)

STANDARD DELIVERY

Main unit	1 pc
Video card with dongle	1 pc
Software disc	1 pc
Calibration glass chart	1 pc
Demo sample	1 pc
Foot switch	1 pc
3X objective	1 pc

OPTIONAL ACCESSORY

1X objective	ISD-VMM-LENS1X
5X objective	ISD-VMM-LENS5X
10X objective	ISD-VMM-LENS10X
Toolmaker microscopes (with computer)	Code: ISD-VMM215A (binocular)

To be continued

Continued from previous page

SOFTWARE

- **Operation system:** Windows 7/8/10
- **Language:** English
- **Single measuring tools:**

- measure coordinate of point
- measure center coordinate and axis length of ellipse
- measure length of open curve
- measure distance of two elements

- measure center coordinate, diameter and area of circle
- measure length, width and area of rectangle
- measure length and area of closed curve

- measure distance between two points
- measure length, width and diameter of key slot
- measure angle of two lines

- measure length and diameter of arc
- measure width and diameter of ring
- measure focus distance of surface

■ **Combined measuring tools:**

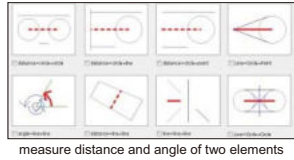

■ **Focus indicator:**



■ **Coordinate transfer:**

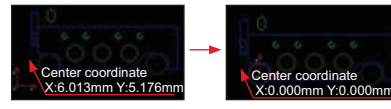

■ **Data export to CAD, EXCEL and WORD**

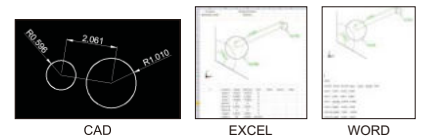

■ **Profile detection:**



■ **Edge-detection:**



■ **Contour scanning:**

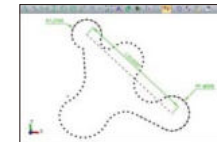

■ **CAD measuring:**

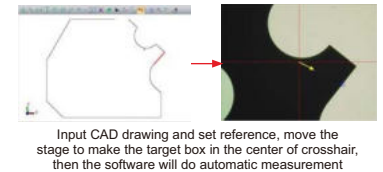

**AUTO FOCUS DIGITAL MICROSCOPE (LARGE VIEW FIELD)
CODE 5302-AF105**

- MEASUREMENT
- AUTO FOCUS
- TAKE PICTURES AND VIDEOS



- 1080P high-definition image
- Auto focus camera
- Take pictures and videos, saved to memory card
- Connected to TV by HDMI port
- Automatic exposure and white balance
- Brightness, contrast ratio, gain are adjustable
- Display cross hair (blue/green/red/yellow/black/brown colors)
- Built-in software without computer, operation by mouse

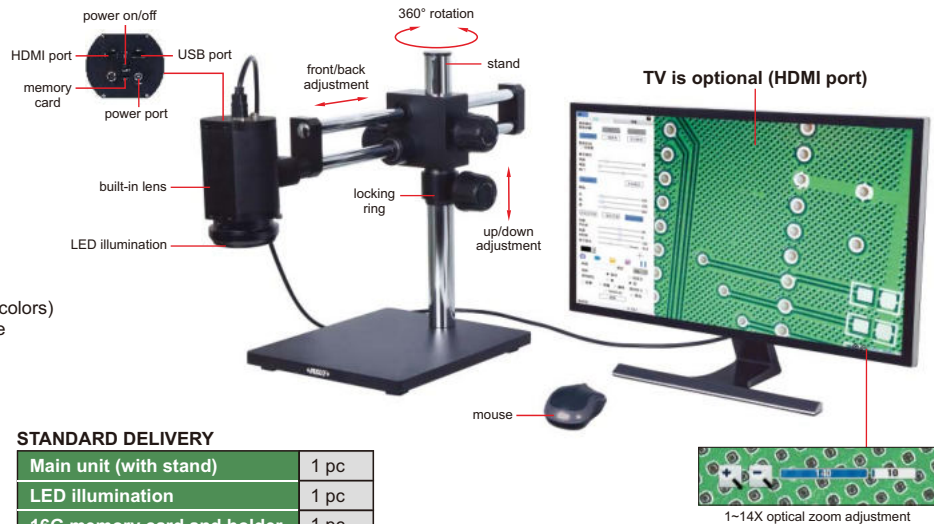

SPECIFICATION

Magnification	1.8X~27.5X (on 28" TV)
Sensor	1/2.8" CMOS
Pixel	2M
Resolution	1920×1080
Frame rate	60fps
Auto focus distance	100mm~∞
Output	HDMI
Power supply	power adapter
Dimension (L×W×H)	500×280×410mm
Weight	17kg

STANDARD DELIVERY

Main unit (with stand)	1 pc
LED illumination	1 pc
16G memory card and holder	1 pc
Mouse	1 pc
HDMI cable (for TV)	1 pc
Power adapter	2 pcs

Focus distance	Adjustable magnification (on 28" TV)	View field	Measuring accuracy
100mm	4.5~27.5X	24×14~161×90mm	0.02mm
150mm	3~21X	30×17~240×128mm	0.02mm
200mm	2.3~17.5X	38×20~305×176mm	0.02mm
250mm	2~15X	42×24~320×210mm	0.02mm
270mm	1.8~14.4X	43×25~378×240mm	0.02mm

MEASURING SOFTWARE (INCLUDED)

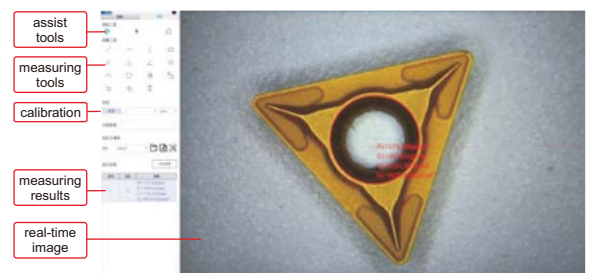

3D MOTORIZED ROTATION MICROSCOPE (WITH DISPLAY) CODE 5301-D400

SUITABLE TO CHECK CONVEX
OBJECTS AND WALL OF HOLE

TAKE PICTURES
AND VIDEOS

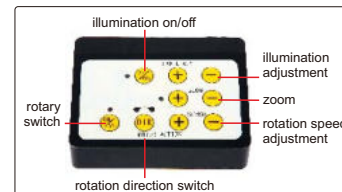
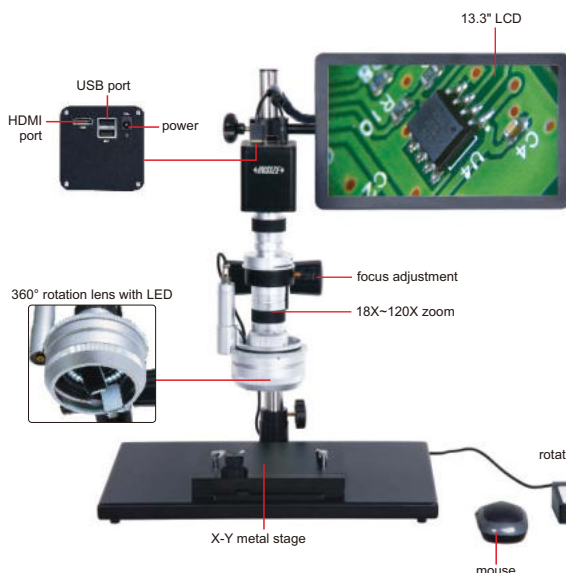
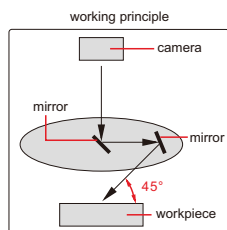

- 1080P high-definition 3D image
- Take pictures and videos, save to USB flash disk
- Automatic white balance and exposure
- Brightness, contrast ratio and gain are adjustable

SPECIFICATION

Magnification	18X~120X
View field	2.4×1.5mm~16×9mm
Focus distance	20mm
View angle	45°
Sensor	1/2.8" CMOS
Pixel	2M
Resolution	1920×1080
Frame rate	60fps
Output	HDMI
Rotation speed	2~5RPM
Power supply	110/220V, 50/60Hz
Dimension (L×W×H)	570×300×430mm
Weight	10kg

STANDARD DELIVERY

Main unit	1 pc
Rotation controller	1 pc
X-Y metal stage	1 pc
16G USB flash disk	1 pc
White/black plate	1 pc
Mouse	1 pc
Power adapter	2 pcs

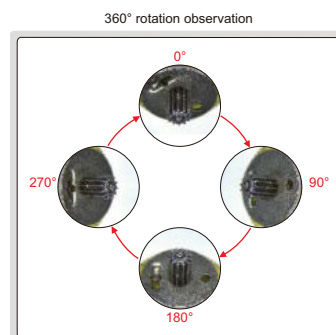

3D MANUAL ROTATION MICROSCOPE (WITH DISPLAY) CODE 5313-S407

SUITABLE TO CHECK CONVEX OBJECTS
AND WALL OF HOLES

TAKE PICTURES
AND VIDEOS

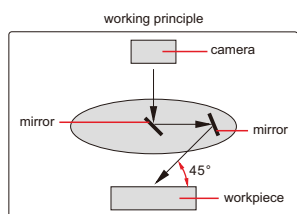

SPECIFICATION

Magnification	18X~120X
View field	2.4×1.5mm~16×9mm
Focus distance	20mm
View angle	45°
Sensor	1/2.8" CMOS
Pixel	2M
Resolution	1920×1080
Frame rate	60fps
Output	HDMI
Power supply	220V, 50/60Hz
Dimension (L×W×H)	570×300×430mm
Weight	10kg

STANDARD DELIVERY

Main unit	1 pc
X-Y metal stage	1 pc
16G USB flash disk	1 pc
White/black plate	1 pc
Mouse	1 pc
Power adapter	2 pcs

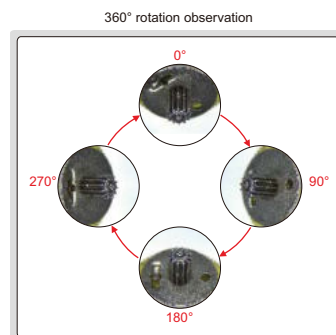

DIGITAL MEASURING MICROSCOPE (WITH DISPLAY)

MEASUREMENT

BUILT-IN SOFTWARE
WITHOUT COMPUTER

TAKE PICTURES

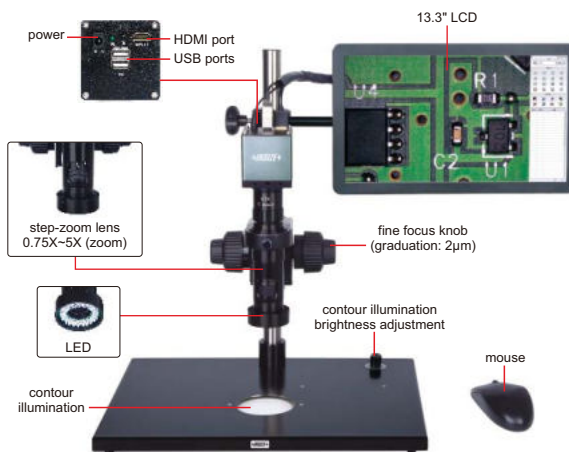

- 1080P high-definition image
- Built-in software without computer, operation by mouse
- Take pictures, saved to USB flash disk
- Measurement results can be output to Excel
- Automatic white balance and exposure
- Brightness, contrast ratio, gain are adjustable

ISM-DL301 (with contour illumination)

SPECIFICATION

Code	ISM-DL301 (with contour illumination)
Magnification	15X~100X
Sensor	1/2" CMOS
Pixel	2M
Resolution	1920×1080
Frame rate	60fps
Output	HDMI
Power supply	power adapter
Dimension (L×W×H)	570×300×430mm
Weight	6.5kg



STANDARD DELIVERY

Main unit	1 pc
0.5X camera adapter	1 pc
1X auxiliary objective	1 pc
Calibration plate	1 pc
16G USB flash disk	1 pc
White/black plate	1 pc
Mouse	1 pc
HDMI cable	1 pc
Power adapter	3 pcs

MAGNIFICATION AND MEASURING ACCURACY

Objective magnification	Image magnification	Measuring accuracy
0.75X	15X	±8µm
1X	20X	±7µm
1.5X	30X	±6µm
2X	40X	±6µm
2.5X	50X	±6µm
3X	60X	±5µm
3.5X	70X	±5µm
4X	80X	±4µm
4.5X	90X	±4µm
5X	100X	±4µm

OPTIONAL ACCESSORY

1X camera adapter	ISM-DL-CA1X
2X auxiliary objective	ISM-DL-OB2X
X-Y glass stage (travel: 74×60mm)	ISM-DL-STAGE
X-Y metal stage	ISM-DL-STAGE1
LED light	see details
Auxiliary objective	see details

MAGNIFICATION, FOCUS DISTANCE AND VIEW FIELD

Auxiliary Objective	Specification	Camera adapter	
		0.5X (included)	1X (optional)
1X (included)	Magnification	15~100X	30~200X
	Focus distance	70±2mm	70±2mm
	View field	16×11~2.5×1.6mm	7.8×5.3~1.2×0.8mm
2X (optional)	Magnification	30~200X	60~400X
	Focus distance	29±2mm	29±2mm
	View field	7.8×5.3~1.2×0.8mm	3.8×2.7~0.6×0.4mm

SOFTWARE (INCLUDED)

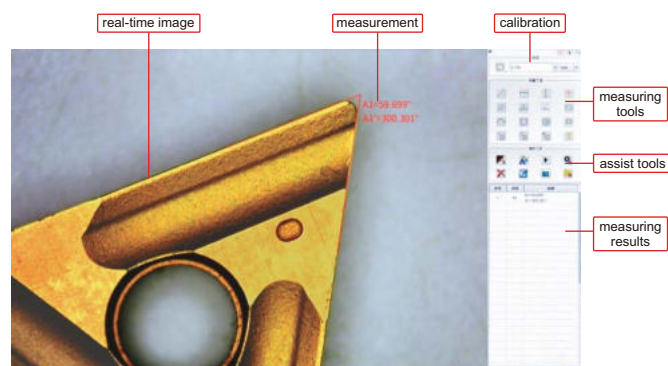

DIGITAL MEASURING MICROSCOPE CODE 5307-ID100A



ELECTRONIC MAGNIFICATION
FEEDBACK LENS

BUILT-IN SOFTWARE
WITHOUT COMPUTER

- Electronic magnification feedback lens: when the objective lens magnification is changed manually, the software automatically selects the corresponding pre-calibration data and calibration is not needed
- Two methods of LED brightness adjustment, knob adjustment and software adjustment
- Built-in software without computer, operated by mouse
- Take pictures, save to USB flash disk
- Measuring results can be sent to Excel

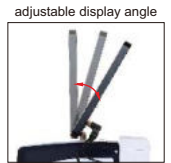
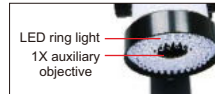

SPECIFICATION

Sensor	1/2" CMOS
Pixel	2M
Resolution	1920×1080
Magnification	12~77X
Focus distance	100mm
View field	2.7×1.9~17.5×11.9mm
Max workpiece height	60mm
Frame rate	60fps
Output	USB/HDMI
Power supply	power adapter
Dimension (L×W×H)	610×610×660mm
Weight	4.5kg

STANDARD DELIVERY

Main unit	1 pc
Calibration plate	1 pc
Power adapter	1 pc
Mouse	1 pc
16G USB flash disk	1 pc

OPTIONAL ACCESSORY

0.5X auxiliary objective	5307-ID100A-OB05X
0.75X auxiliary objective	5307-ID100A-OB075X
2X auxiliary objective	5307-ID100A-OB2X

MAGNIFICATION AND MEASURING ACCURACY

Objective magnification	Magnification	Measuring accuracy
0.7X	12X	±9μm
1X	17X	±9μm
1.5X	26X	±8μm
2X	35X	±7μm
2.5X	43X	±7μm
3X	51X	±7μm
3.5X	60X	±6μm
4X	68X	±6μm
4.5X	77X	±5μm

DIGITAL MICROSCOPE



MEASUREMENT

TAKE PICTURES
AND VIDEOS

- Independent control of vertical illumination and diffuse illumination
- Back focus adjustment extends working distance
- Take pictures and videos, save to memory card

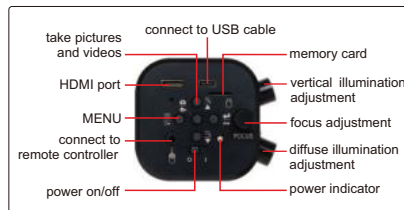

5309-DM50

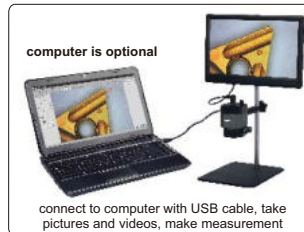

SPECIFICATION

Code	5309-DM50
Arm type	straight
Sensor	1/2.8" CMOS
Pixel	2M
Resolution	1920×1080
Exposure	real-time auto, single auto, manual adjustment
White balance	real-time auto, single auto, manual RGB adjustment
Record format	pictures: JPG videos: MOV
Record media	memory card
Working distance	45~169mm
Magnification	9~41X
View field	7.6×4~38.5×21.7mm
Power supply	DC12V 3A

STANDARD DELIVERY

Main unit	1 pc
Memory card and holder	1 pc
Plastic calibration rule (graduation 1mm)	1 pc
White/black plate	1 pc
Remote controller	1 pc
USB cable	1 pc
Measuring software	1 pc
Power adapter	1 pc

USE COMPUTERS, OPTIONAL

Image magnification	View field	Measuring accuracy
9.0X	38.5×21.7mm	±0.02mm
13.0X	26.6×15.0mm	±0.02mm
17.0X	20.5×11.7mm	±0.02mm
22.0X	16.0×9.0mm	±0.02mm
28.5X	11.9×6.3mm	±0.02mm
34.0X	9.8×5.5mm	±0.01mm
41.0X	7.6×4.1mm	±0.01mm

MINI DIGITAL MICROSCOPE (ECONOMIC TYPE) CODE 5311-M710

TAKE PICTURES AND VIDEOS

BUILT-IN LITHIUM BATTERY

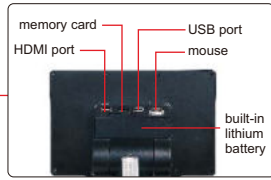

8G memory card and holder (included)



infrared ray remote controller (included)

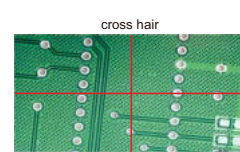

cross hair

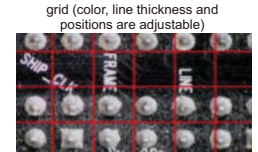

grid (color, line thickness and positions are adjustable)

SPECIFICATION

Display resolution	1024×600
Sensor	1/3" CMOS
Sensor resolution	1280×960
Single pixel size	2µm×2µm
Frame rate	60fps/30fps
Magnification	1X~16X
White balance	auto/manual (10 levels RGB)/calibration
Exposure control	AE lock/exposure compensation (10 levels)
Image control	contrast/saturation/sharpness
Record media	memory card
Output	HDMI
Power supply	built-in lithium battery/power adapter
Dimension(L×W×H)	174×200×350mm
Weight	1.5kg

STANDARD DELIVERY

Main unit	1 pc
USB cable	1 pc
HDMI cable	1 pc
IR remote controller	1 pc
8G memory card and holder	1 pc
Plastic calibration rule	1 pc
Power adapter	1 pc

SOFTWARE FOR COMPUTER (included)

- Language: Chinese (Simplified), English
- Operation system: Windows 7/8/8.1/10 (64bit)
- Port: USB2.0 or above
- Measuring accuracy: 0.02mm

- + point counting
- center distance of 2 circles
- straight line length
- radius of a circle
- continuous line length
- cross line
- area of a rectangle
- double cross line
- area of a polygon
- angle
- distance between 2 lines
- arc
- point-line distance
- distance between parallel lines
- distance between line and first parallel line
- center distance of concentric circle
- radius of a 2-point circle
- radius of a 3-point circle



Screen freezing:

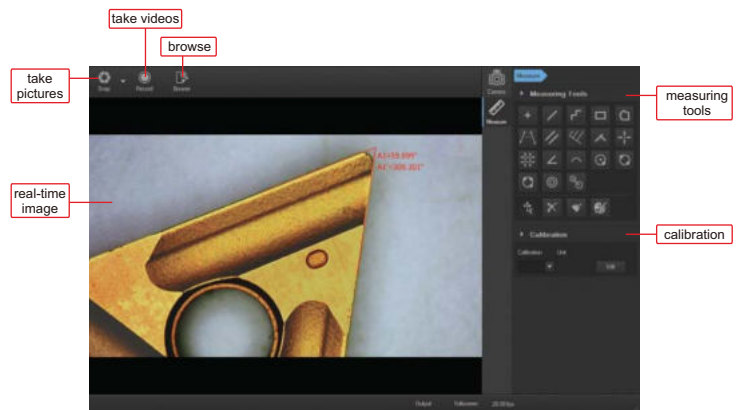
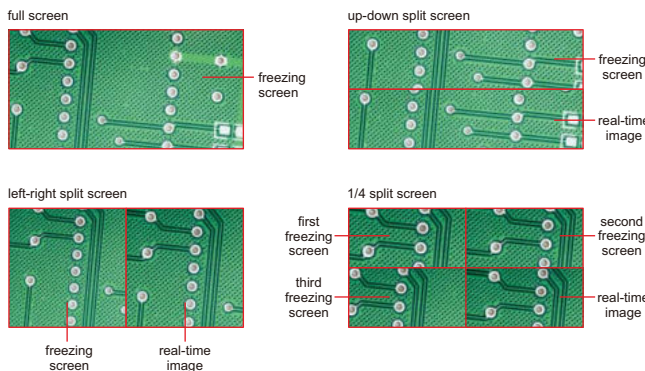

DIGITAL MEASURING MICROSCOPE

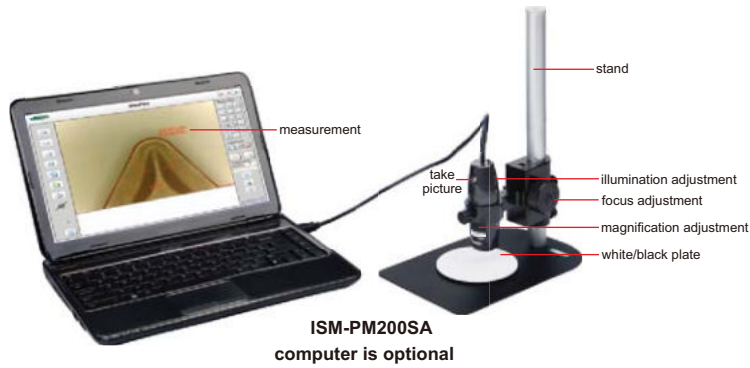

- Can take pictures and videos
- Supplied with software
- Calibration rules (graduation 0.1 and 1mm) are included
- With focus support

ISM-PM200SA
computer is optional

SPECIFICATION

Code	ISM-PM200SA
Magnification	10X-200X
Stand	standard
Pixel	2M (resolution: 1600×1200)
Illumination	built-in adjustable LED
Power supply	USB 2.0 cable (voltage required: 5±0.1V)



filter (optional)

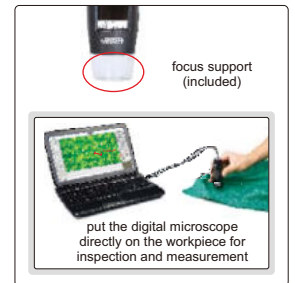

MAGNIFICATION, FOCUS DISTANCE, VIEW FIELD AND ACCURACY

Magnification	Focus distance	View field (mm)	Accuracy
50X	21mm	8.1×6.4	30μm
100X	13mm	3.9×3.1	15μm
150X	16mm	2.6×2.1	10μm
200X	19mm	1.8×1.5	8μm

OPTIONAL ACCESSORY

Green filter	ISM-PM-GREEN
Yellow filter	ISM-PM-YELLOW
Blue filter	ISM-PM-BLUE

SOFTWARE

- Language: English, Japanese, Korean, German, Turkey, Portuguese, Chinese
- Operation system: Windows 7/8/XP/Vista
- Measurement tools:

- measure length of line or distance between two points
- measure distance between point and line
- measure distance between two parallel lines
- measure length of continuous line
- measure area of rectangle
- measure radius, girth and area of circle
- measure radius, length and angle of arc
- measure distance between two circles
- measure angle with three points
- measure angle with two lines
- add text
- add number with circle

Edge detection measurement tools:

- detect line automatically, and calculate length
- detect arc automatically, and calculate radius, angle and arc length
- detect two lines automatically, and calculate angle
- detect circle automatically, and calculate radius, girth and area
- detect two parallel lines automatically, and calculate distance

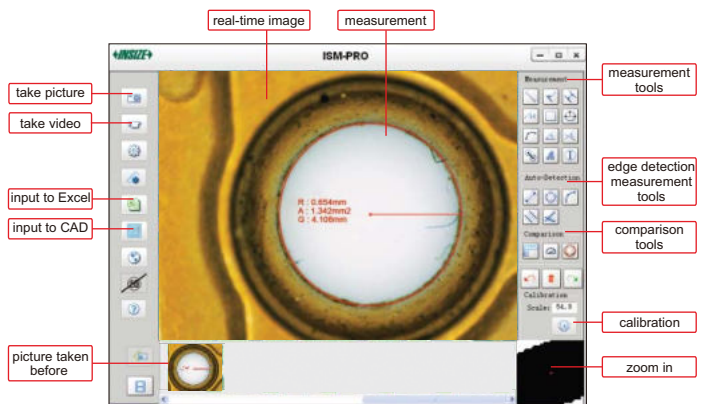

Comparison tools:

Create line, angle or circle with desired size, to compare with workpieces.

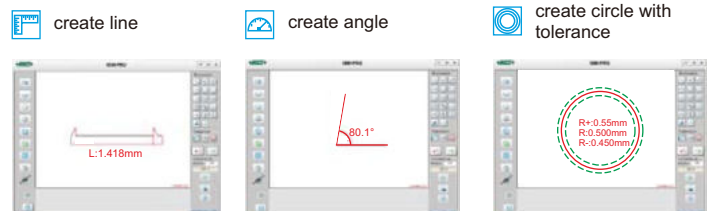

Data export to CAD or Excel:



WiFi DIGITAL MEASURING MICROSCOPE CODE ISM-WF200



plastic calibration rule
(graduation 1mm, included)

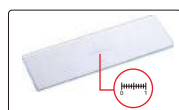

glass calibration rule
(graduation 0.1mm, included)



software CD
(included)

- Maximum working distance is 5m under WiFi mode
- Can be connected to multiple iPads, Android devices or computers at the same time under WiFi mode
- Take pictures and videos
- Supplied with software

SPECIFICATION

Magnification	10X~200X
Pixel	1.3M (resolution: 1280x1024)
Illumination	built-in adjustable LED
Power supply	built-in rechargeable battery

STANDARD DELIVERY

Microscope	1 pc
Focus support ring for 80X/150X	1 pc
Focus support ring for 60X/200X	1 pc
Glass calibration rule (graduation 0.1mm)	1 pc
Plastic calibration rule (graduation 1mm)	1 pc
Software and USB cable	1 pc
AC/DC adapter	1 pc

OPTIONAL ACCESSORY

Stand	ISM-PM-STAND
Green filter	ISM-PM-GREEN
Yellow filter	ISM-PM-YELLOW
Blue filter	ISM-PM-BLUE



stand (code
ISM-PM-STAND, optional)



filter (optional)

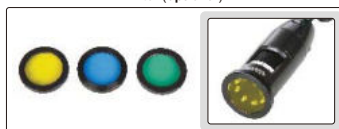

connected to iPad
by WiFi



connected to Android
device by WiFi



connected to computer by WiFi



connected to computer by USB cable

MAGNIFICATION, FOCUS DISTANCE, VIEW FIELD AND ACCURACY

Magnification	Focus distance	View field	Accuracy
50X	21mm	8.1×6.4mm	30μm
100X	13mm	3.9×3.1mm	15μm
150X	16mm	2.6×2.1mm	10μm
200X	19mm	1.8×1.5mm	8μm

1 Software ISM-PAD (for iPad by WiFi)

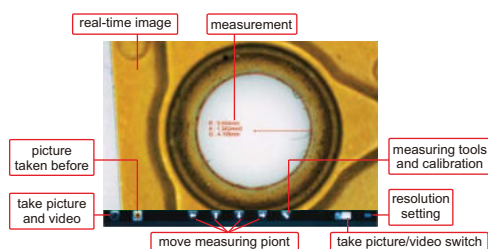

2 Software ISM-APK (for Android devices by WiFi)

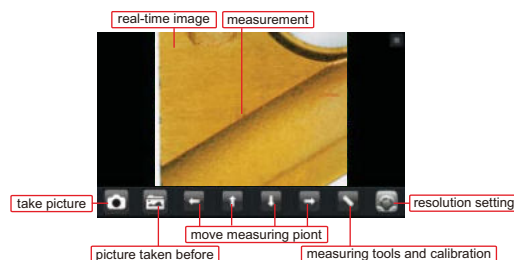

3 Software ISM-WF Partner (for computer by WiFi)

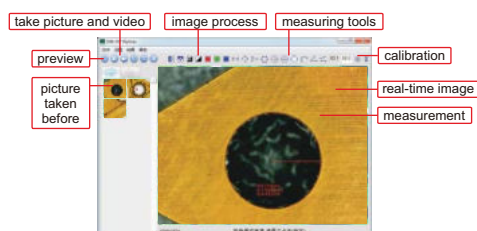

4 Software ISM-PRO (for computer by USB cable)

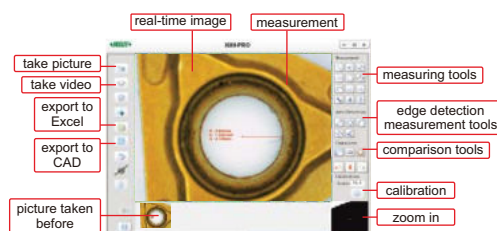

INDUSTRIAL MICROSCOPES



- Infinite optical system, polarization observation, dark field observation
- Kohler illumination system provides uniform illumination field
- Objective 50X is spring type

STANDARD DELIVERY

Main unit	1 pc
Anti-dust cover	1 pc

SPECIFICATION

Code	5101-M500 (bright field objectives)				5101-M500BD (bright & dark field objectives)			
Illumination	6V/30W halogen lamp, brightness is adjustable				12V/50W halogen lamp, brightness is adjustable			
Objective (infinite plan achromatic)	bright field objectives				bright & dark field objectives			
	5X	10X	20X	50X	5X	10X	20X	50X
Working distance	26.1mm	20.2mm	8.80mm	3.68mm	9.70mm	9.30mm	7.23mm	2.50mm
Numerical aperture	0.12	0.25	0.40	0.70	0.12	0.25	0.40	0.70
Magnification	50X~500X							
Eyepiece (wide field)	10X (view field: Ø22mm)							
	double layer							
Stage	size: 160×140mm							
	travel: 35x30mm							
Pupil distance	53~75mm							
Diopter adjustment	±5 diopter (one eyepiece)							
Power supply	220V, 50/60Hz							
Dimension (L×W×H)	415×345×380mm							
Weight	14kg							

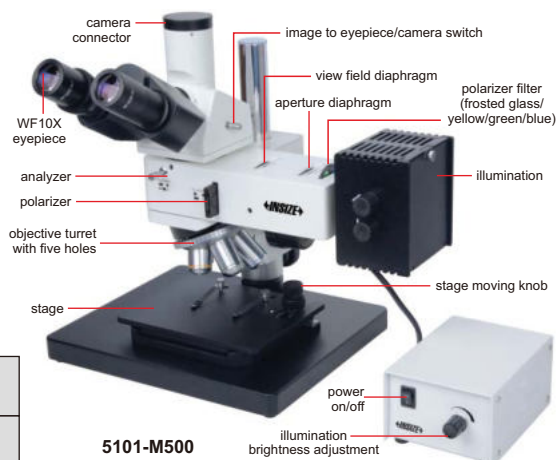

5101-M500

OPTIONAL ACCESSORY

Bright field objective (for 5101-M500)	PL40X	5101-M-OB40X
	PL60X	5101-M-OB60X
	PL80X	5101-M-OB80X
	PL100X	5101-M-OB100X
Camera adapter *		5101-M-ADAPTER
Bright & dark field objective (for 5101-M500BD)	PL40X	5101-M-BD40X
	PL60X	5101-M-BD60X
	PL80X	5101-M-BD80X
	PL100X	5101-M-BD100X
10X dividing eyepiece (0.1mm/div.)		5101-M-EPD10X
Digital camera		ISM-CM20, ISM-CM63, ISM-ZS70-S

*Digital camera must be used with camera adapter

METALLURGICAL MICROSCOPES



- Infinite optical system, polarization observation, dark field observation
- Kohler illumination system provides uniform illumination field
- Objectives 50X, 100X are spring type

STANDARD DELIVERY

Main unit	1 pc
Polarizer and analyzer	1 pc of each
Anti-dust cover	1 pc

SPECIFICATION

Code	5103-M1000 (bright field objectives)				5103-M1000BD (bright & dark field objectives)			
Illumination	6V/30W halogen lamp, brightness is adjustable				12V/50W halogen lamp, brightness is adjustable			
Objective (infinite plan achromatic)	bright field objectives				bright & dark field objectives			
	10X	20X	50X	100X	5X	10X	20X	50X
Working distance	20.2mm	8.80mm	3.68mm	0.40mm	9.70mm	9.30mm	7.23mm	2.50mm
Numerical aperture	0.25	0.40	0.70	0.85	0.12	0.25	0.40	0.70
Magnification	100X~1000X				50X~500X			
Eyepiece (wide field)	10X (view field: Ø22mm)							
	double layer							
Stage	size: 242×200mm							
	travel: 30x30mm							
Pupil distance	53~75mm							
Diopter adjustment	±5 diopter (one eyepiece)							
Power supply	220V, 50/60Hz							
Dimension (L×W×H)	614×250×394mm							
Weight	13kg							



5103-M1000

OPTIONAL ACCESSORY

Bright field objective (for 5103-M1000)	PL5X	5101-M-OB5X
	PL40X	5101-M-OB40X
	PL60X	5101-M-OB60X
	PL80X	5101-M-OB80X
Bright & dark field objective (for 5103-M1000BD)	PL40X	5101-M-BD40X
	PL60X	5101-M-BD60X
	PL80X	5101-M-BD80X
	PL100X	5101-M-BD100X
10X dividing eyepiece (0.1mm/div.)		5103-M-EPD10X
Camera adapter *		5101-M-ADAPTER
Digital camera		ISM-CM63

*Digital camera must be used with camera adapter

METALLURGICAL MICROSCOPES



VIDEO

- Infinite optical system, observation in reflected or transmitted illumination, polarizing observation and dark field observation
- Kohler illumination system provides uniform illumination field
- Objectives 40X, 60X are spring type



blue filter (included)



frosted glass filter (included)

STANDARD DELIVERY

Main unit	1 pc
Anti-dust cover	1 pc
Filter (blue/frosted glass)	1 pc of each

SPECIFICATION

Code	5102-M600 (bright field objectives)	5102-M600BD (bright & dark field objectives)
Illumination	6V/30W (transmitted), 6V/30W (reflected)	12V/30W (transmitted), 12V/50W (reflected)
Objective (infinite plan achromatic)	bright field objectives	bright & dark field objectives
	5X 10X 40X 60X	5X 10X 20X 40X
Working distance	26.1mm 20.2mm 3.98mm 3.18mm	9.70mm 9.30mm 7.20mm 3.00mm
Numerical aperture	0.12 0.25 0.60 0.70	0.12 0.25 0.40 0.70
Magnification	50X~600X	50X~400X
Eyepiece (wide field)	10X (view field: Ø22mm)	
Stage	double layer size: 210×140mm travel: 75x50mm	
Pupil distance	53~75mm	
Diopter adjustment	±5 diopter (one eyepiece)	
Power supply	220V, 50/60Hz	
Dimension (L×W×H)	456×260×498mm	
Weight	11kg	

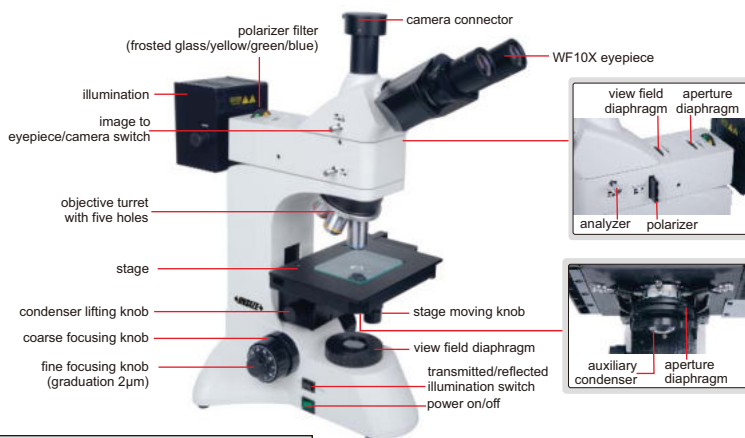

5102-M600

OPTIONAL ACCESSORY

Bright field objective (for 5102-M600)	PL20X	5101-M-OB20X
	PL50X	5101-M-OB50X
	PL80X	5101-M-OB80X
	PL100X	5101-M-OB100X
Camera adapter*		5101-M-ADAPTER
Bright & dark field objective (for 5102-M600BD)	PL50X	5101-M-BD50X
	PL60X	5101-M-BD60X
	PL80X	5101-M-BD80X
	PL100X	5101-M-BD100X
10X dividing eyepiece (0.1mm/div.)		5101-M-EPD10X
Digital camera		ISM-CM20, ISM-CM63, ISM-ZS70-S

*Digital camera must be used with camera adapter

ZOOM STEREO MICROSCOPE (PROFESSIONAL TYPE) CODE 5107-S70T



VIDEO

- Greenough optical system, clear observation, real color
- High working distance is convenient for operation
- Excellent flat image and large depth of field, make observation comfortable
- 6.7:1 large zoom ratio, allow quick observation adjustment

SPECIFICATION

Optical tube	trinocular
Eyepiece (wide field)	10X (view field: Ø22mm)
Objective	0.67X~4.5X (zoom)
Observation tube	45° trinocular tube inclination angle, built-in 0.5X adapter
Zoom ratio	6.7:1
Pupil distance	50~75mm
Diopter adjustment	-8~+5 diopter (both eyepieces)
Working distance of objective	110mm
Max. workpiece height	106mm
Illumination	adjustable LED light
Power supply	110/220V
Dimension (L×W×H)	330×300×368mm
Weight	3.5kg



white/black plate (included)



frosted glass filter (included)

STANDARD DELIVERY

Main unit	1 pc
10X eyepiece	2 pcs
Ø100mm glass plate	1 pc
Ø100mm white/black plate	1 pc
Anti-dust cover	1 pc

OPTIONAL ACCESSORY

Auxiliary objective	0.5X	5107-S70T-OB05X
	1.5X	5107-S70T-OB15X
	2X	5107-S70T-OB20X
Eyepiece	15X (view field: Ø16mm)	5107-S70T-EP15X
	20X (view field: Ø12.5mm)	5107-S70T-EP20X
LED ring light		ISM-ZS-RL
Digital camera		ISM-CM20, ISM-CM63, ISM-ZS70-S



LED ring light (optional)

PARALLEL LIGHT STEREO MICROSCOPE CODE ISM-ZS200

PARALLEL LIGHT PATH: REDUCE FATIGUE
ACCESSORIES CAN BE ADDED INTO LIGHT PATH



- Infinity parallel optical system and 20° inclined optical tube reduce fatigue
- Coaxial illumination is optional for deep holes which cannot be observed by ring light
- Aperture diaphragm is optional for large depth for field and high quality image

SPECIFICATION

Optical tube	binocular (20° inclined)
Eyepiece (wide field)	10X (view field: Ø22mm)
Objective	0.8X~8X (zoom)
Zoom ratio	1:10
Pupil distance	55~75mm
Diopter adjustment	±5 diopter (both eyepieces)
Working distance of objective	78mm
Max. workpiece height	72mm
Illumination	adjustable reflected and transmitted LED light
Power supply	110/220V, 50/60HZ
Dimension (L×W×H)	240×280×440mm
Weight	4.3kg

STANDARD DELIVERY

Main unit	1 pc
WF 10X eyepiece	2 pcs
Ø100mm glass plate	1 pc
Ø100mm white/black plate	1 pc
Anti-dust cover	1 pc

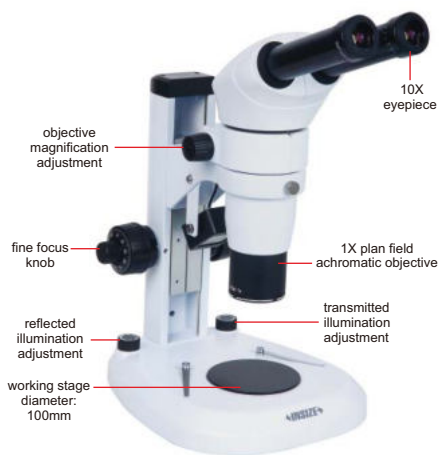

OPTIONAL ACCESSORY

Objective	0.5X achromatic objective (focus distance: 186mm)	ISM-ZS200-OB05X*
	2X plan achromatic objective (focus distance: 32.5mm)	ISM-ZS200-OB2X
	0.5X plan apochromatic objective (focus distance: 126mm)	ISM-ZS200-APO05X*
Eyepiece	WF15X (view field: Ø16mm)	ISM-ZS200-EP15X
	WF20X (view field: Ø12mm)	ISM-ZS200-EP20X
	WF30X (view field: Ø20mm)	ISM-ZS200-EP30X
Sleeve for objective		ISM-ZS30-ADAPTER
Iris diaphragm		ISM-ZS200-IRD
Optical path splitter		ISM-ZS200-OBS
Coaxial illumination		ISM-ZS200-COAXIAL
Digital camera**		ISM-CM20, ISM-CM63

* 0.5X auxiliary objective must be used with ISM-ZS30-ADAPTER

** Digital camera must be used with optical path splitter

ZOOM STEREO MICROSCOPES (ADVANCED TYPE)

LARGE ZOOM
RATIO



SPECIFICATION

Code	ISM-ZS100	ISM-ZS100T
Optical tube	binocular	trinocular
Eyepiece (wide field)	10X (view field: Ø23mm)	
Objective	0.6X~5X (zoom)	
Zoom ratio	1:8.3	
Pupil distance	55~75mm	
Diopter adjustment	±5 diopter (two eyepieces)	
Working distance of objective	115mm	
Max. workpiece height	75mm	
Illumination	adjustable reflected and transmitted LED light	
Power supply	110/220V, 50/60HZ	
Dimension (L×W×H)	260×310×490mm	
Weight	4.9kg	

STANDARD DELIVERY

Main unit	1 pc
Digital camera adapter 0.55X for ISM-ZS100T	1 pc
WF10X eyepiece	2 pcs
Ø100mm glass plate	1 pc
Ø100mm white/black plate	1 pc
Anti-dust cover	1 pc

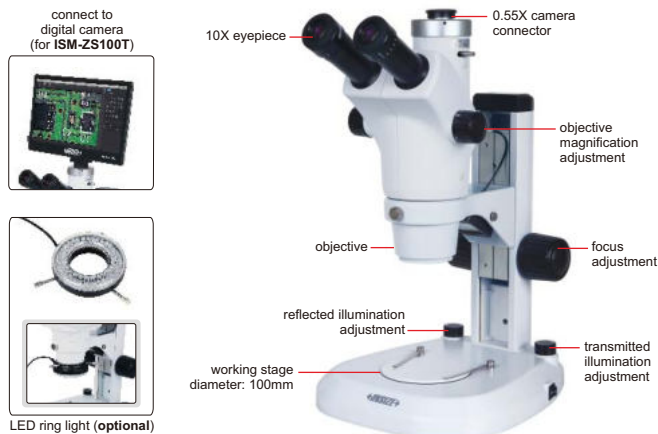

ISM-ZS100T

OPTIONAL ACCESSORY

Auxiliary objective	0.5X (focus distance: 220mm)	ISM-ZS100-OB05X*
	0.7X (focus distance: 125mm)	ISM-ZS100-OB07X
	2X (focus distance: 45mm)	ISM-ZS100-OB2X
Eyepiece	WF15X (view field: Ø16mm)	ISM-ZS100-EP15X
	WF20X (view field: Ø12mm)	ISM-ZS100-EP20X
	WF30X (view field: Ø8mm)	ISM-ZS100-EP30X
Sleeve for auxiliary objective		ISM-ZS30-ADAPTER
LED ring light		ISM-ZSRL
Digital camera adapter 1X for ISM-ZS100T		ISM-ZS100-DA
Digital camera for ISM-ZS100T		ISM-CM20, ISM-CM63, ISM-ZS70-S

* 0.5X auxiliary objective must be used with ISM-ZS30-ADAPTER

ZOOM STEREO MICROSCOPES (STANDARD TYPE)



SPECIFICATION

Code	ISM-ZS50	ISM-ZS50T
Optical tube	binocular	trinocular
Eyepiece (wide field)	10X (view field: Ø22mm)	
Objective	0.8X~5X (zoom)	
Zoom ratio	1:6.3	
Pupil distance	55-75mm (adjustable)	
Diopter adjustment	±5 diopter (two eyepieces)	
Working distance of objective	115mm	
Max. workpiece height	75mm	
Illumination	adjustable reflected and transmitted LED light	
Power supply	110/220V, 50/60Hz	
Dimension (L×W×H)	290x260x480mm	
Weight	4.9kg	

STANDARD DELIVERY

Main unit	1 pc
WF10X eyepiece	2 pcs
Ø100mm glass plate	1 pc
Ø100mm white/black plate	1 pc
Anti-dust cover	1 pc



LED ring light (optional)



ISM-ZS50

OPTIONAL ACCESSORY

Auxiliary objective	0.5X	ISM-ZS50-OB05X*
	2X	ISM-ZS50-OB2X
Eyepiece	10X dividing eyepiece (graduation 0.1mm/div.)	ISM-ZS50-EPD10X
	WF15X (view field: Ø16mm)	ISM-ZS50-EP15X
	WF20X (view field: Ø12mm)	ISM-ZS50-EP20X
LED ring light		ISM-ZS-RL
Sleeve for auxiliary objective		ISM-ZS30-ADAPTER
Digital camera for ISM-ZS50T		ISM-CM20, ISM-CM63, ISM-ZS70-S
Camera adapter 0.5X for ISM-ZS50T**		ISM-MAS-ADAPTER

* 0.5X auxiliary objective must be used with ISM-ZS30-ADAPTER

** Digital camera must be used with camera adapter 0.5X

ZOOM STEREO MICROSCOPES (WITH UNIVERSAL STAND)



SPECIFICATION

Code	5106-M50	5106-M50T
Optical tube	binocular	trinocular
Eyepiece (wide field)	10X (view field: Ø22mm)	
Objective	0.8X~5X (zoom)	
Zoom ratio	1:6.3	
Pupil distance	55~75mm	
Diopter adjustment	±5 diopter (two eyepieces)	
Working distance of objective	115mm	
Max. workpiece height	300mm	
Illumination	adjustable reflected LED ring light	
Power supply	power adapter	
Dimension (L×W×H)	790×230×430mm	
Weight	20kg	

STANDARD DELIVERY

Main unit (with stand)	1 pc
WF 10X eyepiece	2 pcs
LED ring light	1 pc
Anti-dust cover	1 pc

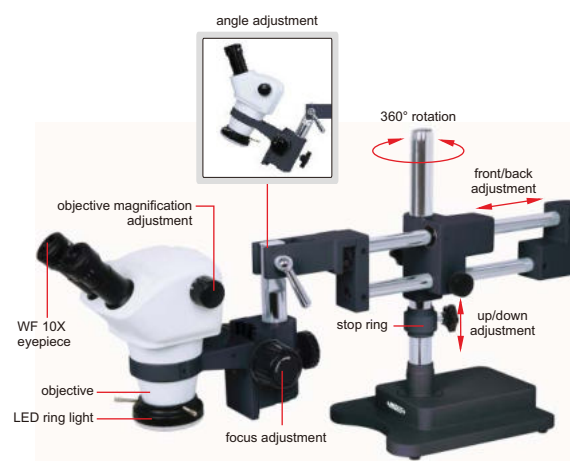

5106-M50

OPTIONAL ACCESSORY

Auxiliary objective	0.5X	ISM-ZS50-OB05X*
	2X	ISM-ZS50-OB2X
Eyepiece	10X dividing eyepiece (0.1mm/div.)	ISM-ZS50-EPD10X
	WF15X (view field: Ø16mm)	ISM-ZS50-EP15X
	WF20X (view field: Ø12mm)	ISM-ZS50-EP20X
Sleeve for auxiliary objective		ISM-ZS30-ADAPTER
Digital camera for 5106-M50T		ISM-CM20, ISM-CM63
Camera adapter 0.5X for 5106-M50T**		ISM-MAS-ADAPTER

* 0.5X auxiliary objective must be used with ISM-ZS30-ADAPTER

** Digital camera must be used with camera adapter 0.5X

ZOOM STEREO MICROSCOPE (BASIC TYPE) CODE ISM-ZS30

SPECIFICATION

Optical tube	binocular
Eyepiece (wide field)	10X (view field: Ø20mm)
Objective	1X~4.5X (zoom)
Zoom ratio	1:4.5
Pupil distance	55~75mm (adjustable)
Diopter adjustment	±5 diopter (two eyepieces)
Working distance of objective	97mm
Max. workpiece height	60mm
Illumination	adjustable reflected and transmitted LED light
Power supply	110/220V, 50/60Hz
Dimension (L×W×H)	260×190×400mm
Weight	4.3kg



VIDEO



STANDARD DELIVERY

Main unit	1 pc
WF 10X eyepiece	2 pcs
Ø95mm glass plate	1 pc
Ø95mm white/black plate	1 pc
Anti-dust cover	1 pc



LED ring light (optional)

OPTIONAL ACCESSORY

Auxiliary objective	0.5X	ISM-ZS30-OB05X *
	0.63X	ISM-ZS30-OB06X *
	0.75X	ISM-ZS30-OB07X *
	2X	ISM-ZS30-OB2X
Eyepiece	10X dividing eyepiece (graduation 0.1mm/div.)	ISM-ZS30-EPD10X
	WF15X (view field: Ø16mm)	ISM-ZS50-EP15X
	WF20X (view field: Ø12mm)	ISM-ZS50-EP20X
LED ring light		ISM-ZS-RL
Sleeve for auxiliary objective		ISM-ZS30-ADAPTER
Digital camera		ISM-CM63
Camera adapter 0.75X **		ISM-AD-0D75

* 0.5X, 0.63X and 0.75X auxiliary objectives must be used with ISM-ZS30-ADAPTER

** Digital camera must be used with camera adapter 0.75X

DIGITAL CAMERA FOR MICROSCOPES (WITH PAD) CODE ISM-ZS70-S

- Windows 10 operation system
- Built-in software, can take pictures and videos, can measure
Language: Chinese, English, French, Japanese, German, Polish, Arabic
- Automatic exposure, white balance, brightness, contrast ratio, saturation are adjustable
- Image process feature: zoom in/out, flip, mirror, stitching and so on
- Output to Excel or CSV file



VIDEO

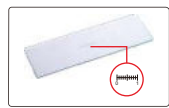

glass calibration rule (included, graduation 0.1mm)

SPECIFICATION

Sensor	1/2.3" CMOS
Pixel	16M
Resolution	800×600, 1600×1200, 1920×1080, 2048×1536, 2304×1728, 2592×1944, 4608×3456
Frame rate	30fps (1920×1080)
Output	HDMI, USB 3.0
Power supply	power adapter
Dimension (L×W×H)	280.3×177.4×12.5mm
Weight	0.9kg

STANDARD DELIVERY

Main unit	1 pc
Mouse	1 pc
Glass calibration rule (graduation 0.1mm)	1 pc
AC/DC adapter	1 pc

Measurement tools



measure line



measure meanderline



arrow mark



measure polygon



calibration



measure angle



measure rectangle



measure circle



text mark



show/hide scale

MEASUREMENT, TAKE PICTURES AND VIDEOS

ATTENTION: CAMERA CONNECTOR AND ADAPTER ARE NEEDED ACCORDING TO MICROSCOPES

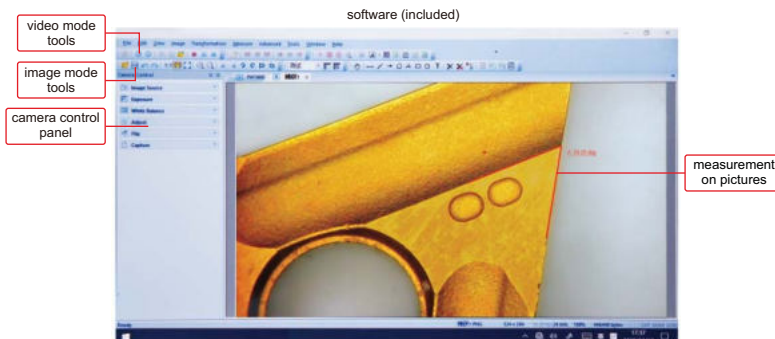
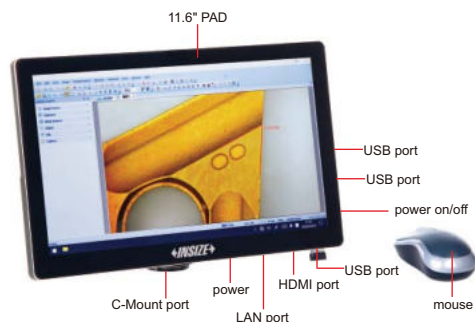

DIGITAL CAMERA FOR MICROSCOPES CODE ISM-CM63

**ATTENTION: ADAPTERS ARE NEEDED
ACCORDING TO MICROSCOPES**



C-mount port

adapter 0.75X (optional)



application



- To be used with computers
- Sony Exmor back-illuminated CMOS sensor
- USB3.0 transmission
- Automatic exposure, gain adjustment, white balance, chrominance adjustment, saturation adjustment, gamma correction, luminance adjustment, contrast adjustment

software (included)

selectable resolution

histogram
(quantify the distribution of color and brightness)

measurement items

real time gray calibration

black balance
(reduce color difference)

flat field correction
(reduce brightness difference)

dark field correction
(reduce thermal noise)

The software can control image completely, including measurement, image stitch, extend focus depth, image gray processing, RGB histogram observation, image color sampling, 3D plot(3D representation of image intensity), image exposure, white balance, black balance, image bit depth, flat field correction and dark field correction, etc.

Measurement tools:

- measure length of line or distance between two points
- measure rectangle
- measure angle
- measure radius, girth and area of circle
- measure axis lengths, girth and area of ellipse
- calibration
- measure distance between two parallel lines
- measure width and diameter of ring
- measure diameter, length, perimeter angle of arc
- measure area of polygon
- measure center distance between two circles
- measure length of open curve

counting

select counting tool

automatic counting

SPECIFICATION

Sensor (back-up)	1/1.8" CMOS
Resolution	3072×2048
Pixel	6.3M
Single pixel size	2.4×2.4µm
Spectral range	380-650nm (with infrared cut filter)
Frame rate	30fps
Sampling average	1×1
Exposure time	0.1ms~15s
Power supply	USB port
Weight	400g

STANDAER DELIVERY

Camera (USB cable included)	1 pc
Software	1 pc

COMPUTER REQUIREMENT

Operation system	Windows/7/8/10
CPU	Intel Core 2 2.8Hz or above
Memery	2GB or above
USB port	USB3.0 (Recommad) or USB2.0
Display	17" or above

OPTIONAL ACCESSORY

Adapter 0.75X	ISM-AD-0D75
---------------	-------------

Extend focus depth

focus on the top

focus on the bottom

clear image of both top and bottom

automatic image stitching (expand field of view)

left side

right side

after stitching

Binary

separate target and background

3D plot

Visualize the distribution of image brightness and color

PORTABLE MEASURING MICROSCOPE

SPECIFICATION

Code	ISM-PM100
Total magnification	100X
Eyepiece	10X with graduation
Objective (achromatic)	10X (numerical aperture: 0.25)
Working distance	7mm
Graduation	0.01mm
Viewing field	Ø1.8mm
Focus range	30mm
Illumination	LED light
Diameter of base	Ø63mm
Height	210mm
Weight	650g

STANDARD DELIVERY

Main unit	1 pc
Pen light	1 pc
Battery (AAA)	2 pcs

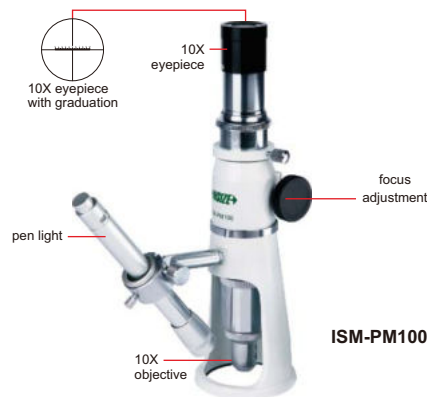

ISM-PM100

DIGITAL MAGNIFIER CODE 7525-D4

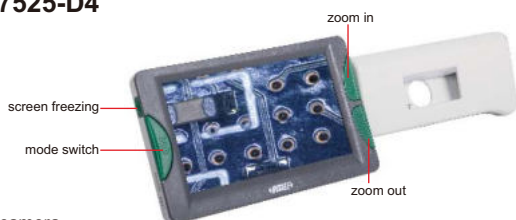

- 720P60 camera
- Auto focus
- With screen freezing function
- 26 color modes can be switched to meet the needs of different people
- Port to TV
- Automatic shutdown after 3 minutes

STANDARD DELIVERY

Main unit	1 pc
Video output cable	1 pc
USB charging cable	1 pc
Power adapter	1 pc

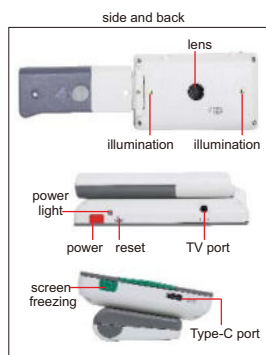

SPECIFICATION

Screen size	4.3 inch
Screen resolution	480x272
Magnification	2X-32X
Pixel	8M
Focus	manual/automatic
Color mode (26 modes)	color mode, color enhancement mode, negative mode, monochrome mode, black on white, white on black, blue on white, white on blue, yellow on black, black on yellow, yellow on blue, blue on yellow, green on white, white on green, orange on white, white on orange, red on black, black on red, orange on black, black on orange, yellow on green, green on yellow, red on white, white on red, yellow on white, white on yellow
Output	TV
Charging port	Type-C
Lithium battery	1600mAH (for 4 hours working)
Dimension (LxWxH)	123x39x76mm (when the handle is folded)
Weight	210g

DIGITAL MAGNIFIER CODE 7526-D5

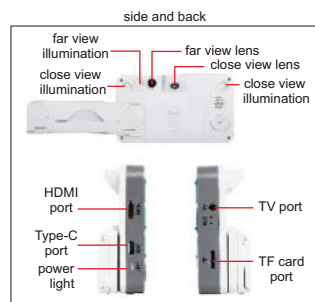
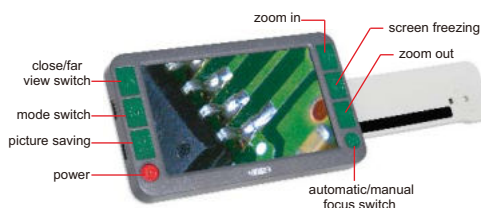

- 720P60 (close view) and 1080P30 (far view) cameras
- Double autofocus
- 26 color modes can be switched to meet the needs of different people
- Adopt folding bracket
- Detachable handle design, suitable for left-handed or right-handed use
- TV and HDMI ports to TV and display
- Automatic shutdown after 3 minutes

STANDARD DELIVERY

Main unit	1 pc
HDMI cable	1 pc
Video output cable	1 pc
USB charging cable	1 pc
Power adapter	1 pc

SPECIFICATION

Screen size	5 inch
Screen resolution	800x480
Magnification	2X-32X
Close view pixel	8M
Far view pixel	8M
Focus	manual/automatic
Color mode (26 modes)	color mode, color enhancement mode, negative mode, monochrome mode, black on white, white on black, blue on white, white on blue, yellow on black, black on yellow, yellow on blue, blue on yellow, green on white, white on green, orange on white, white on orange, red on black, black on red, orange on black, black on orange, yellow on green, green on yellow, red on white, white on red, yellow on white, white on yellow
Line	horizontal and vertical red lines
Function	screen freezing, image moving, photo playback, and high definition storage
Output	TV and HDMI
storage	supports up to 32G TF card
Charging port	Type-C
Lithium battery	2500mAH (for 4 hours working)
Dimension (LxWxH)	145x30x85mm (when the handle is folded)
Weight	275g

TABLE MAGNIFIER WITH ILLUMINATION CODE 7517-3D



- Four steps brightness adjustment
- LED illumination, working life 20000h
- Resin lens

SPECIFICATION

Magnification	1.75X
Diopter	3D
Lens diameter	Ø125mm
Illumination	power: 3W, illuminance: 260lm
Power supply	power adapter 12V, 1A

TABLE MAGNIFIER WITH ILLUMINATION CODE 7516-5D



- LED illumination, working life 20000h

SPECIFICATION

Magnification	2.25X
Diopter	5D
Lens diameter	Ø122mm
Illumination	power: 7W, illuminance: 420lm
Power supply	100~240V, 50~60Hz



TABLE MAGNIFIERS WITH ILLUMINATION

- LED illumination, working life 20000h
- Resin lens

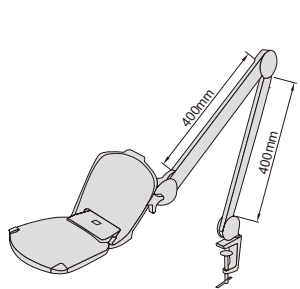

7520-320D



7521-3D

SPECIFICATION

Code	7520-320D	7521-3D
Magnification	two magnifications 1.75X/6X	1.75X
Diopter	3D/20D	3D
Lens diameter	160×127mm	Ø126mm
Illumination	power: 6W, illumination: 550lm	
Power supply	power adapter 12V, 1A	

FOLDING MAGNIFIER



7511-8

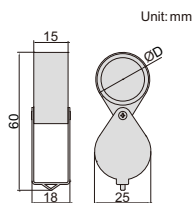

- Glass lens

Code	Magnification	Lens diameter (ØD)
7511-8	10X	Ø21mm



FOLDING MAGNIFIER WITH ILLUMINATION



7515-10

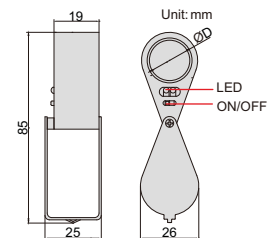

- Resin lens
- Powered by 3xLR927 batteries (included)

Code	Magnification	Lens diameter (ØD)
7515-10	10X	Ø21mm



FOLDING MAGNIFIER WITH ILLUMINATION



- Resin lens
- Powered by 2xCR1620 batteries (included)
- LED lights up automatically when opened

Code	Magnification	Lens diameter (ØD)
7514-1	2.5X	Ø45mm



MAGNIFIER WITH ILLUMINATION



- Glass lens
- Powered by 3xAG7 batteries
- 3 pcs LED and 3 pcs UV
- Base with scale, graduation: 0.5mm, 1/16"

Code	Magnification	Lens diameter (ØD)	L	H	W
7524-10	10X	Ø30mm	60mm	50mm	56mm

MAGNIFIERS WITH ILLUMINATION



- Glass lens
- Powered by 3xAAA batteries (included)

Code	Magnification	Lens diameter (ØD)	L	h
7513-2	2X	Ø75mm	170mm	90mm
7513-4	4X	Ø50mm	145mm	90mm



MAGNIFIER WITH TWO LENSES



- Resin lens
- Interchangeable lenses
- Powered by 3 pcs AAA batteries (included)

Code	Lens number	Magnification	Lens diameter (ØD)
7522-610	2 pcs	6X	50mm
		10X	37mm



MAGNIFIER WITH ILLUMINATION

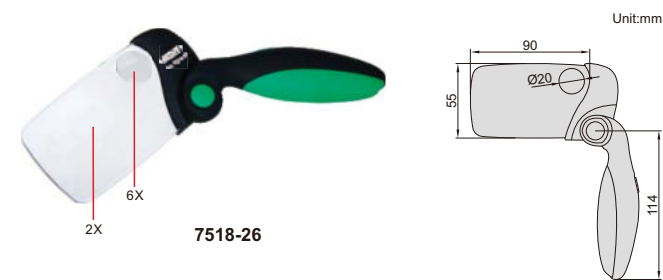

- Two magnifications
- LED illumination
- Powered by 2 pcs AAA batteries (included)
- Resin lens

Code	Magnification	Lens size
7518-26	2X/6X	90x55mm



THREE WAYS MAGNIFIER WITH ILLUMINATION

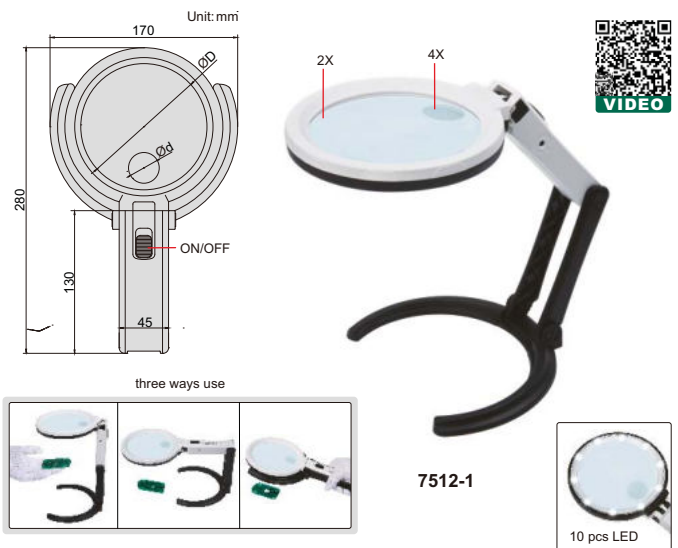

- Resin lens
- Powered by 2xAA batteries (included) or power adapter (110~240V, 50~60Hz)

Code	Magnification	Lens diameter (ØD/Ød)
7512-1	2X/4X	Ø120mm/Ø28mm

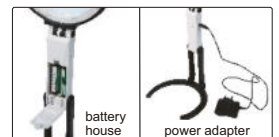

MAGNIFICATION GLASSES



- Resin lens
- Interchangeable lenses
- Powered by 3 pcs AAA batteries (included)



7523-3D5

head band (included)



Code	Lens number	Magnification
7523-3D5	5 pcs	1X
		1.5X
		2X
		2.5X
		3.5X

adjustable holder angle



moveable lens for focus



adjustable lens and LED angle

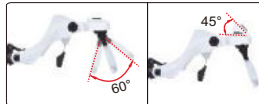

2 pcs LED



interchangeable lenses



TELESCOPING INSPECTION MIRRORS

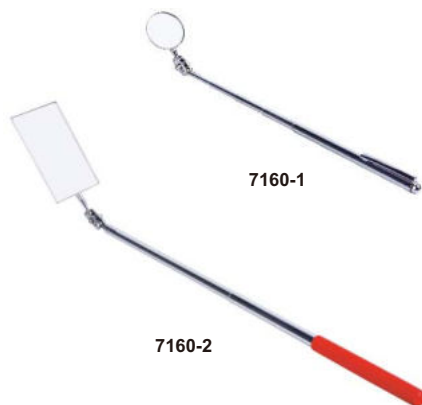

7160-1

7160-2

- Inspect hidden areas
- Rotation of the mirror: 360°
- Length of the handle is adjustable, the handle is made of stainless steel

Code	Size of mirror	Length
7160-1	Ø32mm	178~515mm
7160-2	50x90mm	330~490mm

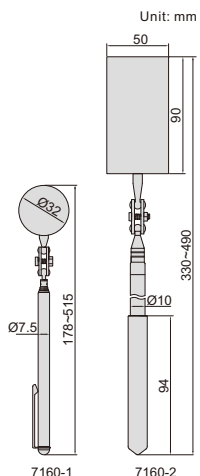

TELESCOPING INSPECTION MIRROR (WITH ILLUMINATION)



7162-1

- Inspect hidden areas
- Head can bend and rotate
- Telescoping handle, made of stainless steel
- With two CR2032 batteries

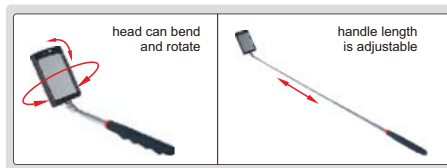

Code	Size of mirror	Length
7162-1	65x42mm	285~875mm

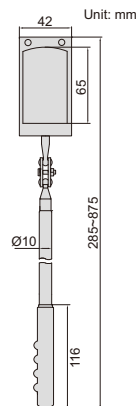

TELESCOPING MAGNETIC PICK-UP AND FLASHLIGHT



magnetic head



magnetic end to attach on steel surfaces



7163-1

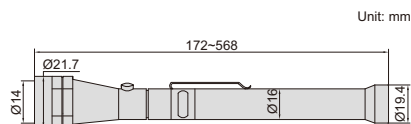

- For illumination and pick up metal parts in hidden areas
- Head can bend
- Telescoping handle, made of stainless steel
- Magnetic head and end
- With four LR44 batteries



Code	Magnetic end	Magnetic head	Flashlight range	Battery life	Length (mm)
7163-1	4kgf	2kgf	3m	8h	172~568

TELESCOPING MAGNETIC PICK-UP



7161-1

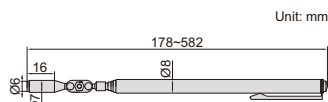

- Pick up metal parts from hidden areas
- Rotation of the magnetic head: 360°
- Length of the handle is adjustable, the handle is made of stainless steel

Code	Size of magnetic tip	Magnetic force	Length
7161-1	Ø6mm	0.45kgf	178~582mm

FLEXIBLE PICK-UP AND FLASHLIGHT

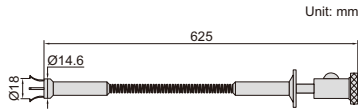

Unit: mm

- For illumination and pick up steel parts in hidden areas
- Flexible spring rod, made of stainless steel
- Three LR44 batteries

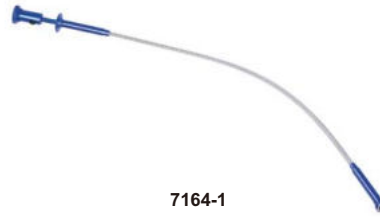

7164-1



flexible spring rod



flashlight head



magnetic head



4 retractable claws

Code	Magnetic force	Flashlight range	Battery life
7164-1	0.9kgf	1m	24h

VIDEOSCOPIES

REAR FIBER ILLUMINATION



VIDEO

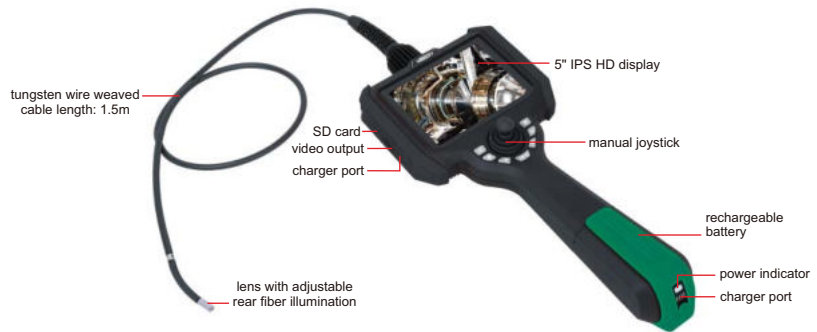

ISV-K6015

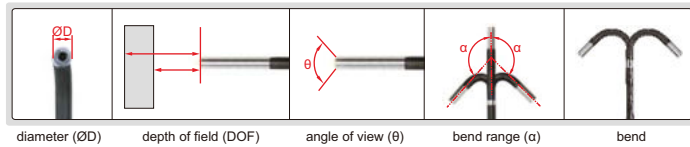

diameter (ØD) depth of field (DOF) angle of view (θ) bend range (α) bend



changeable lens cable

SPECIFICATION

Code	ISV-K3915	ISV-K6015	
Lens	diameter (ØD)	3.9mm	6.0mm
	pixel	0.92M	
	resolution	1280×720	
	depth of field	8-150mm	12-200mm
	bending direction	four directions	four directions
	bending range (α)	±160°	
	angle of view (θ)	120°	
	illumination	rear fiber	
	lens	sapphire glass lens	
	dust/waterproof	IP67	
Cable	bend control	manual joystick	
	length	1.5m	1.5m
Main unit	type	tungsten wire weaved cable	
	display	5" high definition LCD	
	function	take pictures, take videos	
	file format	picture: JPG, video: MP4	
	image process	image zoom (1X, 2X, 3X, 4X)	
	image control	freeze, flip over, playback and analog ruler	
	memory	memory card	
	output	USB, HDMI	
power supply	rechargeable lithium battery (working time ≥ 4hours), AC/DC adapter (for continuous working)		
Weight	1000g		

STANDARD DELIVERY

Main unit	1 pc
32G SD card	1 pc
Card reader	1 pc
USB cable	1 pc
Tripod	1 pc
AC/DC adapter	1 pc

OPERATION ENVIRONMENT

Main unit	-10~50°C, no preheat
Operation temperature	-20~70°C
Storage temperature	-20~60°C
Relative humidity	maximum 90%, no condensation

OPTIONAL ACCESSORY

WiFi output	ISV-K-WIFI (must be installed in factory, only for Android OS)
Temperature alarm	ISV-K-HTALARM (must be installed in factory)
Clamp	ISV-K-CLAMP1, ISV-K-CLAMP2, ISV-K-CLAMP3, ISV-K-CLAMP4 (must be installed in factory)

MOBILE PHONE VIDEOSCOPE



■ For Android and IOS mobile phones

SPECIFICATION

Code	ISV-P6
Diameter of lens (ØD)	6±0.2mm
Length of cable	1m
Resolution	960×720, 1280×720 (switchable)
Depth of field	20mm~∞
Angle of view (θ)	100°
Bending range (α)	0~180°
Illumination	LED with 3 levels control
Cable type	wear resistant
Interface	USB, type-C
Mobile phone system	Android, IOS
Power supply	rechargeable battery (for 2 hours working)
Dimension (L×W×H)	195×57×105mm
Weight	450g

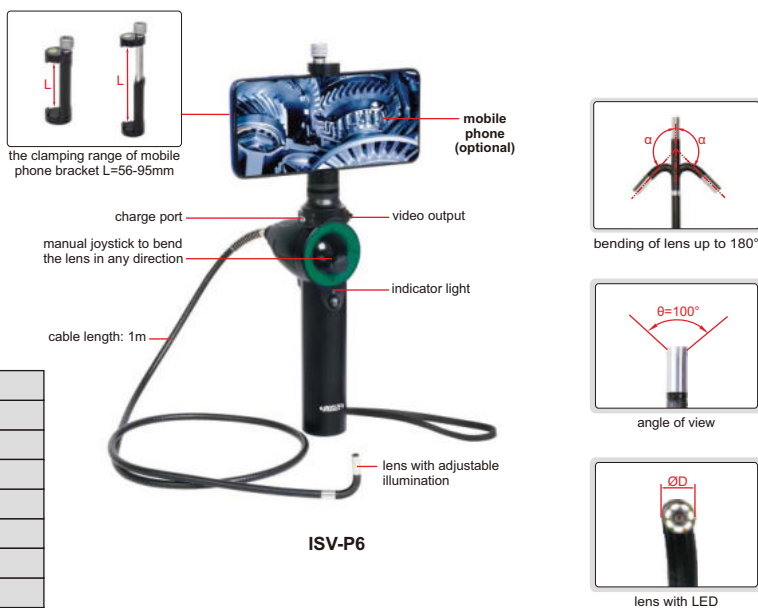

ISV-P6

STANDARD DELIVERY

Main unit (with cable)	1 pc
Type-C cable	1 pc
Micro USB cable	1 pc
Iphone cable	1 pc
Charging cable	1 pc



VIDEOSCOPE (BASIC TYPE)

TUNGSTEN WIRE WEAVED CABLE
BREAK AND WEAR RESISTANCE



SPECIFICATION

Code	ISV-S106	
Lens	diameter (ØD)	6mm
	pixel	1M
	resolution	1280×720
	depth of field	20~150mm
	bending direction	360°
	bending range (α)	0°~220°
	angle of view (θ)	120°
	illumination	7 pcs LED, with 6 levels control
	illuminance	25000Lux
	lens	sapphire glass lens
	dust/waterproof	IP67
	bend control	manual joystick
	temperature alarm	temperature sensor (optional)
Cable	length	1.5m
	type	tungsten wire weaved cable
Main unit	display	3.5" IPS full-view display
	display resolution	640×480
	function	take pictures, take videos
	file format	picture: JPG, video: MP4
	image process	image zoom (1X, 2X, 3X, 4X, 5X)
	memory	memory card (maximum: 64G)
	output	USB, HDMI, WIFI (optional)
	dust/waterproof	IP65
power supply	rechargeable lithium battery (working time ≥ 3 hours; optional: additional battery, working time ≥ 9 hours) AC/DC adapter (for continuous working)	
Weight	1000g	



ISV-S106

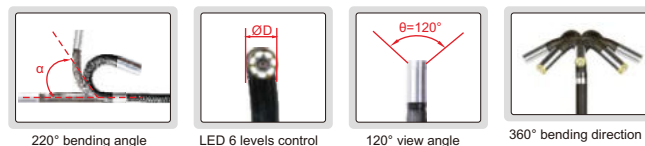

STANDARD DELIVERY

Main unit (with cable & lens)	1 pc
16G SD card	1 pc
Card reader	1 pc
USB cable	1 pc
Battery	1 pc
AC/DC adapter	1 pc

OPTIONAL ACCESSORY

Additional battery	ISV-S106-BATTERY (must be installed in factory)
WIFI output	ISV-S106-WIFI
Temperature alarm	ISV-S106-HT-ALARM

VIDEOSCOPE (BASIC TYPE) CODE ISV-E40



MEMORY CABLE CAN BE
FIXED AT ANY SHAPE

IP67
WATERPROOF

lens with 8 pcs LED
adjustable illumination



hook (included)



magnet pick up (included)



45° mirror (included)



memory cable

SPECIFICATION

Lens	diameter (ØD)	8mm
	pixel	0.92M
	resolution	1280x720
	depth of field	30~80mm
	angle of view	77°
	illumination	3 levels
	dust/waterproof	IP67
Cable	length	1180mm
	type	memory (can be set at any shape)
Main unit	display	5" IPS LCD
	function	take picture, take video
	file format	picture: JPG, video: MOV
	image process	image zoom (1.5X, 2X, 3X, 4X)
	memory	memory card (optional)
	output	type-C
	power supply	rechargeable lithium battery (for 5 hours working)
dimension	217×155×131mm	
Weight		506g

STANDARD DELIVERY

Main unit	1 pc
45° mirror	1 pc
Hook	1 pc
Magnet pick up	1 pc

OPTIONAL ACCESSORY

32G memory card	ISV-E40-CARD
Card reader	ISV-E40-READER

OPERATION ENVIRONMENT

Operation temperature	-10~50°C
Storage temperature	-20~60°C
Operation humidity	15%~85%

VIDEOSCOPE (ECONOMIC TYPE) CODE ISV-E30

IP67
WATERPROOF

MEMORY CABLE CAN BE
FIXED AT ANY SHAPE



SPECIFICATION

Lens	diameter	5.2mm
	pixel	0.4M
	depth of field	30~80mm
	angle of view	72°
	illumination	8 levels
	dust/waterproof	IP67
Cable	length	1m
	type	memory (can be set at any shape)
Main unit	display	4.3" LCD
	function	take picture, take video
	file format	picture: JPG, video: AVI
	image zoom	2X
	memory card	memory card (optional)
	output	micro USB
	power supply	AA battery
dimension	154×32.5×87.5mm	
Weight		280g

lens
(adjustable illumination)



memory cable
length: 1m



cable can be wrapped around the main unit



hook (included)



magnet pick up (included)

STANDARD DELIVERY

Main unit	1 pc
Hook	1 pc
Magnet pick up	1 pc
AA battery	4 pcs

OPTIONAL ACCESSORY

32G memory card	ISV-E40-CARD
Card reader	ISV-E40-READER

OPERATION ENVIRONMENT

Operation temperature	-10~50°C
Storage temperature	-20~60°C
Operation humidity	15%~85%

COATING THICKNESS GAGE (HIGH PRECISION) CODE ISO-8000FN

SUITABLE FOR THIN
COATING BELOW 10µm

FOR MAGNETIC AND
NON-MAGNETIC SUBSTRATES



calibration foils
(included)



zero calibration plate
(included)



eddy current probe
(optional)



magnetic induction
probe (included)

- Can measure thickness of thin coating below 10µm
- High repeatability
- Magnetic induction probe measures the thickness of non-magnetic coating and non-metallic coating on magnetic metal substrate
Substrate: iron, steel, magnetic stainless steel (not for non-magnetic stainless steel)
Coating: zinc, aluminum, copper, chrome, tin, plastic, powder, paint (not for nickel)
- Eddy current probe measures the thickness of non-conductive coating on non-magnetic metal substrate
Substrate: copper, aluminum, zinc, non-magnetic stainless steel
Coating: plastic, powder, paint, anodizing (not for chrome and zinc plating)
- Maximum, minimum, average and variance values can be calculated automatically

SPECIFICATION

Probe	magnetic induction probe (included)		eddy current probe (optional)*	
Measuring range	0~500µm		0~1500µm	
Resolution	0.1µm (range<100µm) 1µm (100µm≤range≤500µm)		0.1µm (range<100µm) 1µm (100µm≤range<1000µm) 0.01mm (1.00mm≤range≤1.50mm)	
Accuracy	±(0.5+2%L)µm L is measuring thickness in µm			
Repeatability	≤(0.2+0.8%L)µm L is measuring thickness in µm			
Measuring mode	single and continuous			
Measure interval	single mode	1.5s	0.8s	
	continuous mode	0.4s	0.4s	
Calibration mode	zero calibration and multi-points calibration (1~5 points)			
Minimum substrate thickness	0.1mm		0.05mm	
Minimum measuring area	Ø7mm			
Minimum radius of curvature workpieces	convex surface	1.5mm		
	concave surface	10mm		
Unit	µm/mil			
Power supply	4×1.5V AAA batteries			
Dimension	148×76×26mm			
Weight	148g			



stand (optional)

*For precision measurement of thin coating below 10µm, please use the stand for eddy current probe

STANDARD DELIVERY

Main unit	1 pc
Magnetic induction probe	1 pc
Zero calibration plate	1 pc
Calibration foils (5.6µm, 11.6µm, 24.6µm, 50.0µm, 100µm, 252µm, 390µm)	1 set
1.5V AAA battery	4 pcs

OPTIONAL ACCESSORY

Eddy current probe (with zero calibration plate)	ISO-8000FN-N1500*
Stand	ISO-8000FN-STAND

COATING THICKNESS GAGE (BASIC TYPE) CODE ISO-1200FN



FOR MAGNETIC AND
NON-MAGNETIC SUBSTRATES

- Probe is suitable for both magnetic and non-magnetic metal substrates
- Can measure the thickness of non-magnetic coating and non-metallic coating on magnetic metal substrate
Substrate: iron, steel, magnetic stainless steel (not for non-magnetic stainless steel)
Coating: zinc, aluminum, copper, chrome, tin, plastic, powder, paint (not for nickel)
- Can measure the thickness of non-conductive coating on non-magnetic metal substrate
Substrate: copper, aluminum, zinc, non-magnetic stainless steel
Coating: plastic, powder, paint, anodizing (not for chrome and zinc plating)
- 3 measuring modes: Fe, NFe, Fe/NFe
- Store 9 measuring records
- Small and portable, easy for operation



SPECIFICATION

Measuring range	0~2000µm	
Resolution	0.1µm (range<100µm) 1µm (100µm≤range<1000µm) 0.01mm (1mm≤range≤2mm)	
Accuracy	±(2µm+3%L) L is measuring thickness in µm	
Measure interval	0.5s	
Calibration mode	zero calibration	
Measuring mode	Fe, NFe, Fe/NFe	
Minimum substrate thickness	Fe	0.2mm
	NFe	0.05mm
Minimum measuring area	Ø25mm	
Minimum radius of curvature workpieces	convex surface	5mm
	concave surface	25mm
Unit	µm/mil	
Power supply	2×1.5V AA batteries	
Main unit dimension	101×62×28mm	
Probe dimension	71×26×22mm	
Weight	114g	

STANDARD DELIVERY

Main unit	1 pc
Fe zero calibration plate	1 pc
NFe zero calibration plate	1 pc
Standard foil (100µm)	1 pc
1.5V AA battery	2 pcs

COATING THICKNESS GAGE (BASIC TYPE) CODE ISO-1000FN



FOR MAGNETIC AND
NON-MAGNETIC SUBSTRATES

- Probe is suitable for both magnetic and non-magnetic metal substrates
- Can measure the thickness of non-magnetic coating and non-metallic coating on magnetic metal substrate
Substrate: iron, steel, magnetic stainless steel (not for non-magnetic stainless steel)
Coating: zinc, aluminum, copper, chrome, tin, plastic, powder, paint (not for nickel)
- Can measure the thickness of non-conductive coating on non-magnetic metal substrate
Substrate: copper, aluminum, zinc, non-magnetic stainless steel
Coating: plastic, powder, paint, anodizing (not for chrome and zinc plating)
- 3 measuring modes: Fe, NFe, Fe/NFe
- Store 9 measuring records
- Small and portable, easy for operation



SPECIFICATION

Measuring range	0~2000µm	
Resolution	0.1µm (range<100µm) 1µm (100µm≤range<1000µm) 0.01mm (1mm≤range≤2mm)	
Accuracy	±(2µm+3%L) L is measuring thickness in µm	
Measure interval	0.5s	
Calibration mode	zero calibration	
Measuring mode	Fe, NFe, Fe/NFe	
Minimum substrate thickness	Fe	0.2mm
	NFe	0.05mm
Minimum measuring area	Ø25mm	
Minimum radius of curvature workpieces	convex surface	5mm
	concave surface	25mm
Unit	µm/mil	
Power supply	2×1.5V AA batteries	
Dimension	101×62×28mm	
Weight	79g	

STANDARD DELIVERY

Main unit	1 pc
Fe zero calibration plate	1 pc
NFe zero calibration plate	1 pc
Standard foil (100µm)	1 pc
1.5V AA battery	2 pcs

COATING THICKNESS GAGE CODE 9501-1200

FOR MAGNETIC AND
NON-MAGNETIC SUBSTRATES

DATA
OUTPUT



software CD
(included)



VIDEO

- Magnetic induction probe (FE) measures the thickness of non-magnetic coating and non-metallic coating on magnetic metal substrate.
Substrate: iron, steel, magnetic stainless steel (not for non-magnetic stainless steel)
Coating: zinc, copper, chrome, tin, plastic, powder, paint (not for nickel)
- Eddy current probe (NFE) measures the thickness of non-conductive coating on non-magnetic metal substrate.
Substrate: copper, aluminum, zinc, non-magnetic stainless steel
Coating: plastic, powder, paint, anodizing (not for chrome and zinc plating)
- Tolerance measurement
- Automatic power off



eddy current probe
NFE (optional) with
zero calibration block



magnetic induction
probe FE90 for bores
and grooves (optional)



magnetic induction
probe FE10 for large
range (optional)



zero calibration block
for FE (included)



calibration foils
(included)



data transmission
cable (optional)

SPECIFICATION

Probe type	FE (included) magnetic induction probe	NFE (optional) eddy current probe	FE90 (optional) magnetic induction probe for bores and grooves	FE10 (optional) magnetic induction probe for large range
Measuring range	0~1250µm	0~1250µm	0~1250µm	500~10000µm
Accuracy	$\pm(3\%L+1)\mu\text{m}$ (range $\leq 1250\mu\text{m}$) $\pm(3\%L+10)\mu\text{m}$ (range $> 1250\mu\text{m}$) L is measuring thickness in µm			
Resolution	0.1µm (range $< 100\mu\text{m}$) 1µm (range $\geq 100\mu\text{m}$)			
Measuring mode	continuous and single			
Minimum substrate thickness	0.5mm	0.3mm	0.5mm	2mm
Minimum measuring area	Ø7mm	Ø5mm	Ø7mm	Ø40mm
Minimum curvature radius of convex workpiece	1.5mm	3mm	-	10mm
Memory	500			
Output	USB			
Power supply	2×1.5V AA batteries			
Dimension	128×68×32mm			
Weight	340g			

STANDARD DELIVERY

Main unit	1 pc
Magnetic induction probe (FE)	1 pc
Zero calibration block for FE probe	1 pc
Calibration foils (50µm, 100µm, 250µm, 500µm, 1000µm)	1 set
1.5V AA battery	2 pcs
Software and USB cable	1 pc

OPTIONAL ACCESSORY

Data transmission cable	9501-1200-SPC
Eddy current probe (NFE) with zero calibration block	9501-1200-NFE
Magnetic induction probe (FE90) for bores and grooves	9501-1200-FE90
Magnetic induction probe (FE10) for large range	9501-1200-FE10

SURFACE PROFILE GAGE

- Measure peak-to-valley height of blast cleaned surface.
If the profile is too low, the adhesion of the coating to the surface will be reduced.
If the profile is too high, there is the danger that the profile peaks will remain uncoated, allowing rust spots to occur.
- Meet ASTM D 4417-B
- Zero set block is included, set zero before measurement
- Stainless steel base



2344-1

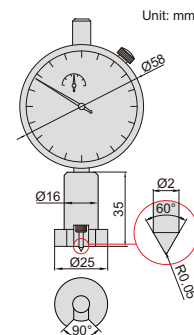

measure peak-to-valley height
of blast cleaned surface

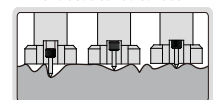

Code	Range	Dial indicator stroke	Dial indicator graduation	Accuracy
2344-1	0-1mm	1mm	0.001mm	±0.005mm



VIDEO

WET FILM GAGES

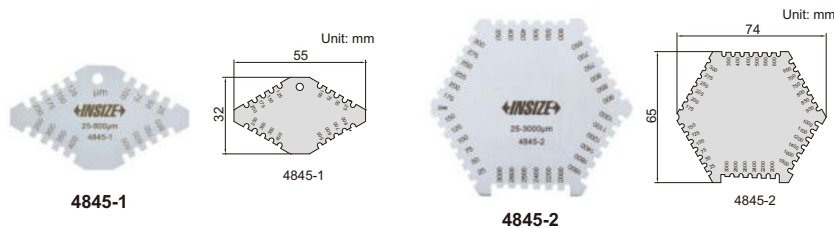

■ Made of stainless steel

Code	Range	Accuracy	Thickness
4845-1	25-800µm	±5µm	1.8mm
4845-2	25-3000µm	25-100µm: ±5µm 100µm-3000µm: ±5%	1mm

ULTRASONIC THICKNESS GAGE CODE ISU-720D

DATA
OUTPUT

WITH A AND
B SCAN

PENETRATE NON-METALLIC COATING AND
MEASURE THE THICKNESS OF METAL SUBSTRATES

- Two measuring modes, Echo-Echo (E-E) and Transmit-Echo (T-E):
 - E-E is applicable for non-metallic coating (such as paint, plastic resin, etc.) on metal substrates, can penetrate coating and measure the thickness of substrates
 - T-E is to measure the thickness of material without coating, such as metal, plastic, glass, nylon, resin, ceramics, ice, etc.
- A scan, through the waveform, judges whether there are impurities, pores, cracks and so on inside, in order to avoid wrong measurement
- B scan, measures continuously, displays the thickness change on the screen
- Transducers can be automatically identified and zeroed
- Memory 10000 measurement values
- Data can be input to Excel and Word as keyboard signal
- Automatic or manual measurement
- When transducers are removed from workpieces, the measurement data are held on screen for easy viewing
- Set upper and lower limits for alarm when out-of-tolerance
- Automatic power off

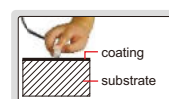

Echo-Echo mode (E-E)



couplant (included)

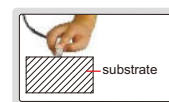

Transmit-Echo mode (T-E)



SPECIFICATION (ON STEEL)

Measuring range	T-E mode: substrate thickness 1.5~200mm E-E mode: substrate thickness 3~25mm
Measuring unit	mm/inch
Resolution	0.1/0.01mm
Accuracy	±0.04mm (H<9.9mm) ±(0.04+0.1%H) mm (H: 10~99.9mm) ±(0.3%H) mm (H>100mm) H is the thickness to be measured in mm
Frequency	5.0MHZ
Display	320×240, color screen display
Velocity	1000~9999m/s
Measuring frequency	2 times/second and 10 times/second
Applicable temperature	-20~50°C
Output	USB
Power supply	2×1.5V AA batteries
Dimension	133×75×29mm
Weight	260g (including batteries)

STANDARD DELIVERY

Main unit	1 pc
Bicrystal transducer ISU-T07	1 pc
Battery (AA)	2 pcs
Couplant	1 bottle
USB cable	1 pc

OPTIONAL ACCESSORY

Transducer	ISU-T04, ISU-T06, ISU-T08, ISU-T12, ISU-T13, ISU-T25
Couplant (for ISU-T13)	ISU-HT5-COULPLANT

transducer ISU-T04 (optional)



transducer ISU-T06 (optional)



transducer ISU-T08 (optional)



transducer ISU-T12 (optional)



transducer ISU-T13 (optional)



transducer ISU-T25 (optional)

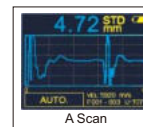

A Scan

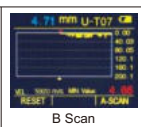

B Scan

SPECIFICATION OF TRANSDUCERS (ON STEEL)

Code	Mode	Frequency	Diameter (Ød)	Measuring range	Minimum size of pipes for measurement (diameter × wall thickness)	Applicable temperature	Application
ISU-T07 (included)	T-E E-E	5.0MHz	13.2mm	T-E mode: 1.5~200mm E-E mode: 3~25mm	T-E mode: Ø25×3mm	<60°C	general use
ISU-T04 (optional)	T-E	10.0MHz	6mm	0.7~20mm	Ø15×1mm	<60°C	for small tubes
ISU-T06 (optional)	T-E	7.5MHz	9mm	0.7~50mm	Ø15×1.2mm	<60°C	for thin workpieces
ISU-T08 (optional)	T-E	5.0MHz	11mm	0.8~300mm	Ø25×1.2mm	<60°C	general use
ISU-T12 (optional)	T-E	2.0MHz	17mm	2~400mm	Ø40×3mm	<60°C	for casting iron
ISU-T13 (optional)	T-E	5.0MHz	15mm	3~100mm	Ø25×2mm	<350°C	for high temperature
ISU-T25 (optional)	T-E	1.0MHz	26mm	3~200mm	-	<60°C	for fiberglass and organic material

ULTRASONIC THICKNESS GAGE CODE ISU-250C



DATA
OUTPUT



- Measure the thickness from one side of objects, suitable for pipes, tanks, etc.
- Applicable material: metal, plastic, glass, nylon, resin, ceramic, ice
- Tolerance measurement
- Average calculation of maximum 9 readings
- Data can be input to Excel and Word as keyboard signal

SPECIFICATION (ON STEEL)

Resolution	0.01mm (range<100mm)
	0.1mm (range≥100mm)
Repeatability	0.03mm (range<100mm)
	0.1mm (range≥100mm)
Accuracy	±0.04mm (range<10mm)
	±(0.04+H/1000)mm (range 10~100mm)
	±H/333mm (range≥100mm)
	H is the thickness to be measured in mm
Velocity	1000-9999m/s
Power supply	2×1.5V AAA batteries
Dimension	64×116×27mm
Weight	220g

SPECIFICATION OF TRANSDUCERS (ON STEEL)

Code	Frequency	Diameter (Ød)	Measuring range	Minimum size of pipes for measurement (diameter × wall thickness)	Applicable temperature	Application
ISU-T08 (included)	5.0MHz	11mm	0.8~300mm	Ø25×1.2mm	<60°C	general use
ISU-T04 (optional)	10.0MHz	6mm	0.7~20mm	Ø15×1mm	<60°C	for small tubes
ISU-T06 (optional)	7.5MHz	9mm	0.7~50mm	Ø15×1.2mm	<60°C	for thin workpieces
ISU-T12 (optional)	2.0MHz	17mm	2~400mm	Ø40×3mm	<60°C	for casting iron
ISU-T13 (optional)	5.0MHz	15mm	3~100mm	Ø25×2mm	<350°C	for high temperature



couplant (included)



transducer ISU-T04 (optional)



transducer ISU-T06 (optional)

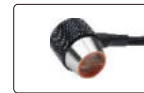

transducer ISU-T12 (optional)



transducer ISU-T13 (optional)

STANDARD DELIVERY

Main unit	1 pc
Transducer ISU-T08	1 pc
Battery (AAA)	2 pcs
Couplant (for ISU-T04, ISU-T06, ISU-T08, ISU-T12)	1 bottle
USB cable	1 pc

OPTIONAL ACCESSORY

Transducer	ISU-T04, ISU-T06, ISU-T12, ISU-T13
Couplant (for ISU-T13)	ISU-HT5-COUPPLANT

ULTRASONIC THICKNESS GAGE (BASIC TYPE) CODE ISU-100D

ATTENTION: NOT SUITABLE FOR
CASTINGS AND ALUMINUM WORKPIECES



- Measure the thickness from one side of objects, suitable for pipes, tanks, etc.
- Applicable material: steel, stainless steel, glass, copper, brass, polystyrene, titanium, etc.



STANDARD DELIVERY

Main unit	1 pc
Transducer	1 pc
Couplant	1 bottle
Battery (AAA)	2 pcs

SPECIFICATION (ON STEEL)

Measuring range	0.8~300mm	
Resolution	0.01mm (range<100mm)	
	0.1mm (range≥100mm)	
Accuracy	±0.04mm (range<10mm)	
	±(0.04+H/1000)mm (range 10~100mm)	
	±H/333mm (range≥100mm)	
	H is the thickness to be measured in mm	
Transducer	frequency	5MHz
	diameter (Ød)	10.8mm
Minimum size of pipes for measurement	20×1.2mm (diameter × wall thickness)	
Applicable temperature	<60°C	
Velocity	1000-9999m/s	
Power supply	2×AAA batteries	
Dimension	114×64×28mm	
Weight	200g	

LASER DISTANCE METERS



- Large display with backlight
- Unit: m, ft, in, ft+in
- Distance, area, volume and height measurement
- Continuous measuring mode to track maximum and minimum value
- Memory of 30 measurement values
- Automatic power off: laser 30s, main unit 180s



9561-50B

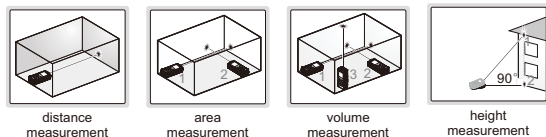

SPECIFICATION

Code	9561-50B	9561-70B
Measuring range	0.2~50m	0.2~70m
Resolution	0.001m, 0.001ft, 1/32"	
Accuracy	$\pm(2+D/11)$ mm D: measured distance, unit: m	
Laser type	630~670nm, class II, <1mW	
Power supply	2×AAA batteries	
Dimension (L×W×H)	115×50×28mm	
Weight	95g	

STANDARD DELIVERY

Main unit	1 pc
Battery (AAA)	2 pcs

INFRARED THERMOMETER (BASIC TYPE) CODE 0210-G260

- MAX/MIN temperature display
- °C/°F conversion function
- Auto data hold and auto power off



STANDARD DELIVERY

Main unit	1 pc
Battery	1 pc

SPECIFICATION

Measuring range	-30°C~260°C/-22°F~500°F
Accuracy	$\pm 4^{\circ}\text{C}/\pm 7^{\circ}\text{F}$ ($\leq 0^{\circ}\text{C}$) $\pm 2\%$ or $\pm 2^{\circ}\text{C}/\pm 4^{\circ}\text{F}$ ($> 0^{\circ}\text{C}$)
Resolution	0.1°C/0.1°F
Distance to spot size (D:S)	8:1
Emissivity	0.95 (fixed)
Diode laser	output<1mW, wavelength 630~670nm class 2 (II) laser product
Spectral response	6~14μm
Response time	less than 1s
Power supply	9V battery
Dimension	82×42×160mm
Weight	180g

INFRARED THERMAL IMAGING CAMERA CODE 9130-H360



IP54
WATERPROOF

DATA
OUTPUT



- 4 inch high-brightness touchscreen
- Four image presentations: IR, visible, PIP and MIF
- WIFI real-time sharing, one-click connection to mobile devices
- USB interface for data transmission and charging
- Built-in illumination
- Video can be recorded and stored

STANDARD DELIVERY

Main unit	1 pc
Power supply adapter	1 pc
USB cable	1 pc
HDMI cable	1 pc
Capacitive screen gloves	1 pc
TF card (16GB)	1 pc

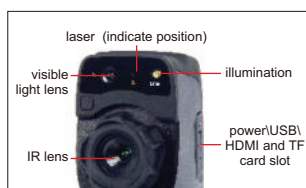

SPECIFICATION

IR resolution	192×144
NETD	≤50mk
Focus length	7mm/F1.1
Angle of view	37.8°×28.8°
Spatial resolution	3.45mrad
Focus adjustment	focus-free
Detector type	unrefrigerated vanadium oxide/8~14μm
Pixel size	25μm
Visible camera	resolution 500W, focus-free
Display	4" highlight LCD touch screen, 480×800
Image mode	IR image, visible image, MIF, PIP
Digital zoom	1.1~4
Color palette	8 modes
Temperature range	-20°C~350°C
Accuracy	$\pm 2^{\circ}\text{C}$ or $\pm 2\%$ (of maximize range)
Emissivity	0.01-1.00 (adjustable)
Storage	in camera and TF card (up to 32GB)
Image format	JPG with temp info
Output	USB, HDMI
Power	rechargeable Li-ion battery (7.4V), working time≥4h
Operation temperature	-10°C~50°C
Vibration	10HZ~150HZ~10HZ 0.15mm (IEC 60068-2-6)
Impact	30g 11ms (IEC 60068-2-27)
Weight	735g
Dimension	274×97×78mm

INFRARED THERMAL IMAGING CAMERA (BASIC TYPE) CODE 9132-T400

NON-CONTACT
TEMPERATURE MEASUREMENT



DATA
OUTPUT

IP54
WATERPROOF



front view



- IR/visible/laser indicator
- Trigger button for photo taking
- 2-meter drop test, IP54 protection

STANDARD DELIVERY

Main unit	1 pc
Power supply adapter	1 pc
TYPE-C cable	1 pc
16G TF card	1 pc

SPECIFICATION

IR image	IR resolution	120×90@17μm
	detector type	VOx/7.5~14μm
	frame rate	25Hz/9Hz
	thermal sensitivity/NETD	60mk
	focal length	2.28mm/F1.13
	field of view (FOV)	50°×38°
	spatial resolution (IFOV)	7.6mrad
Visible camera	focus	focus-free
	visible camera resolution	320×240, focus-free
Image display	flashlight	yes
	display	2.4 inch IPS technology TFT display
	display resolution	320×240
	image model	IR/visible/picture-in-picture
Temperature measurement	color palettes	6: white hot, iron red, hot iron, arctic, rainbow 1, rainbow 2
	temperature range	-20~150°C, 100~400°C (auto switching)
	accuracy	±2°C or ±2%, whichever is greater (target temp ≥0°C, ambient temp is 15~30°C)
	measurement spot	center spot
	measurement area	3 (incl. max & min temp)
	auto max & min spot tracking	yes
Image storage	alarm	full screen max & min spot alarm
	storage media	TF card (16G)
	IR image format	full radiometric (JPG) (120 x 90)
Connections & communications	visible image	yes, 320x240
	USB	type-C, TF card slot
	tripod interface	yes
	mobile APP	yes
Power system	PC IR analysis software	yes
	battery type	rechargeable li ion battery
	battery operation time	>5 hours
Environmental parameters	charging time	internal charge, ≤2.5 hours
	operation temperature	-10~50°C
	storage temperature	-40~70°C
	protection	IP54, 2-meter drop test
	certification	CE/ROHS/FCC
	dimension (LxWxH)	194×61.5×76mm
	weight	350g

DIGITAL THERMOHYGROMETER CODE 9362-TH27

- Measure humidity, ambient temperature and dew-point temperature
- Max/Min/Average mode
- Alarm function

SPECIFICATION

Sensor	NTC thermistor/humidity capacitance/digital sensor
Temperature range	-20°C~70°C/-4°F~158°F
Temperature accuracy	±0.5°C/±0.9°F
Temperature resolution	0.1°C/0.2°F (minimum adjustable unit is 0.2°F in setting mode)
Humidity range	0~100%RH
Humidity accuracy	±5%RH
Humidity resolution	0.1%RH
Sampling interval	5s
Battery	1.5V AAA
Dimensions	95×107×18mm
Weight	105g



STANDARD DELIVERY

Main unit	1 pc
Battery (AAA)	1 pc

DATA LOGGER FOR TEMPERATURE AND HUMIDITY (BUILT-IN SENSOR) CODE 0311-3070



IP54
WATERPROOF

DATA
OUTPUT

- Signal acquisition, display, storage, analysis function
- Low power consumption
- Built-in high-precision temperature and humidity sensor
- Software is included

SPECIFICATION

Temperature range	-30°C~70°C/-22°F~158°F
Temperature accuracy	±0.3°C (at 23°C±2°C), other range ±0.5°C ±0.6°F (at 73.4°F±3.6°F), other range ±0.9°F
Temperature resolution	0.1°C/0.2°F
Humidity range	0%RH~100%RH
Humidity accuracy	±3%RH (at 10%RH~85%RH), other range ±5%RH
Humidity resolution	0.1%RH
Memory capacity	10918
Alarm	function: alarm when over high or low limit method: display+buzz+backlight
Sampling interval	2s, 5s, 10s, 30s, 60s, 255s (adjustable)
Logging interval	2 seconds~24 hours (adjustable)
Start with delay	1~120 seconds (adjustable)
Start mode	start immediately/delay start/timing start
End mode	full/FIFO/preset/timing end
Timing start/end	random start/end with format YYMMDD HHMMSS
Interface	USB
Time battery	CR2032
Power supply	3.2V lithium battery or 5~24V DC
Dimensions	123×117×33mm
Weight	260g

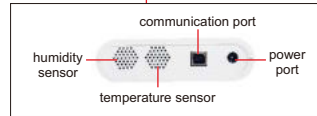

stand (included)

software (included), record and download data to PC software via USB cable

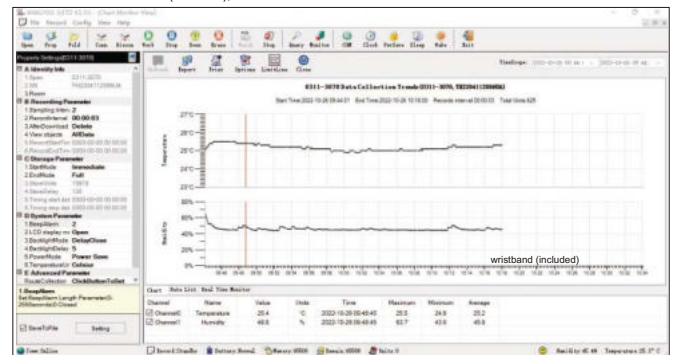

STANDARD DELIVERY

Main unit	1 pc
Software and USB cable	1 pc
Time battery	1 pc
Lithium battery	1 pc
Screwdriver	1 pc

OPTIONAL ACCESSORY

Power adapter	0311-3070-ADAPTER
---------------	-------------------

THERMOHYGROMETER CODE 0310-H26

- Measure humidity, ambient temperature, dew point temperature and wet bulb temperature
- Min/Max, data hold function
- Bluetooth 4.0
- Auto power off

SPECIFICATION

Function	Measuring range	Resolution	Accuracy
Ambient temperature	0°C~50°C 32°F~122°F	0.1°C/0.1°F	±1.0°C/±1.8°F
Wet bulb temperature	0°C~50°C 32°F~122°F		
Dew point temperature	0°C~50°C 32°F~122°F		
Humidity	0%RH~80%RH	0.1%RH	±5.0%RH
Auto power off	30 minutes		
Data port	Bluetooth 4.0		
Power supply	9V battery		
Dimension	204×54×36mm		
Weight	172g		



App measurement



App record

No.	Time	Temp (°C)	Humidity (%)
1	21:00	21.40	61.40
2	21:05	20.50	58.50
3	21:10	19.50	55.50
4	21:15	18.50	52.50
5	21:20	17.50	49.50
6	21:25	16.50	46.50
7	21:30	15.50	43.50
8	21:35	14.50	40.50
9	21:40	13.50	37.50
10	21:45	12.50	34.50
11	21:50	11.50	31.50

STANDARD DELIVERY

Main unit	1 pc
Battery	1 pc

ANEMOMETER CODE 0110-1125

- Measure air velocity and temperature
- Min/Max, data hold function
- Bluetooth 4.0
- Auto power off



App measurement



App record

No.	Data Value	Data Value
	°C	(m/s)
1	23.10	0.22
2	23.10	0.09
3	23.00	0.00
4	23.10	4.19
5	23.10	1.80
6	23.00	1.68
7	23.00	0.72
8	23.00	0.44
9

SPECIFICATION

	Unit	Measuring range	Resolution	Accuracy
Air velocity	m/s	1.1~25.0	0.01	±(3%+0.3)
	km/h	4~90	0.1	±(3%+1)
	ft/min	220~4920	1	±(3%+40)
	MPH	2.5~56.0	0.1	±(3%+0.4)
	knots	2.2~48.0	0.1	
Air temperature	°C	0~50	0.1	±2
	°F	32~122	0.1	±4
Sensors	air velocity sensor, NTC-type precision thermistor			
Sampling time	0.5s			
Operation altitude	max 2000m			
Operation environment	0~50°C, 0~80%RH			
Storage environment	-10~60°C, 0~80%RH			
Auto power off	10 minutes			
Data port	Bluetooth 4.0			
Power supply	9V			
Dimension	213×54×36mm			
Weight	172g			

STANDARD DELIVERY

Main unit	1 pc
Battery	1 pc

LIGHT METER (BASIC TYPE) CODE 0130-L110

- Suitable for measuring illuminance in various occasions
- Data hold function
- Fast switching of measuring range, easy to operate



SPECIFICATION

Measuring range	Lux	1~1999	10~19990	100~100000
Resolution	Lux	1	10	100
Accuracy	± (4%+10d), range<10000Lux ± (5%+10d), range≥10000Lux (d is resolution, calibrated with standard incandescent lamp at color temperature 2856K)			
Repeatability	±2%			
Sampling time	0.5s			
Operation environment	0~40°C, 0~70%RH			
Storage environment	-10~50°C, 0~80%RH			
Battery	9V			
Photodetector dimension	105×58×28mm			
Main unit dimension	130×72×30mm			
Weight	170g			

STANDARD DELIVERY

Main unit	1 pc
Battery	1 pc

LIGHT METER CODE 0131-A120

- Photosensor can rotate 90° clockwise and rotate 180° counterclockwise
- Build-in calibration filters ensure the accuracy when working in different colors
- Data hold function
- Lux/FC unit switch
- Low battery warning

SPECIFICATION

Measuring range	Lux	0.1~199.9	1~1999	10~19990	100~199900
Resolution	Lux	0.1	1	10	100
Measuring range	FC	0.01~19.99	0.1~199.9	1~1999	10~19990
Resolution	FC	0.01	0.1	1	10
Accuracy	±(4%+10d), range<20000Lux/2000FC ±(5%+10d), range≥20000Lux/2000FC (d is resolution, calibrated with standard incandescent lamp at color temperature 2856K)				
Repeatability	±2%				
Sampling time	0.5s				
Operation environment	0~40°C, 0~70%RH				
Storage environment	-10~50°C, 0~80%RH				
Battery	9V				
Dimension	185×68×38mm				
Weight	130g				



STANDARD DELIVERY

Main unit	1 pc
Battery	1 pc

INDUCTIVE MOISTURE METER CODE 0120-IM24

- Suitable for wood, gypsum and cement
- MAX/MIN/HOLD mode
- Alarm function
- Low battery indication
- Auto power off

SPECIFICATION

Measuring range	0~100%
Resolution	1%
Accuracy	±4%
Detection depth	20~40mm
Sampling time	0.5s
Battery	9V
Dimension	185×55×38mm
Weight	193g



STANDARD DELIVERY

Main unit	1 pc
Battery	1 pc

SOUND LEVEL METER CODE 0010-A35

- Auto range selection
- Over range indication
- Display backlight
- Min/Max, data hold function
- Bluetooth 4.0
- Auto power off
- Supplied with APP for Apple and Android

SPECIFICATION

Frequency	31.5Hz~8KHz
Measuring Range	35dB~130dB
Accuracy	IEC 61672-1:2013 Class 2
Resolution	0.1dB
Frequency weighting	A and C
Display update	2 times/sec
Microphone	1/2 inch electret condenser microphone
Power supply	9V battery
Operation temperature and humidity	0°C~40°C/32°F~104°F, 10%RH~90%RH
Dimensions	185×54×36mm
Weight	184g



STANDARD DELIVERY

Main unit	1 pc
Battery	1 pc
Windscreen	1 pc

App measurement



App record

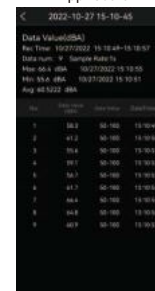

DIGITAL SOUND LEVEL METER (ADVANCED TYPE) CODE 9353-413

SPECIFICATION

Measuring range	40dB~130dB (ref.20μPa)
Frequency	20Hz~12.5kHz
Resolution	0.1dB
Accuracy	IEC 61672-1:2013 Class 2
Frequency weighting	A weighting
Response time	fast (125ms), slow (1s)
Microphone	pre polarization condenser microphone
Reference direction	axial direction of condenser microphone
Power supply	4×1.5V AAA batteries
Dimension	210×68×27mm
Weight	240g



- Automatic range conversion
- Over range indicator
- Maximum mode
- Data hold
- AC signal output: 0.707Vrms, impedance approx.100Ω
- DC signal output: 20mV/dB, impedance approx.1kΩ

STANDARD DELIVERY

Main unit	1 pc
Battery (AAA)	4 pcs
Screwdriver	1 pc

CONTACT TACHOMETER CODE 9224-213



STANDARD DELIVERY

Main unit	1 pc
Wheel with 0.1m perimeter	1 pc
Clamping sleeve	1 pc
Cone head	1 pc
Small cone head	1 pc
Cone cavity head	1 pc
Battery (AA)	3 pcs



- Can measure rotary speed, line speed and line length
- Automatically save the maximum value, minimum value and the last value, 96 data can be stored during continuous measurement
- With backlight display

SPECIFICATION

Measuring range	rotary speed	0.5~19999RPM
	line speed	0.05~500m/min
	line length	0.05~99999m
Resolution	rotary speed	0.1RPM (range 0.5~999.9RPM) 1RPM (range 1000~19999RPM)
	line speed	0.01m/min (range 0.05~99.99m/min) 0.1m/min (range 100~500m/min)
	line length	0.02m
Accuracy	rotary speed	±(0.4%n+1d)RPM (n<300RPM) ±(0.05%n+1d)RPM (n≥300RPM) n is rotary speed, d is resolution
	line speed	±(1%+1d)m/min d is resolution
	line length	±(1%+1d)m d is resolution
Sampling time		0.8s (above 60RPM)
Operation temperature		0~40°C
Power supply		3×AA batteries
Dimension		171×71×35mm
Weight		162g

NON-CONTACT TACHOMETER CODE 9223-120



- Accurately measure the rotary speed without contact
- Automatically save the maximum value, minimum value and the last value, 500 data can be stored during continuous measurement

SPECIFICATION

Measuring range	2.5~99999RPM
Resolution	0.1RPM (range 2.5~999.9RPM) 1RPM (range 1000~99999RPM)
Accuracy	$\pm(0.05\%n+1d)$ RPM n is rotary speed, d is resolution
Laser power	Class 3R, 3mW~4mW
Sampling time	0.6 second (above 100RPM)
Measuring distance	50~500mm
Operation temperature	0~40°C
Power supply	3×AA batteries
Dimension	180×71×29.9mm
Weight	145g



reflection sticker
(included)

STANDARD DELIVERY

Main unit	1 pc
Reflection sticker	3 pcs
Battery (AA)	3 pcs



CONTACT/NON-CONTACT TACHOMETER CODE 9225-405



- 2 measuring method, contact and non-contact
- Can measure rotary speed and line speed
- Automatically save the maximum value, minimum value and the last value, 500 data can be stored during continuous measurement
- Automatic power off



cone cavity head (included)



small cone head (included)



wheel with 0.1m perimeter (included)



cone head (included)



clamping sleeve (included)



reflection sticker (included)

SPECIFICATION

Measuring method		Non-contact	Contact
Measuring range	rotary speed	2.5~99999RPM	0.5~19999RPM
	line speed	—	0.05~500m/min
Resolution	rotary speed	0.1RPM (range 2.5~999.9RPM) 1RPM (range 1000~99999RPM)	0.1RPM (range 0.5~999.9RPM) 1RPM (range 1000~19999RPM)
	line speed	—	0.01m/min (range 0.05~99.99m/min) 0.1m/min (range 100~500m/min)
Accuracy	rotary speed	$\pm(0.05\%n+1d)$ RPM n is rotary speed, d is resolution	$\pm(0.4\%n+1d)$ RPM (n<300RPM) $\pm(0.05\%n+1d)$ RPM (n≥300RPM) n is rotary speed, d is resolution
	line speed	—	$\pm(1\%+1d)$ m/min d is resolution
Laser power		Class 3R, 3mW~4mW	—
Sampling time		0.6s (above 100RPM)	—
Measuring distance		50~500mm	—
Operation temperature		0~40°C	—
Power supply		3×AA batteries	—
Dimension		206×71×36mm	—
Weight		170g	—

STANDARD DELIVERY

Main unit	1 pc
Reflection sticker	3 pcs
Wheel with 0.1m perimeter	1 pc
Clamping sleeve	1 pc
Cone head	1 pc
Small cone head	1 pc
Cone cavity head	1 pc
Battery (AA)	3 pcs



SPECTROPHOTOMETER CODE 5701-D40

THREE KINDS
OF APERTURE

MATCHING COLOR
CARD QUICKLY

GRATING
SPECTROPHOTOMETRIC

DATA
OUTPUT

connect to computer



computer is optional



measurement



- Conforms with CIE No.15, ISO7724-1, ASTM E1164 and DIN5033 Teil7 standards
- 3.5"IPS full color screen
- Use long life and low power consumption combined LED light source, include UV and exclude UV measurement
- Camera locating function, switchable 11mm/6mm/1×3mm aperture
- Large capacity storage space, over 20,000 measurement data
- Two standard observer angles, a variety of illuminant, a variety of color indexes, conforms with a variety of standard colorimetric data
- Measure sample spectra, accurate Lab data, can be used in color matching and accurate color transmission

white calibration cavity (included)



software (included), test can be controlled from the software, display test data, report

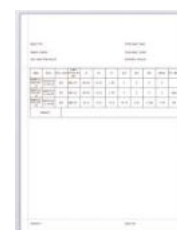

text report

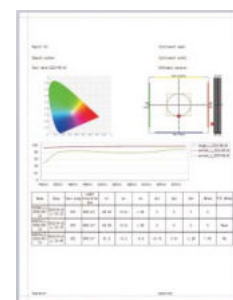

graphic report

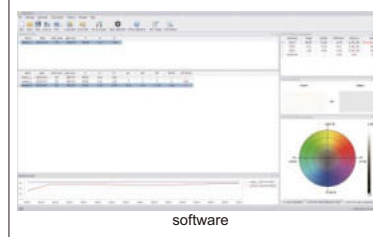

software

SPECIFICATION

Optical geometry	D/8 (diffused illumination/8° direction reception) SCI+SCE (specular component included+specular component excluded)	
Integrating sphere size	Ø40mm	
Light source	LED (full band balanced LED) +UV	
Spectrophotometric mode	grating	
Sensor	dual optical path high precise CMOS array sensor	
Wavelength range	400~700nm	
Wavelength interval	10nm	
Reflectance measurement range	0~200%	
Reflectance resolution	0.01%	
Display resolution	0.01	
Illumination area/Aperture	MAV:Ø11mm; SAV:Ø6mm; MINI:1×3mm	
Color space	CIE-Lab, CIE-LCh, HunterLab, CIE Luv, XYZ, Yxy, RGB	
Color difference formula	ΔE^*ab , ΔE^*cmc , ΔE^*94 , ΔE^*00	
Other colorimetric index	Whiteness (ASTM E313-00, ASTM E313-73, CIE/ISO, AATCC, Hunter, Taube Berger Stensby), Yellowness (ASTM D1925, ASTM 313-00, ASTM E313-73), Blackness (My, dM), Color fastness, Tint (ASTM E313-73) Color density CMYK (A, T, E, M), Milm, Munsell, Opacity, Color strength	
Observer angle	2°/10°	
Illuminant	A, B, C, D50, D55, D65, D75, F1, F2, F3, F4, F5, F6, F7, F8, F9, F10, F11, F12, CWF, U30, U35, DLF, NBF, T183, T184, Id50, Id65, LED-B1, LED-B2, LED-B3, LED-B4, LED-B5, LED-BH1, LED-RGB1, LED-V1, LED-V2	
Measuring time	about 1.5s	
Repeatability	spectral reflectance	within 0.08% of standard deviation
	colorimetric values	$\Delta E^*ab \leq 0.025$ (after whiteboard correction, measuring the whiteboard 30 times at 5s interval)
Inter-instrument error	$\Delta E^*ab \leq 0.25$ (BCRA series II, average value of 12 color plates)	
Output	USB, Bluetooth	
Light source lifetime	10 years, more than 1 million times measurements	
Battery	3.7V/3000mAh, rechargeable 8,000 times continuous tests	
Dimension	95×129×231mm	
Weight	750g	

STANDARD DELIVERY

Main unit	1 pc
White calibration cavity	1 pc
Measuring aperture	3 pcs
USB cable	1 pc
USB disk	1 pc
AC/DC adapter	1 pc

COLORIMETER (BASIC TYPE) CODE 5700-LS35



- Conforms with CIE 15, CIE S 005, ISO 7724-1 and ISO 13655 standards
- 3.5-inch IPS display and capacity touch panel
- Contains multiple color cards and can match the closest color code quickly
- QC testing function, can set color difference threshold
- Able to store 1000 colors and 1000 color comparison
- 3.7V/4000mAh battery, 10000 continuous measurements

SPECIFICATION

Illumination geometry	D/8, specular component include (SCI)
Illumination light source	full spectrum LED light source
Measurement conditions	light source D65, field of view 10°
Measuring time	about 1s
Color space	CIE Lab, Luv, LCh, Yxy, CMYK, RGB, Hex
Color difference formula	ΔE^*ab , ΔE^*uv , ΔE^*94 , ΔE^*cmc (2:1), ΔE^*cmc (1:1), ΔE^*00
Repeatability	standard deviation ΔE^*ab is within 0.03 (measurement condition: the average value of 30 measurements on the whiteboard at an interval of 3s after calibration)
Charging interface	USB (Type-C)
Dimension	86×63×158mm
Weight	245g



STANDARD DELIVERY

Main unit	1 pc
White calibration cavity	1 pc
USB cable	1 pc
AC/DC adapter	1 pc
Cleaning cloth	1 pc
Locating plate	1 pc



white calibration cavity
(included)

60° GLOSS METER CODE ISQ-DG6



- To test the gloss of coating, such as painting, varnish, printing ink, etc.
- To test the material surfaces, such as metal, granite, ceramic, plastic, paper, etc.
- According to ISO 2813, ASTM D2457, ASTM D523
- Automatic power off

SPECIFICATION

Incidence angle	60°
Measuring range	0~150GU
Resolution	0.1GU
Accuracy	±1.2GU
Repeatability	0.4GU
Zero set error	0.2GU
Measuring area	20×10mm
Output	bluetooth
Power supply	1×1.5V AA battery
Dimension	123×38×65mm
Weight	300g



base with calibration block
(included)



connect mobile phone via bluetooth
(only Android system)



operate and output data by mobile phone

STANDARD DELIVERY

Main unit	1 pc
Base with calibration block	1 pc
Spare calibration block	1 pc

20°/60°/85° GLOSS METER CODE ISQ-DG8

- To test the gloss of coating, such as painting, varnish, printing ink, etc.
- To test the material surfaces, such as metal, granite, ceramic, plastic, paper, etc.
- According to ISO 2813, ASTM D2457, ASTM D523
- Memory of 10000 measurement results for browsing and output
- Automatic power off

software (included), test can be controlled from the software, display test data, output to Excel

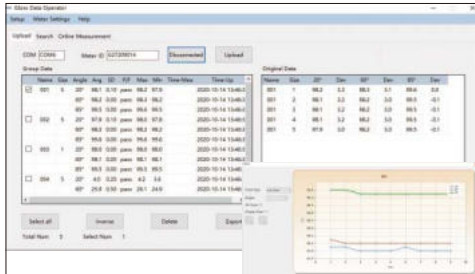

base with calibration block (included)



CAN BE OPERATED BY
COMPUTERS OR MOBILE PHONES

DATA
OUTPUT

BLUETOOTH

software CD (included)



connect to mobile phone via bluetooth (only Android system)



operate and output data by mobile phone

SPECIFICATION

Incidence angle	20°	60°	85°
Measuring range	0~2000GU	0~1000GU	0~160GU
Resolution	0.1GU (range≤119.9GU)		
	1GU (range>119.9GU)		
Accuracy	±1.5GU (range≤119.9GU)		
	±1.5% (range>119.9GU)		
Repeatability	0.2GU (range≤119.9GU)		
	0.2% (range>119.9GU)		
Zero set error	0.2GU		
Measuring area	10×9mm	16×9mm	39×5mm
Output	USB and bluetooth		
Power supply	1×1.5V AA battery		
Dimension	155×48×75mm		
Weight	400g		

connect to computer via bluetooth or USB cable

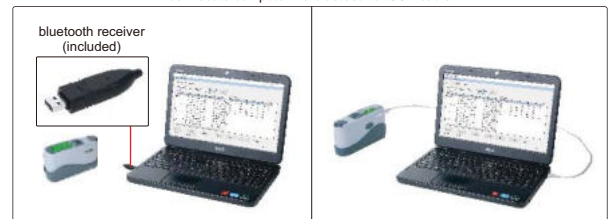

STANDARD DELIVERY

Main unit	1 pc
Base with calibration block	1 pc
Software and USB cable	1 pc
Bluetooth receiver	1 pc

60° GLOSS METER (BASIC TYPE) CODE 5702-DG6

- To test the gloss of coating, such as painting, varnish, printing ink, etc.
- To test the material surfaces, such as metal, granite, ceramic, plastic, paper, etc.
- According to ISO 2813, ISO 7668, ASTM D523, ASTM D2457, DIN 67530
- Automatic judgement after setting high and low limits
- Automatic power off



software (included), test can be controlled from the software, display test data and report

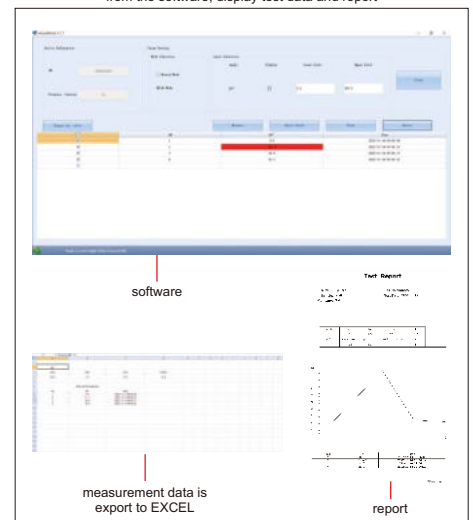

software

Test Report

measurement data is export to EXCEL

report



base with calibration block (included)

STANDARD DELIVERY

Main unit	1 pc
Base with calibration block	1 pc
U disk	1 pc
AC/DC adapter	1 pc
USB data cable	1 pc
Cleaning cloth	1 pc

SPECIFICATION

Incidence angle	60°
Measuring range	0~200GU
Resolution	0.1GU
Accuracy	±1.5GU (range<120GU)
	±1.5% (range≥120GU)
Repeatability	0.2GU (range<120GU)
	0.2% (range≥120GU)
Zero error	0.1GU
Measuring area	20×10mm
Power supply	rechargeable battery
Data port	USB
Dimension	135×45×75mm
Weight	237g

**VIBRATION PEN
CODE 9720-199**



- Measure vibration of motors, fans, pumps, compressors and machine tools to prevent mechanical failure
- Small size, light weight, low energy consumption, easy operation, easy to carry
- One key control
- Automatic power off

STANDARD DELIVERY

Main unit	1 pc
LR44 battery	2 pcs

SPECIFICATION

Code	9720-199
Measured parameter	speed
Measuring range	0.1~199.9mm/s
Frequency	10Hz~1KHz
Accuracy	±(5%±2)mm/s
Operation temperature	0°C~40°C
Operation humidity	<85%
Power supply	2×LR44 batteries (for 10 hours working)
Dimension	150x22x18mm
Weight	55g

**VIBRATION PEN (THREE PARAMETERS)
CODE 0020-A199**



- Acceleration, velocity and displacement can be tested
- Automatic power off

STANDARD DELIVERY

Main unit	1 pc
LR44 battery	2 pcs

SPECIFICATION

Parameter	acceleration	velocity	displacement
Measuring range	0.01~199.9m/s ² (peak value)	0.01~199.9mm/s (virtual value)	0.001~1.999mm (peak-peak value)
Frequency	10Hz~1kHz	10Hz~1kHz	10Hz~500Hz
Frequency response	±5% (≥20Hz) -20%~+10% (<20Hz)		
Linearity	±(5%+2unit)		
Indeterminacy of sensitivity	≤3%		
Operation temperature	0°C~40°C/32°F~104°F		
Operation humidity	<85%		
Power supply	2×LR44 battery (for 10 hours working)		
Dimension	150x22x18mm		
Weight	55g		

**DIGITAL REFRACTOMETER
CODE ISQ-DRM31**



SUITABLE FOR WATER
BASED COOLANT

- Quickly measure the concentration of coolant
- Two measurement modes: single measurement and automatic average multiple measurement
- Two units: brix and refractive index
- Refer to the refraction factor of coolant, for example: the refraction factor of grinding emulsion is 2.1, the reading value is 6%, so the actual concentration is (2.1×6%)=12.6%
- Automatic power off



SPECIFICATION

Measuring range	0~50% (1.3330~1.4200RI)
Accuracy	±0.2% (±0.0003RI)
Resolution	0.1% (0.0001RI)
Power supply	1×AAA battery
Dimension	121×58×25mm
Weight	90g

STANDARD DELIVERY

Main unit	1 pc
Dropper	1 pc
Battery (AAA)	1 pc

dropper (included)



**PORTABLE REFRACTOMETER
CODE ISQ-RM30**



SUITABLE FOR WATER
BASED COOLANT

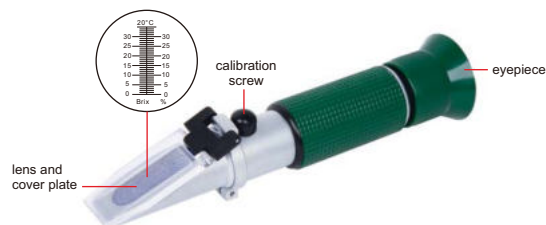

- Quickly measure the concentration of coolant
- Refer to the refraction factor of coolant, for example: the refraction factor of grinding emulsion is 2.1, the reading value is 6%, so the actual concentration is (2.1×6%)=12.6%

SPECIFICATION

Measuring range	0~32%
Graduation	0.2%
Dimension	27×40×160mm
Weight	175g

DIGITAL STOPWATCH CODE DSW-A010

- Split time, total time and continuous time can be displayed
- 10 groups of results can be read out from memory after resetting
- Scroll back and forth to read out the memory digits
- The fastest, slowest and average time can be displayed
- Able to record the split times (00-199)



SPECIFICATION

Measuring range	0~9 hour, 59 minutes, 59.99 seconds	
Resolution	0.01s	
Accuracy	±0.5s	
Function	memory	10 groups
	timer	up to 10 hours
	time	12-hour or 24-hour time display, alarm can be set
Power supply	LR44 battery	
Screen dimension	33.6×13.6mm	
Dimension	76×63×16mm (metal case)	

STANDARD DELIVERY

Main unit	1 pc
String	1 pc

STROKE COUNTER CODE 7600-6

- Accumulate and record the number of mechanical movements
- Rotate back to zero

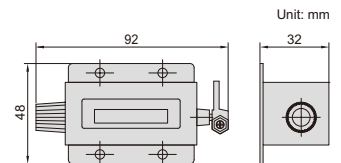

SPECIFICATION

Code	Number of digits	Range
7600-6	6	0-999999

DIGITAL VOLTAGE TESTER CODE 9721-250

- Direct AC test (contact): 12-250V two way display: voltage displays on LCD screen and neon lamp lights up (when voltage>80V)
- Induction AC test (non-contact): 12-250V to detect power source or recognize the phase line, ground line and break point
- Direct DC test (contact): 6-36V instant sense and display
- Work without battery
- Tester tip: CRV material



SPECIFICATION

Range	AC: 12-250V; DC: 6-36V
Neon lamp life	30000 times
Dimension	133×21×19mm
Weight	22g



VOLTAGE TESTER CODE 9722-250

- Tester tip: CRV material



SPECIFICATION

Range	AC: 100-250V
Neon lamp life	30000 times
Dimension	145×Ø15mm
Weight	21g

AC PHASE AND VOLTAGE DETECTOR CODE 9723-400



9723-400

- Non-contact detection of phase sequence, high and low voltage, wire distinction
- Low battery indication
- Auto power off
- Flashlight

SPECIFICATION

Phase sequence detection	screen display clockwise or counterclockwise
High and low voltage detection	beep: slow-fast backlight: green~red analog bar: low~high
Wire distinction	green backlight indicates neutral wire red backlight indicates live wire
Power supply	2×1.5V AAA batteries
Dimension	157×27×23mm
Weight	32g

PEN-TYPE DIGITAL MULTIMETER CODE 9241-ML200



- Auto/manual ranging
- Maximum mode
- Data hold
- Low battery display
- Auto power off
- Safety rating: CAT III 600V



probe (included)



SPECIFICATION

Function	Range	Resolution	Accuracy
DC Voltage	200mV/2V/20V/200V/600V	0.1mV/1mV/10mV/0.1V/1V	±(0.7%+2)
	200mV/2V/20V/200V	0.1mV/1mV/10mV/0.1V	±(0.8%+3)
AC Voltage	600V	1V	±(1.0%+3)
DC Current	20mA/200mA	10µA/0.1mA	±(1.5%+3)
AC Current	20mA/200mA	10µA/0.1mA	±(2.0%+3)
Resistance	200Ω	0.1Ω	±(1.0%+3)
	2kΩ/20kΩ/200kΩ/2MΩ	1Ω/10Ω/0.1kΩ/1kΩ	±(1.0%+1)
	20MΩ	10kΩ	±(1.0%+5)
Logic level test	<1.5V (green LED on) 1.5~3.5V (green & red LED off) >3.5V (red LED on)		
Diode	open circuit voltage 1.5V		
Continuity buzzer	<50Ω		
Power supply	2×1.5V AAA batteries		



clips (included)

STANDARD DELIVERY

Main unit	1 pc
Probe	1 pc
Clip	2 pcs
1.5V battery	2 pcs

SMART DIGITAL MULTIMETER CODE 9247-190



- Automatically identify test mode for AC voltage/DC voltage/resistance/continuity
- Non-connection AC voltage detection, and judge the strength by light and buzzer
- Self-calibration when power on to ensure accuracy
- LIVE firewire recognition
- Display backlight
- True RMS
- Data hold
- Low battery display
- Automatic power off
- Safety rating: CAT III 600V



probes (included)



STANDARD DELIVERY

Main unit	1 pc
Probe	2 pcs
Battery (CR2032)	2 pcs

SPECIFICATION

Function	Range	Resolution	Accuracy
DC Voltage	60mV/600mV/6V/60V/600V	0.01mV/0.1mV/0.001V/0.01V/0.1V	±(0.5%+3)
AC Voltage	60mV/600mV/6V/60V/600V	0.01mV/0.1mV/0.001V/0.01V/0.1V	±(1.0%+3)
DC Current	6000µA/60mA/600mA	1µA/0.01mA/0.1mA	±(1.2%+5)
AC Current	6000µA/60mA/600mA	1µA/0.01mA/0.1mA	±(1.5%+5)
Resistance	600Ω/6kΩ/60kΩ/600kΩ	0.1Ω/0.001kΩ/0.01kΩ/0.1kΩ	±(1.0%+5)
	6MΩ/60MΩ	0.001MΩ/0.01MΩ	±(1.5%+3)
Capacitance	6nF/60nF/600nF/6µF/60µF/600µF	0.001nF/0.01nF/0.1nF/0.001µF/0.01µF/0.1µF	±(4.0%+5)
	6mF/60mF	0.001mF/0.01mF	±(5.0%+5)
Frequency	10Hz/100Hz/1000Hz/10kHz/100kHz/1000kHz	0.001Hz/0.01Hz/0.1Hz/0.001kHz/0.01kHz/0.1kHz	±(1.0%+5)
	10MHz	0.001MHz	±(3.0%+5)
Duty	1~99%	0.1%	±(3.0%+5)
Diode measurement	open circuit voltage 2.0V		
Continuity measurement	<50Ω		
Power	2×3V CR2032 batteries		
Dimension (LxWxH)	133×68×18mm		
Weight	178g		

DIGITAL MULTIMETER (WITH JACK INDICATOR LIGHT) CODE 9246-180



- Jack indicator light: jacks flash green to indicate the corresponding jacks for probes
- Non-connection AC voltage detection and judge the strength by light and buzzer
- Self-calibration when power on to ensure accuracy
- LIVE firewire recognition
- Double color backlight (orange backlight prompts high voltage or current: the orange backlight automatically lights up when voltage is higher than 80V or the current is higher than 1A)
- Large range capacitance meter 100mF
- True RMS
- Battery test function
- Max/Min mode
- Data hold
- Low battery display
- Automatic power off
- Safety rating: CAT III 1000V, CAT IV 600V



probes (included)

STANDARD DELIVERY

Main unit	1 pc
Probe	2 pcs
Battery (AA)	2 pcs

SPECIFICATION

Function	Range	Resolution	Accuracy
DC Voltage	600mV/6V/60V/600V/1000V	0.1mV/0.001V/0.01V/0.1V/1V	±(0.5%+3)
AC Voltage	6V/60V/600V/750V	0.001V/0.01V/0.1V/1V	±(0.8%+5)
DC Current	60µA/60mA/600mA/10A	0.01µA/0.01mA/0.1mA/0.01A	±(1.2%+3)
AC Current	60mA/600mA/10A	0.01mA/0.1mA/0.01A	±(1.5%+3)
Resistance	600Ω/6kΩ/60kΩ/600kΩ	0.1Ω/0.001kΩ/0.01kΩ/0.1kΩ	±(1.0%+3)
	6MΩ/60MΩ	0.001MΩ/0.01MΩ	±(1.5%+3)
Capacitance	10nF/100nF/1000nF/10µF/100µF/1000µF	0.001nF/0.01nF/0.1nF/0.001µF/0.01µF/0.1µF	±(4.0%+5)
	10mF/100mF	0.001mF/0.01mF	±(5.0%+5)
Frequency	10Hz/100Hz/1000Hz/10kHz/100kHz/1000kHz	0.001Hz/0.01Hz/0.1Hz/0.001kHz/0.01kHz/0.1kHz	±(1.0%+3)
	10MHz	0.001MHz	±(3.0%+3)
Duty	1~99%	0.1%	±(3.0%+3)
Diode measurement	forward DC current 2.5mA, reverse DC voltage 3.0V		
Continuity measurement	<30Ω		
Power	2x1.5V AA batteries		
Dimension (LxWxH)	188x88x50mm		
Weight	424g		

DIGITAL MULTIMETER CODE 9242-ML100



SPECIFICATION

Function	Range	Resolution	Accuracy
DC Voltage	200mV/2V/20V/200V	0.1mV/1mV/10mV/0.1V	±(0.5%+3)
	600V	1V	±(0.8%+5)
AC Voltage	200V/600V	0.1V/1V	±(1.2%+10)
DC Current	200µA/2mA	0.1µA/1µA	±(1.0%+3)
	20mA	10µA	±(1.0%+5)
	200mA	0.1mA	±(1.5%+5)
	10A	10mA	±(3.0%+10)
Resistance	200Ω	0.1Ω	±(0.8%+5)
	2kΩ/20kΩ/200kΩ	1Ω/10Ω/0.1kΩ	±(0.8%+2)
	2MΩ	1kΩ	±(1.0%+5)
Diode	open circuit voltage 3.0V		
Continuity buzzer	<70±30Ω		
Transistor hFE	measuring range 0~1000		
Power supply	1x9V 6F22/NEDA 1604 battery		

- Data hold
- Display backlight
- Low battery display
- Safety rating: CAT II 600V



probes (included)



STANDARD DELIVERY

Main unit	1 pc
Probe	2 pcs
9V battery	1 pc

PORTABLE CONDUCTIVITY/TDS METER CODE 0411-0200



IP65
WATERPROOF

- Reading mode: auto-read and continuous-read
- Automatic/manual temperature compensation
- Auto-hold feature senses and locks the measurement endpoint
- Cell constant is settable
- 1 point calibration with standard recognition
- Data capacity up to 200 sets for each parameter
- IP65 dust/waterproof
- Auto power off

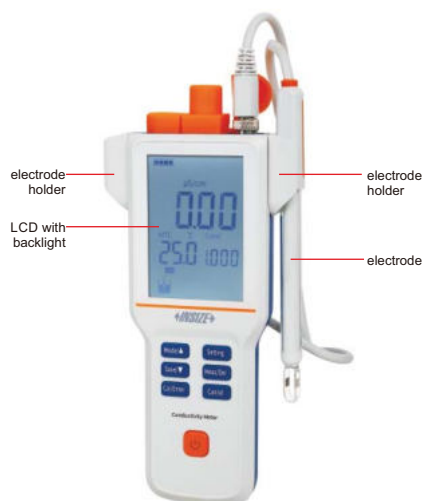

SPECIFICATION

Conductivity	range	0.00 μ S/cm~200mS/cm
	resolution	0.01 μ S/cm minimum
	accuracy	\pm 1.0%FS
	reference temperature	25°C/77°F
	calibration point	1
	standard recognition	84 μ S/cm, 1413 μ S/cm, 12.88mS/cm
TDS	range	0.00mg/L~300g/L
	resolution	0.01mg/L minimum
	accuracy	\pm 1.0%FS
Temperature	range	-5~110°C/23~230°F
	resolution	0.1°C/0.2°F
	accuracy	\pm 0.2°C/ \pm 0.4°F
Input	electrode with 5-pin aviation connector	
Power supply	rechargeable battery	
Dimension	80×225×35mm	
Weight	400g	

STANDARD DELIVERY

Main unit	1 pc
Electrode	1 pc
Electrode holder	2 pcs
Wristband	1 pc
Silicone rubber case	1 pc
AC/DC adapter and charging cable	1 pc
Standard solution	1 bottle

PORTABLE pH METER CODE 0431-0018



IP65
WATERPROOF

- Reading mode: auto-read and continuous-read
- Automatic/manual temperature compensation
- Auto-hold feature senses and locks the measurement endpoint
- 1 or 2 points calibration with standard recognition
- Data capacity up to 200 sets for each parameter
- IP65 dust/waterproof
- Auto power off



standard solution (included)



SPECIFICATION

pH	range	-2.00~18.00pH
	resolution	0.01pH
	accuracy	\pm 0.01pH
	calibration point	1 or 2
	standard recognition	NIST pH buffers: 4.01, 7.00, 10.01
Voltage	range	-1999~1999mV
	resolution	1mV
	accuracy	\pm 0.1%FS
Temperature	range	-5~110°C/23~230°F
	resolution	0.1°C/0.2°F
	accuracy	\pm 0.2°C/ \pm 0.4°F
Inputs	pH electrode: BNC (Q9) temp. probe: 4-pin aviation connector	
Power supply	rechargeable battery	
Dimension	80×225×35mm	
Weight	400g	

STANDARD DELIVERY

Main unit	1 pc
Electrode	1 pc
Electrode holder	2 pcs
Wristband	1 pc
Silicone rubber case	1 pc
AC/DC adapter and charging cable	1 pc
Standard solution	3 bottles
KCL powder	1 bottle

BOURDON TUBE PRESSURE GAGES (LIQUID FILLED)

CAN BE CUSTOMIZED

- Stainless steel case and bezel, copper alloy internals
- Shock-proof and pulse-proof
- Suitable for pneumatic system, hydraulic system and compressed air system

SPECIFICATION

Accuracy class	1.6
Ambient temperature	-20~60°C
Medium temperature	≤60°C

Dial size	Ø63mm		
Process connection	1/4BSP	1/4ZG	1/4NPT
Connector location	Bottom	Bottom	Bottom
Range (0~10bar/0~150psi)	5201-63B2Y10	5201-63Z2Y10	5201-63N2Y10



5201-63B2Y10

DIGITAL LEVEL CODE ISE-2DT

DATA OUTPUT



- Color LCD, touch panel
- X-Y axis measurement
- Set the tolerance and the display is shown in different colors

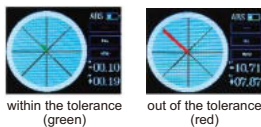

- To show the incline with line or bubble

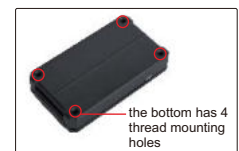
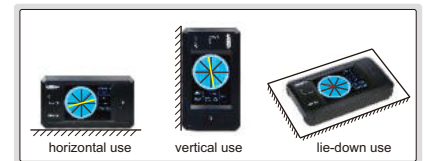
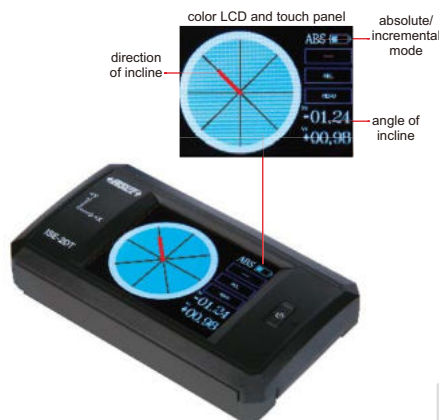
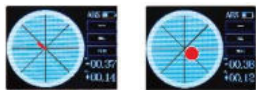

SPECIFICATION

Measuring range	±30°
Resolution	0.1°, 0.01°, 0.1mm/m
Accuracy	±0.03° (range 0~3°) ±0.05° (range >3°)
Power supply	rechargeable battery
Dimension	115×66×25mm
Weight	224g

STANDARD DELIVERY

Main unit	1 pc
USB cable	1 pc

OPTIONAL ACCESSORY

Software	ISE-2DT-SOFTWARE
----------	------------------

PC software (optional), send data to txt

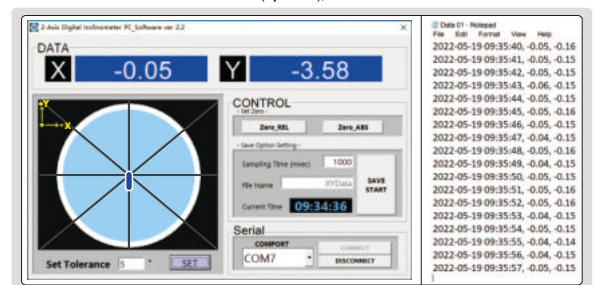

DIGITAL LEVEL AND SLOPE METER

WORKING TEMPERATURE
-5°C~50°C

IP67
WATERPROOF

ABSOLUTE
LEVEL

BACKLIGHT

BUZZER ALARM
AT 0° AND 90°



2175-360

- IP67 dust/waterproof
- Used as level and slope meter
- Aluminum frame, shock absorbing rubber end caps
- Magnetic bottom with V-groove for shafts
- The sea level is permanently set inside the chip, zero setting is not needed when batteries are replaced
- Buttons: ON/OFF, backlight/buzzer alarm, absolute and incremental measurement, unit (mm/m, %, °), HOLD (keep the reading)
- Three AAA batteries, automatic power off

Code	Range	Resolution	Accuracy
2175-360	0-360° (90°×4)	0.05° (=0.873mm/m)	at 0°: ±0.05°; at others: ±0.1°

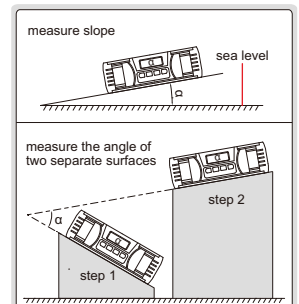
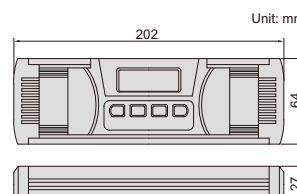

DIGITAL LEVEL AND SLOPE METER

WORKING TEMPERATURE
-5°C ~ 50°C

IP54
WATERPROOF

ABSOLUTE
LEVEL

BACKLIGHT

BUZZER ALARM
AT 0° AND 90°



2179-360

- IP54 dust/waterproof
- Used as level and slope meter
- Aluminum frame
- Magnetic bottom with V-groove for shafts
- The sea level is permanently set inside the chip, zero setting is not needed when battery is replaced
- Buttons: ON/OFF, absolute and incremental measurement, keep the reading, buzzer alarm, unit (mm/m, %, in/ft), conversion, backlight
- Two AAA batteries, automatic power off

Code	Range	Resolution	Accuracy
2179-360	0-360° (90°x4)	0.05° (=0.873mm/m)	at 0° and 90°: ±0.1°; at others: ±0.2°

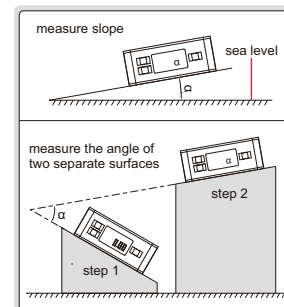
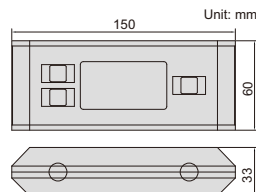

DIGITAL LEVEL AND SLOPE METER

ABSOLUTE
LEVEL

WORKING TEMPERATURE
-5°C~50°C

BACKLIGHT

DISPLAY FLIPS OVER WHEN
THE BOTTOM FACES UP

MAGNETIC
BOTTOM



2170-1

- Used as level and slope meter
- Aluminum frame, magnetic bottom
- The display flips over when the bottom faces up
- The backlight is on automatically when in use, and automatically off in 15 seconds after use
- The sea level is permanently set inside the chip, zero setting is not needed when battery is replaced
- Buttons: ON/OFF, ZERO, absolute and incremental measurement
- One AAA battery, automatic power off in 5 minutes

Code	Range	Resolution	Accuracy
2170-1	4x90°	0.1° (= 1.745 mm/m)	at 0° and 90°: ±0.1°; at others: ±0.2°

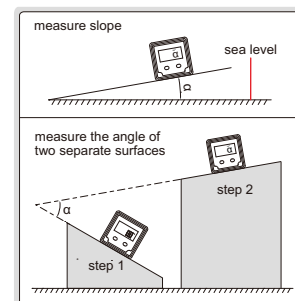
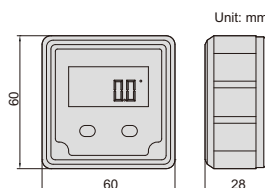

FRAME LEVELS



- V-groove on bottom and left for shafts (shafts dia. 15~68mm)
- With transverse vial

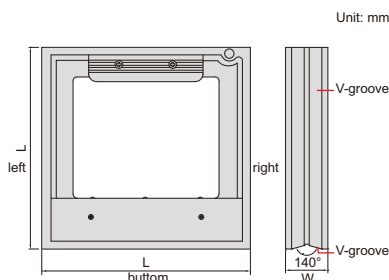

4902-200

Code		Size (LxL)	W
Sensitivity 0.02mm/m (=0.001°)	Sensitivity 0.05mm/m (=0.0029°)		
4902-150	4902-C150	150x150mm	40mm
4902-200	4902-C200	200x200mm	40mm
4902-300	4902-C300	300x300mm	45mm

BLOCK LEVELS



- V-groove on bottom for shafts (shafts dia. 15~68mm)
- With transverse vial



4903-200A

Code		Length (L)
Sensitivity 0.02mm/m (=0.001°)	Sensitivity 0.05mm/m (=0.0029°)	(mm)
4903-150A	4903-C150	150
4903-200A	4903-C200	200
4903-300A	4903-C300	300

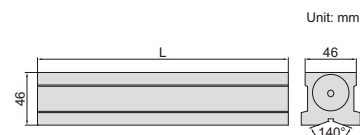

DIGITAL LEVELS AND SLOPE METERS

WORKING TEMPERATURE
0°C ~ 50°C

BACKLIGHT

ABSOLUTE LEVEL

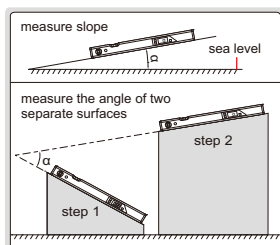

4910-400



4910-600

- With transverse and longitudinal vials
- Used as level and slope meter
- Aluminum frame, magnetic bottom
- The sea level is permanently set inside the chip, zero setting is not needed when batteries are replaced
- Buttons: ON/OFF, absolute and incremental measurement, keep the reading, buzzer alarm (not for 4910-400), unit (mm/m, %, in/ft), conversion (not for 4910-400), backlight
- The display flips over when the bottom faces up
- Two AAA batteries, automatic power off

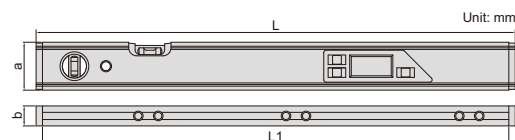

Code	Range	Resolution	Accuracy	Remark	L	L1	a	b
4910-400	0~360° (90°×4)	angle: 0.1°; slope: 1mm/m	±0.2°	both angle and slope are displayed	416mm	400mm	50mm	21mm
4910-600	0~360° (90°×4)	at 0° and 90°: 0.05° (=0.8725mm/m); at others: 0.1° (=1.745mm/m)	at 0° and 90°: ±0.1°; at others: ±0.2°	at 0° and 90° buzzer alarms	600mm	585mm	60mm	25mm

ALUMINUM ALLOY LEVELS

LIFETIME WARRANTY VIALS

- Accuracy: 0.5mm/m
- Top and bottom working surfaces
- Shock-proof and UV-proof vials
- Die casting aluminum alloy frame
- Zero position of horizontal vial can be set
- One graduation of horizontal vial is 2% slope
- Working temperature: -15°C~55°C



4911-600

Code	Length (L)
4911-600	600mm
4911-800	800mm

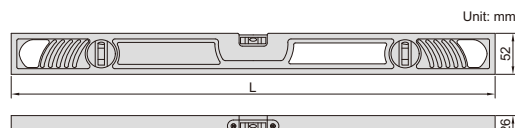
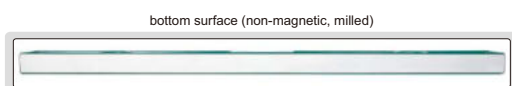

HANDY LEVEL



4912-100

- LIFETIME WARRANTY VIALS
- MAGNETIC BASE

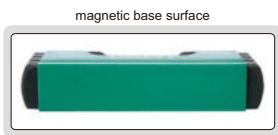
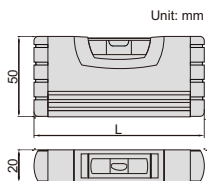

- Shockproof vials
- Magnetic base
- Shock absorbing rubber end caps
- Working temperature: -15°C~55°C

Code	Size (L)	Accuracy
4912-100	100mm	0.5mm/m

CAST ALUMINUM LEVEL

- LIFETIME WARRANTY VIALS
- MAGNETIC BASE



4913-250

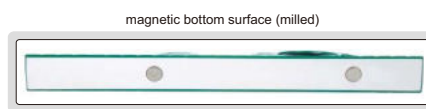
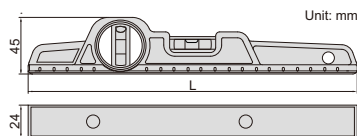

- Shockproof horizontal and vertical vials
- Magnetic base
- Working temperature: -15°C~55°C
- Cast aluminum body

Code	Size (L)	Accuracy
4913-250	250mm	0.5mm/m

ALUMINUM LEVELS

- LIFETIME WARRANTY VIALS
- MAGNETIC BASE



4914-600

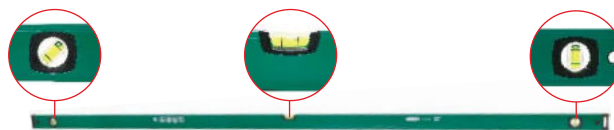

4914-2000

- Accuracy: 0.5mm/m
- Shockproof horizontal and vertical vials
- Magnetic base
- Shock absorbing rubber end caps
- Working temperature: -15°C~55°C

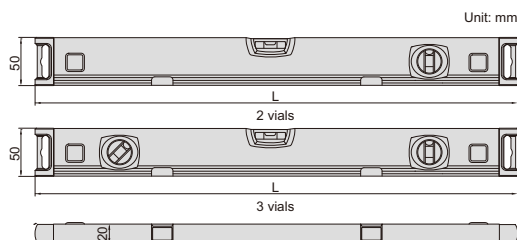
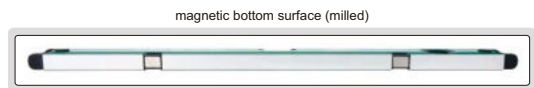

Code	Size (L)	Number of vials
4914-300	300mm	2
4914-600	600mm	2
4914-800	800mm	2
4914-1000	1000mm	2
4914-1200	1200mm	2
4914-2000	2000mm	3

ALUMINUM ALLOY LEVELS (WITH ROTARY VIAL)

- LIFETIME WARRANTY VIALS

- Shockproof and UV-proof vials
- Horizontal, vertical and rotary vials
- Rotary vial, range: 0°~360°, graduation: 5°
- Plumb window
- Shock absorbing rubber end caps
- Working temperature: -15°C~55°C



4920-600

rotary vial

vertical vial



Code	Length (L)	Accuracy
4920-400	400mm	0.5mm/m
4920-600	600mm	0.5mm/m
4920-800	800mm	0.5mm/m
4920-900	900mm	0.5mm/m
4920-1000	1000mm	0.5mm/m
4920-1200	1200mm	0.5mm/m

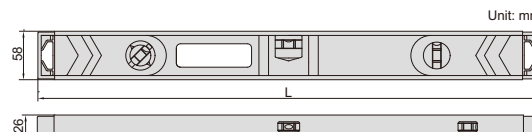

ALUMINUM ALLOY LEVELS (BASIC TYPE)

LIFETIME WARRANTY VIALS

MAGNETIC BASE



4918-300

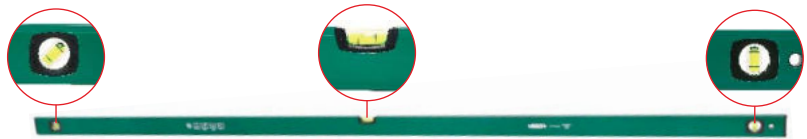

4918-2000

- Accuracy: 1mm/m
- Shock-proof and UV-proof vials
- Magnetic base
- Shock absorbing rubber end caps
- Working temperature: -15°C~55°C

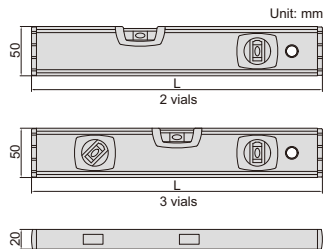

Code	Size (L)	Number of vials
4918-300	300mm	2
4918-600	600mm	2
4918-800	800mm	2
4918-1000	1000mm	2
4918-1200	1200mm	2
4918-2000	2000mm	3

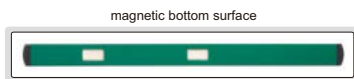

CROSS-LINE LASER LEVEL CODE 4917-30

IP54 WATERPROOF

AUDIBLE AND VISUAL WARNING WHEN OUT OF ±3°



- Red horizontal and vertical cross laser lines
- Self-leveling within ±3°, self-leveling time within 4s, "out of ±3°" audible and visual warning
- Folding legs for angle and height adjustment
- Outdoor use with the detector (code 4917-DETECTOR)



folding legs for angle and height adjustment

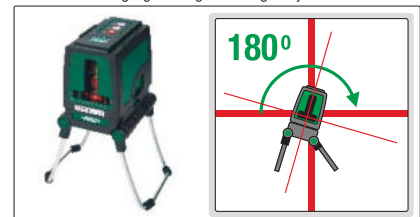

application examples



SPECIFICATION

Laser line width	2±0.5mm (within 5m)
Laser type	630~660nm, class II, <1mW
Beam angle	120±0.5°
Self-leveling range	±3°
Working distance	indoor: 30m, outdoor: 50m with detector (optional)
Accuracy	0.2mm/m
Operation temperature	-10~40°C
Power supply	3×AA batteries, for 3 hours operation
Dimension	100×82×104mm
Weight	620g

STANDARD DELIVERY

Main unit	1 pc
1/4" to 5/8" tripod adaptor	1 pc
Battery (AA)	3 pcs



outdoor detector (optional)



stand (included with outdoor detector)

OPTIONAL ACCESSORY

Outdoor detector	4917-DETECTOR
------------------	---------------

OUTDOOR DETECTOR (OPTIONAL)

Detecting distance	horizontal 1~50m, vertical 1~30m
Detecting accuracy*	high accuracy ±1.5mm, low accuracy ±2.5mm
Power supply	9V battery
Dimension	168×58×30mm
Weight	140g (battery included)

*Use high accuracy detection mode within 15m, use low accuracy detection mode over 15m

MOTORIZED DIGITAL ROCKWELL HARDNESS TESTER

FORCE LOADING BY ELECTRIC MOTOR (WITHOUT WEIGHTS)

DATA OUTPUT

INSPECTION CERTIFICATE



ISH-RSR400

- Automatic testing, the preliminary and main test force are loaded automatically
- LCD touch screen, easy operation
- Convert to other Rockwell scales, HV or HB automatically
- Tolerance testing
- Insert USB flash disk, save the testing results as Excel
- Self-correcting the hardness value for curved workpieces
- Force loading by electric motor (without weights)
- The test force is selected automatically according to hardness scale
- According to ISO 6508



SPECIFICATION

Code	ISH-RSR400	
Type	Rockwell	
Hardness scale	with standard indenters	HRA, HRB, HRC, HRD, HRF, HRG
	with optional indenters	HRE, HRH, HRK, HRL, HRM, HRP, HRR, HRS, HRV
Preliminary test force	98N/10kgf for Rockwell	
Test force	588N (60kg), 980N (100kg), 1471N (150kg)	
Stage elevation	manual	
Load control	automatic (load/dwell/unload)	
Load dwell time	0-60 second	
Resolution	0.1HR	
Output	USB	
Max. workpiece height	220mm	
Max. testing width	200mm (from the center of indenter to the wall of main body)	
Power supply	220V, 50/60Hz	
Dimension	510×260×780mm	
Weight	70kg	

STANDARD DELIVERY

Main unit	1 pc
Ø63mm flat anvil	1 pc
Ø150mm flat anvil	1 pc
V-type anvil	1 pc
Diamond indenter	1 pc
Ø1.5875mm carbide ball indenter	1 pc
Hardness test block HRB88-95	1 pc
Hardness test block HRC60-65	1 pc
Hardness test block HRC20-30	1 pc
USB flash disk (8G)	1 pc
Level	1 pc
Touch pen	1 pc
Anti-dust cover	1 pc

OPTIONAL ACCESSORY

Hardness test block HRB88-100	HDT-B-HRB
Hardness test block HRC60-70	HDT-B-HRC3
Hardness test block HRC20-30	HDT-B-HRC1
Hardness test block 78-88HR15N	HDT-B-HR15N2
Hardness test block 55-73HR30N	HDT-B-HR30N2
Hardness test block 73-82HR30T	HDT-B-HR30T
Small V-type anvil	ISH-SMALLANVIL
Desk	HDT-DESK

MOTORIZED DIGITAL ROCKWELL HARDNESS TESTER CODE ISH-MRD200

INSPECTION
CERTIFICATE

DATA
OUTPUT

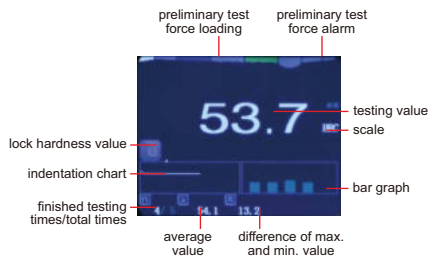

software CD
(included)

- Tolerance testing
- Set testing times (2~10) to have average value and the difference of max. and min. value
- Convert to other Rockwell scales, HV or HB
- Memory of 500 testing values for browsing and output
- Testing value can be sent to wireless printer automatically
- Calibration function compensates the testing value for high accuracy
- The hardness value of soft materials like plastic is not stable, the lock function can obtain the value automatically
- Display unit is automatic power off
- According to ISO 6508

SPECIFICATION

Hardness scale	HRA, HRB, HRC, HRD, HRF, HRG (with standard indenters) HRE, HRH, HRK (with optional indenter)
Preliminary test force	98N
Test force	588N, 980N, 1471N
Stage elevation	manual
Load control	automatic (load/dwell/unload)
Load dwell time	1~99 second
Resolution	0.1HR
Output	wireless and USB
Memory	500
Max. workpiece height	170mm
Max. testing width	165mm (from the center of indenter to the wall of main body)
Power supply of the display unit	built-in rechargeable battery
Power supply	220V, 50/60Hz
Dimension	520×160×700mm
Weight	60kg



Ø60mm flat anvil (included)



Ø150mm flat anvil (included)



wireless printer (optional)



small V-type anvil (optional)
for cylinders with diameter
Ø2-4mm



V-type anvil (included)
for cylinders with
diameter Ø4-60mm



desk (optional)

STANDARD DELIVERY

Main unit	1 pc
Ø60mm flat anvil	1 pc
Ø150mm flat anvil	1 pc
V-type anvil	1 pc
Diamond indenter	1 pc
Ø1.5875mm carbide ball indenter	1 pc
Hardness test block HRB88-95	1 pc
Hardness test block HRC60-65	1 pc
Hardness test block HRC20-30	1 pc
Anti-dust cover	1 pc
Software and USB cable	1 pc
AC/DC adapter	1 pc

OPTIONAL ACCESSORY

Wireless printer	ISH-DS-PRINTER
Ø3.175mm carbide ball indenter	ISH-EHK-INDENTER
Hardness test block HRB88-100	HDT-B-HRB
Hardness test block HRC60-70	HDT-B-HRC3
Hardness test block HRC20-30	HDT-B-HRC1
Small V-type anvil	ISH-SMALLANVIL
Desk	HDT-DESK

MANUAL ROCKWELL HARDNESS TESTER CODE ISH-R150

SPECIFICATION

Hardness scale	HRA, HRB, HRC, HRD, HRF, HRG
Preliminary test force	98N
Test force	588N, 980N, 1471N
Display	analogue
Stage elevation	manual
Load control	manual
Min. reading	0.5HR
Max. workpiece height	170mm
Max. testing width	165mm (from the center of indenter to the wall of main body)
Dimension	520×160×700mm
Weight	60kg

STANDARD DELIVERY

Main unit	1 pc
Ø60mm flat anvil	1 pc
Ø150mm flat anvil	1 pc
V-type anvil	1 pc
Diamond indenter	1 pc
Ø1.5875mm carbide ball indenter	1 pc
Hardness test block HRB88~95	1 pc
Hardness test block HRC60~65	1 pc
Hardness test block HRC20~30	1 pc
Anti-dust cover	1 pc



desk (optional)



Ø60mm flat anvil (included)



Ø150mm flat anvil (included)



V-type anvil (included) for cylinders with diameter Ø4~60mm



small V-type anvil (optional) for cylinders with diameter Ø2~4mm

■ According to ISO 6508

OPTIONAL ACCESSORY

Hardness test block HRB88~100	HDT-B-HRB
Hardness test block HRC60~70	HDT-B-HRC3
Hardness test block HRC20~30	HDT-B-HRC1
Small V-type anvil	ISH-SMALLANVIL
Desk	HDT-DESK

MOTORIZED ROCKWELL HARDNESS TESTER (BASIC TYPE) CODE HDT-RA151

SPECIFICATION

Hardness scale	HRA, HRB, HRC, HRD, HRF, HRG
Preliminary test force	98N
Test force	588N, 980N, 1471N
Display	analogue
Stage elevation	manual
Load control	automatic (load/dwell/unload)
Load dwell time	1~60 second
Min. reading	0.5HR
Max. workpiece height	170mm
Max. testing width	165mm (from the center of indenter to the wall of main body)
Power supply	220V, 50/60Hz
Dimension	520×225×640mm
Weight	65kg

STANDARD DELIVERY

Main unit	1 pc
Ø58mm flat anvil	1 pc
Ø150mm flat anvil	1 pc
V-type anvil	1 pc
Diamond indenter	1 pc
Ø1.5875mm steel ball indenter	1 pc
Level	1 pc
Hardness test block HRA80~88	1 pc
Hardness test block HRB85~95	1 pc
Hardness test block HRC20~30	1 pc
Hardness test block HRC35~55	1 pc
Hardness test block HRC60~70	1 pc
Anti-dust cover	1 pc



level (included)



Ø150mm flat anvil (included)



Ø58mm flat anvil (included)



V-type anvil (included) for cylinders with diameter Ø4~60mm



small V-type anvil (optional) for cylinders with diameter Ø2~4mm

■ According to ISO 6508

OPTIONAL ACCESSORY

Hardness test block HRA80~84	HDT-B-HRA
Hardness test block HRB88~100	HDT-B-HRB
Hardness test block HRC20~30	HDT-B-HRC1
Hardness test block HRC35~55	HDT-B-HRC2
Hardness test block HRC60~70	HDT-B-HRC3
Small V-type anvil	ISH-SMALLANVIL
Desk	HDT-DESK



desk (optional)

MANUAL ROCKWELL HARDNESS TESTER (BASIC TYPE) CODE HDT-RW160

**INSPECTION
CERTIFICATE**



desk (optional)

- According to ISO 6508

OPTIONAL ACCESSORY

Hardness test block HRA80~84	HDT-B-HRA
Hardness test block HRB88~100	HDT-B-HRB
Hardness test block HRC20~30	HDT-B-HRC1
Hardness test block HRC35~55	HDT-B-HRC2
Hardness test block HRC60~70	HDT-B-HRC3
Small V-type anvil	ISH-SMALLANVIL
Desk	HDT-DESK



level (included)



Ø58mm flat anvil (included)



small V-type anvil (optional) for cylinders with diameter Ø2~4mm



Ø150mm flat anvil (included)



V-type anvil (included) for cylinders with diameter Ø4~60mm

SPECIFICATION

Hardness scale	HRA, HRB, HRC, HRD, HRF, HRG
Preliminary test force	98N (10kg)
Test force	588N (60kg), 980N (100kg), 1471N (150kg)
Display	analogue
Stage elevation	manual
Load control	manual
Min. reading	0.5HR
Max. workpiece height	170mm
Max. testing width	135mm (from the center of indenter to the wall of main body)
Dimension	466×238×630mm
Weight	70kg

STANDARD DELIVERY

Main unit	1 pc
Ø58mm flat anvil	1 pc
Ø150mm flat anvil	1 pc
V-type anvil	1 pc
Diamond indenter	1 pc
Ø1.5875mm steel ball indenter	1 pc
Ø1.5875mm steel ball	5 pcs
Level	1 pc
Hardness test block HRA80~88	1 pc
Hardness test block HRB85~95	1 pc
Hardness test block HRC20~30	1 pc
Hardness test block HRC35~55	1 pc
Hardness test block HRC60~70	1 pc
Anti-dust cover	1 pc

DIGITAL VICKERS HARDNESS TESTER CODE HDT-VD50A



**FORCE LOADING BY ELECTRIC
MOTOR (WITHOUT WEIGHTS)**

**INSPECTION
CERTIFICATE**

- LCD touch screen, easy operation
- Insert USB flash disk, save the test results as Excel
- Converted to HRA, HRB, HRC, HRD, HRF, HV, HK, HBW, HR15N, HR30N, HR45N, HR15T, HR30T, HR45T
- Force loading by electric motor, without weights
- According to ISO 6507

SPECIFICATION

Test force	0.5, 1, 2, 2.5, 3, 5, 10, 15, 20, 30, 40, 50kgf
Range	8~2900HV
Load control	automatic (load/dwell/unload)
Load dwell time	1~99 second
Eyepiece	10X
Objective	10X, 20X
Total magnification	100X, 200X
Length measurement resolution	0.01µm
Data output	USB flash disk
Max. workpiece height	180mm
Max. testing width	160mm (from the center of indenter to the wall of main body)
Power supply	220V, 50/60Hz
Dimension	580x190x700mm
Weight	55kg

OPTIONAL ACCESSORY

Hardness test block 400~500HV10	HDT-B-HV10D
Hardness test block 400~500HV30	HDT-B-HV30D
Measuring system	HDT-VS530

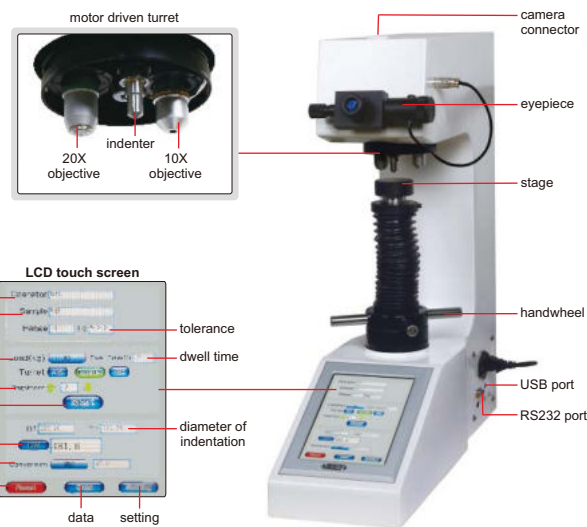

STANDARD DELIVERY

Main unit	1 pc
10X, 20X objective	1 pc of each
Vickers indenter	1 pc
Ø58mm flat anvil	1 pc
Ø150mm flat anvil	1 pc
V-type anvil	1 pc
Hardness test block 400~500HV10	1 pc
Hardness test block 400~500HV30	1 pc
USB flash disk	1 pc
Level	1 pc
Touch pen	1 pc
Anti-dust cover	1 pc



level (included)



Ø150mm flat anvil (included)



Ø58mm flat anvil (included)



V-type anvil (included)

DIGITAL MICRO-VICKERS HARDNESS TESTERS



HDT-MV290

- Measure hardness of thin or small workpieces
- Converted to HRA, HRB, HRC, HRD, HRF, HV, HK, HBW, HR15N, HR30N, HR45N, HR15T, HR30T, HR45T
- Motor driven turret to switch between indenter and objective lens automatically
- Calibrated according to standard hardness blocks or length scales
- Test result can be sent to Word or Excel
- According to ISO 6507

SPECIFICATION

Code	HDT-MV290	HDT-MV290S
		Manual switch of test force
Test force	0.098N (10gf), 0.245N (25gf), 0.49N (50gf), 0.98N (100gf), 1.96N (200gf), 2.94N (300gf), 4.9N (500gf), 9.8N (1kgf)	
Vickers scales	HV0.01, HV0.025, HV0.05, HV0.1, HV0.2, HV0.3, HV0.5, Hv1	
Range	8HV~2900HV	
Length measurement resolution	0.01µm	
Objective/indenter switch	motor driven turret	
Stage lifting	manual	
Load control	automatic (load/dwell/unload)	
Load dwell time	1~99 second	
Objective	10X, 40X	
Eyepiece	10X	
Total magnification	100X (for measurement or observation), 400X (for measurement)	
Max. workpiece height	100mm	
Max. testing width	130mm (from the center of indenter to the wall of main body)	
X-Y stage	dimensions: 100×100mm, travel range: 25×25mm	
Data output	built-in printer, Rs232	
Power supply	220V, 50/60Hz	
Dimension	540×260×650mm	
Weight	50kg	

STANDARD DELIVERY

Main unit	1 pc
10X, 40X objective	1 pc of each
Micro Vickers indenter	1 pc
Hardness test block 400~500HV0.2	1 pc
Hardness test block 700~750HV1	1 pc
Level	1 pc
Touch pen	1 pc
Slice holder	1 pc
Vice	1 pc
Cylinder holder	1 pc
Anti-dust cover	1 pc

OPTIONAL ACCESSORY

Hardness test block 400~500HV0.2	HDT-B-HV02C
Hardness test block 700~750HV1	HDT-B-HV1F
Measuring system	HDT-VS530

MOTORIZED DIGITAL BRINELL HARDNESS TESTER

**AUTOMATIC TESTING,
AUTOMATIC TEST FORCE LOADING**

**FORCE LOADING BY ELECTRIC
MOTOR (WITHOUT WEIGHTS)**

**INSIZE
CERTIFICATE**

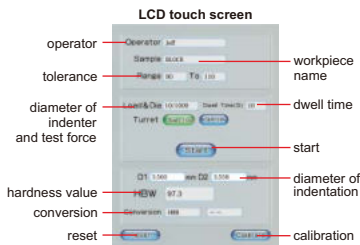

ISHB-D300

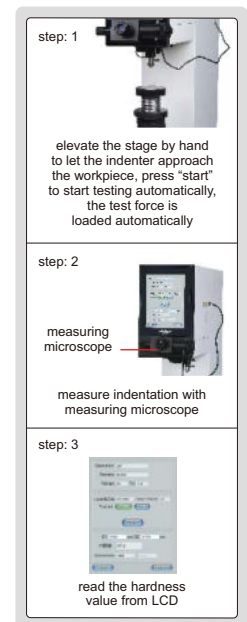

- Automatic testing, automatic test force loading
- LCD touch screen, easy operation
- Measure indentation by measuring microscope then read the hardness value from LCD
- Tolerance testing
- Insert USB flash disk, save the test results as Excel
- Converted to HRA, HRB, HRC, HRD, HRF, HV, HB, HR15N, HR30N, HR45N, HR15T, HR30T, HR45T
- Force loading by electric motor, without weights
- According to ISO 6506



SPECIFICATION

Code	ISHB-D300	
Turret rotation	automatic	
Range	8~650HBW	
Reading mode	directly read from LCD	
Test force	62.5, 100, 125, 187.5, 250, 500, 750, 1000, 1500, 3000kgf	
Max. workpiece height	200mm	
Max. testing width	155mm (from the center of indenter to the wall of main body)	
Stage elevation	manual	
Load control	automatic (load/dwell/unload)	
Load dwell time	5~60 second	
Measuring microscope	magnification	20X
	resolution	0.625µm
Power supply	220V, 50/60Hz	
Dimension	550x210x750mm	
Weight	110kg	

STANDARD DELIVERY

Main unit	1 pc
Ø80mm flat anvil	1 pc
Ø200mm flat anvil	1 pc
V-type anvil	1 pc
Ø2.5mm carbide ball indenter	1 pc
Ø5mm carbide ball indenter	1 pc
Ø10mm carbide ball indenter	1 pc
Hardness test block 150~250HBW2.5/187.5	1 pc
Hardness test block 75~125HBW10/1000	1 pc
Hardness test block 175~250HBW10/3000	1 pc
USB flash disk (8G)	1 pc
Touch pen	1 pc
Anti-dust cover	1 pc

OPTIONAL ACCESSORY

Hardness test block 200~300HBW2.5/187.5	HDT-B-HB25A2
Hardness test block 90~200HBW10/1000	HDT-B-HB10C1
Hardness test block 200~300HBW10/3000	HDT-B-HB10A2
Brinell indentation measuring system	ISHB-MSA
Desk	HDT-DESK

DIGITAL BRINELL/ROCKWELL/VICKERS HARDNESS TESTER CODE HDT-BRV130



FORCE LOADING BY ELECTRIC
MOTOR (WITHOUT WEIGHTS)



- According to ISO 6506, ISO 6507, ISO 6508
- Force loading by electric motor (without weights)

SPECIFICATION

Brinell test load	49N (5kgf), 98N (10kgf), 153N (15.625kgf), 294N (30kgf), 306N (31.25kgf), 613N (62.5kgf), 980N (100kgf), 1226N (125kgf), 1839N (187.5kgf)
Brinell scales	HBW1/5, HBW2.5/62.5, HBW1/10, HBW2.5/15.625, HBW1/30, HBW2.5/31.25, HBW2.5/62.5, HBW10/100, HBW5/125, HBW2.5/187.5
Brinell resolution	0.1HBW
Rockwell test load	98N (10kgf) preload 588 (60kgf), 980 (100kgf), 1471N (150kgf) total load
Rockwell scales	HRA, HRB, HRC, HRD, HRE, HRF, HRG, HRH, HRK, HRL, HRM, HRP, HRR, HRS, HRV
Rockwell resolution	0.1HR
Vickers test load	49N (5kgf), 98N (10kgf), 196N (20kgf), 294N (30kgf), 392N (40kgf), 490N (50kgf), 588N (60kgf), 784N (80kgf), 980N (100kgf), 1176N (120kgf)
Vickers scales	HV5, HV10, HV20, HV30, HV40, HV50, HV60, HV80, HV100, HV120
Vickers resolution	0.1HV
Objective	2.5X/5X
Magnification of microscope	Brinell: 37.5X, Vickers: 75X
Hardness test range	Brinell: 8~650HBW, Rockwell: 20~100HR, Vickers: 8~2900HV
Max. workpiece height	Rockwell: 220mm, Brinell and Vickers: 150mm
Max. testing width	200mm (from the center of indenter to the wall of main body)
Data output	USB flash disk
Power supply	220V, 50/60Hz
Dimension	560×350×800mm
Weight	70kg



STANDARD DELIVERY

Main unit	1 pc
Vickers diamond indenter	1 pc
Rockwell diamond indenter	1 pc
Ø1.5875mm Rockwell indenter	1 pc
Ø2.5mm Brinell indenter	1 pc
Ø5mm Brinell indenter	1 pc
Ø60mm flat anvil for Rockwell	1 pc
Ø150mm flat anvil for Rockwell	1 pc
V-type anvil for Rockwell	1 pc
Ø60mm flat anvil for Vickers and Brinell	1 pc
Hardness test block HRB88-95	1 pc
Hardness test block HRC60-65	1 pc
Hardness test block HRC20-30	1 pc
Hardness test block 400-500HV30	1 pc
Hardness test block 180-300HBW2.5/187.5	1 pc
Level	1 pc
USB flash disk	1 pc
Touch pen	1 pc
Anti-dust cover	1 pc



OPTIONAL ACCESSORY

Hardness test block HRB88~100	HDT-B-HRB
Hardness test block HRC60~70	HDT-B-HRC3
Hardness test block HRC20~30	HDT-B-HRC1
Hardness test block 400-500HV30	HDT-B-HV30D
Hardness test block 200-300HBW2.5/187.5	HDT-B-HB25A2
Small V-type anvil for Rockwell	ISH-SMALLANVIL
Desk	HDT-DESK

BRINELL/ROCKWELL/VICKERS HARDNESS TESTER CODE ISH-BRV

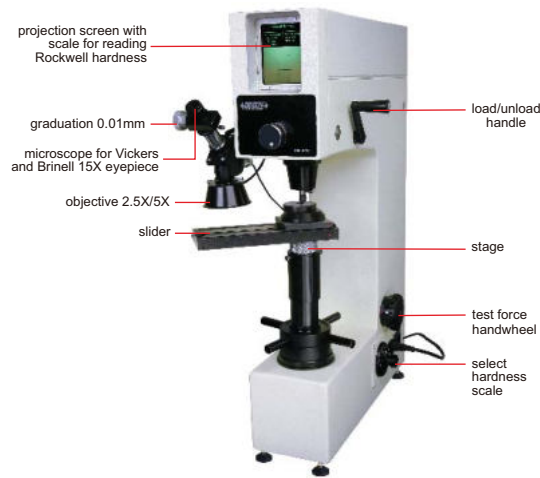

- According to ISO 6506, ISO 6507, ISO 6508



Ø60mm flat anvil for Rockwell (included)



Ø150mm flat anvil for Rockwell (included)



Ø60mm flat anvil for Vickers and Brinell (included)



V-type anvil for Rockwell (included), for cylinders with diameter Ø4-60mm



V-type anvil for Vickers and Brinell (included)



small V-type anvil for Rockwell (optional), for cylinders with diameter Ø2-4mm



desk (optional)

SPECIFICATION

Rockwell test load	98N preload, 588, 980, 1471N total load
Min. Rockwell reading	0.5HR
Brinell test load	306, 613, 1839N
Vickers test load	294N
Stage elevation	manual
Load control	manual
Magnification of microscope	37.5X/75X
Max. workpiece height	180mm
Max. testing width	200mm (from the center of indenter to the wall of main body)
Power supply	220V, 50/60Hz
Dimension	546×300×767mm
Weight	90kg

STANDARD DELIVERY

Main unit	1 pc
Ø1.5875mm carbide ball indenter	1 pc
Diamond Rockwell indenter	1 pc
Ø5mm Brinell indenter	1 pc
Ø2.5mm Brinell indenter	1 pc
Vickers indenter	1 pc
Ø60mm flat anvil for Rockwell	1 pc
Ø150mm flat anvil for Rockwell	1 pc
V-type anvil for Rockwell	1 pc
Ø60mm flat anvil for Vickers and Brinell	1 pc
V-type anvil for Vickers and Brinell	1 pc
Hardness test block HRB88-95	1 pc
Hardness test block HRC60-65	1 pc
Hardness test block HRC20-30	1 pc
Hardness test block 400-500HV30	1 pc
Hardness test block 180-300HBW2.5/187.5	1 pc
Anti-dust cover	1 pc

OPTIONAL ACCESSORY

Hardness test block HRB88-100	HDT-B-HRB
Hardness test block HRC60-70	HDT-B-HRC3
Hardness test block HRC20-30	HDT-B-HRC1
Hardness test block 400-500HV30	HDT-B-HV30D
Hardness test block 200-3000HBW2.5/187.5	HDT-B-HB25A2
Small V-type anvil for Rockwell	ISH-SMALLANVIL
Desk	HDT-DESK

VICKERS HARDNESS MEASURING SYSTEM CODE HDT-VS530

measure the indentation sizes automatically or manually, and hardness tester can be controlled by software



C-mount



software CD
(included)

- Suitable for digital Vickers hardness tester HDT-VD series and HDT-MV series
- Connected to computer USB port
- Measure the indentation sizes automatically or manually
- Multiple measurements to have average value, max. value, min. value and variance
- Convert to HRA, HRB, HRC, HRD, HRF, HV, HK, HBW, HR15N, HR30N, HR45N, HR15T, HR30T, HR45T
- Hardness tester can be controlled by software
- Measurement result can be sent to Word, Excel or CSV

measuring software (included)

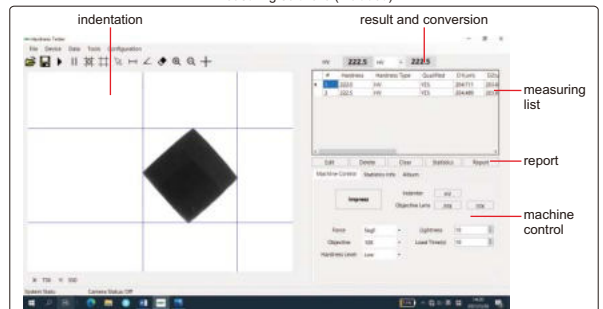

indentation

result and conversion

measuring list

report

machine control

SPECIFICATION

Sensor	1/2.5" CMOS
Pixel	5M (resolution 2592×1944)
Hardness measurement resolution	0.1HV
Length measurement resolution	0.001µm
Test force	1, 2, 2.5, 3, 5, 10, 15, 20, 30, 40, 50kgf
Dimension	30×30×40mm
Weight	50g

STANDARD DELIVERY

Main unit	1 pc
Software and USB cable	1 pc
Rs232 cable	1 pc
USB dongle	1 pc
Camera adapter	1 set

camera adapter (included)



PORTABLE LEEB HARDNESS TESTER CODE ISH-PHB



VIDEO

INSPECTION
CERTIFICATE

- Based on Leeb (HLD), converted to Vickers (HV), Brinell (HB), Rockwell (HRC and HRB), Shore (HS) and tensile strength (MPa)
- Memory of 99 measurement values for browsing
- Set measurement times (1~9) to have average value
- Connected with printer via bluetooth
- Automatic power off
- According to ASTM A 956

SPECIFICATION

Min. reading	1HLD, 1HV, 1HB, 0.1HRC, 0.1HRB, 1HS, 1MPa	
Accuracy	±6HLD (when HLD=800)	
Display	Leeb (HLD), converted hardness, material, impact direction, test times, average value, date	
Output	bluetooth	
Applicable workpiece	minimum weight	5kg
		2kg (on solid support)
	minimum thickness: 5mm	0.1kg(coupled on plate)
		minimum radius of curved surface: 30mm
	maximum roughness (Ra): 1.6µm	
Power supply	3×AAA batteries	
Dimension	150×84×28mm	
Weight	200g	



hardness test block D
(included)



small support ring
(included)



wireless printer
(optional)

STANDARD DELIVERY

Main unit	1 pc
Impact device D	1 pc
Hardness test block D	1 pc
Small support ring	1 pc
Cleaning brush	1 pc

OPTIONAL ACCESSORY

Wireless printer	ISH-DS-PRINTER
Couplant	ISH-COULPLANT
Support rings	refer to details
Hardness test block D	HDT-B-HLD3

PORTABLE LEEB HARDNESS TESTERS (BASIC TYPE)

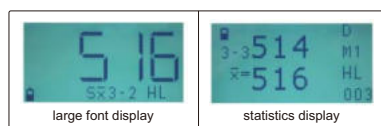

- Can change probes
- Dual-coil probe for high accuracy
- Universal testing angle, no need to set impact direction
- Based on Leeb (HLD), converted to Vickers (HV), Brinell (HB), Rockwell (HRC, HRA and HRB), Shore (HS) and tensile strength (SGM)
- Dual value display, shows both Leeb and converted hardness
- Large LCD display with backlight
- Can choose large font display and statistics display
- Automatically calculate maximum, minimum and average value
- Save 300 data
- Operation temperature: -10°C~45°C
- According to ASTM A956, DIN 50156, GB/T 17394



HDT-LP200



small support ring (included)



hardness test block D (included)



wireless printer (included in HDT-LP200B)

SPECIFICATION

Code	HDT-LP200	HDT-LP200B
Printer	not included	included
Output	–	bluetooth
Resolution	1HLD/1HV/1HB/0.1HRC/0.1HRB/0.1HRA/0.1HS/1SGM	
Accuracy	±6HLD (when HLD=800)	
Measuring range	HL 100-960/HRC 0.9-79.2/HRB 1-140/HB 1-1878/HV 1-1698/HS 0.5-1370/HRA 1-88.5/SGM (rm) 1-6599N/mm ²	
Power supply	2xAA battery	
Dimension	127×67×30mm	
Weight	240g	

STANDARD DELIVERY

Main unit	1 pc
Hardness test block D	1 pc
Small support ring	1 pc
Cleaning brush	1 pc
Impact device D	1 pc
Printer (included in HDT-LP200B)	1 pc

OPTIONAL ACCESSORY

Impact device DC	HDT-LP200-DC
Impact device C	HDT-LP200-C
Impact device D+15	HDT-LP200-D15
Impact device DL	HDT-LP200-DL
Impact device E*	HDT-LP200-E
Impact device G	HDT-LP200-G
Hardness test block D**	HDT-B-HLD3
Hardness test block G**	HDT-B-HLG2
Support rings	refer to details

*Impact device E (HDT-LP200-E) must be purchased together with the main unit.

**Hardness test block G (HDT-B-HLG2) is for impact device G (HDT-LP200-G).
Hardness test block D (HDT-B-HLD3) is for all others impact devices.

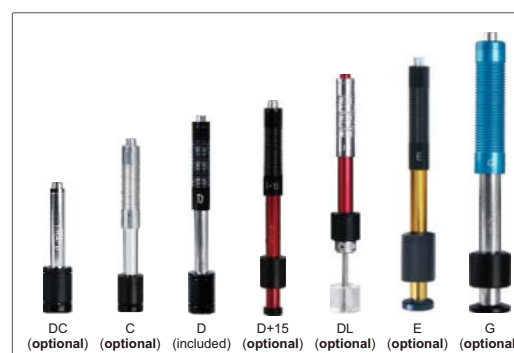

APPLICABLE WORKPIECE

Impact device	DC	C	D	D+15	DL	E	G
Application	inner wall of small space	small or thin workpiece, coating layer	general use	deep groove	narrow slot or small hole	very hard material	casting or forging workpiece
Maximum roughness of workpiece (Ra)	2µm	0.4µm	2µm	2µm	2µm	2µm	7µm
Minimum weight of workpiece	direct measurement	5kg	1.5kg	5kg	5kg	5kg	15kg
	on solid support	2kg	0.5kg	2kg	2kg	2kg	5kg
	coupled on plate	0.05kg	0.02kg	0.05kg	0.1kg	0.05kg	0.5kg
Minimum thickness of workpiece	3mm	1mm	3mm	3mm	3mm	3mm	10mm

PORTABLE LEEB HARDNESS TESTER (HIGH ACCURACY) CODE HDT-L410

DATA
OUTPUT

HIGH
ACCURACY

DL PROBE IS
OPTIONAL

INSPECTION
CERTIFICATE

- Metal housing
- HD TFT 320×320 display
- Impact device D
- Based on Leeb (HLD), converted to Vickers (HV), Brinell (HB), Rockwell (HRC, HRA and HRB), Shore (HS) and tensile strength (SGM)
- Four display modes
- Automatic direction correction
- Tolerance testing
- Automatic power off, automatic calculation of statistics
- Dual value display, shows both Leeb and other conversion values
- 31 files can be saved, each containing 100 measurement data
- Connected to PC software via USB or Bluetooth 2.0
- Connected with printer via Bluetooth
- Operation temperature: -20°C~70°C
- According to ASTM A956, DIN 50156, GB/T 17394



DL probe can be installed (optional)



histogram display

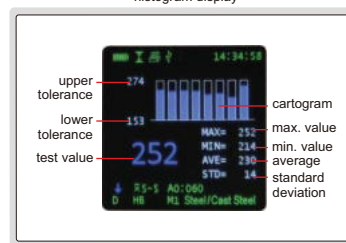

dynamic ring display

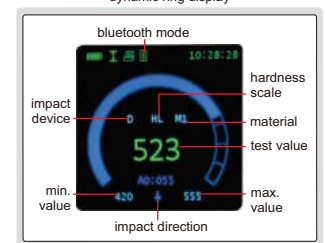

can choose large font display

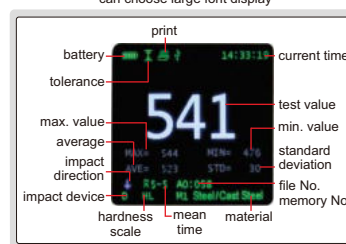

statistic display

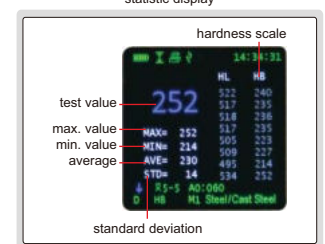

software (included), upload the memory to PC, print and send to EXCEL

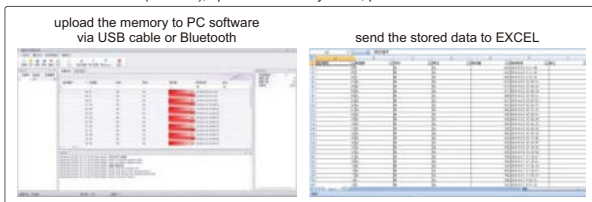

SPECIFICATION

Resolution	1HLD, 1HV, 1HB, 0.1HRC, 0.1HRB, 0.1HRA, 0.1HS, 1SGM	
Accuracy	±4HLD (when HLD=800)	
Output	USB and bluetooth	
Applicable workpiece	minimum weight	5kg (direct measurement)
		2kg (on solid support)
		0.05kg (coupled on plate)
	minimum thickness: 5mm	
minimum radius of curved surface: 30mm		
maximum roughness (Ra): 2µm		
Power supply	built-in 3.7V rechargeable battery	
Dimension	148×44×22mm	
Weight	115g	

STANDARD DELIVERY

Main unit	1 pc
Hardness test block D	1 pc
Small support ring	1 pc
Cleaning brush	1 pc
AC/DC adapter	1 pc
Software disc and USB cable	1 pc

OPTIONAL ACCESSORY

Printer	HDT-L410-PRINTER
Support rings	ISH-PH-SP9
Hardness test block D	HDT-B-HLD3
DL probe	HDT-L410-DL

PORTABLE LEEB HARDNESS TESTER (BASIC TYPE) CODE HDT-L411



software CD
(included)



small support ring
(included)



hardness test
block D (included)



- Impact device D
- Universal testing angle, no need to set impact direction
- Dual-coil probe, high accuracy
- Based on Leeb (HLD), converted to Vickers (HV), Brinell (HB), Rockwell (HRC, HRA and HRB), Shore (HS) and tensile strength (SGM)
- Dual value display, shows both Leeb and converted hardness
- High contrast digital LCD display
- Can choose large font display
- Automatically calculate maximum, minimum, average value
- Connected to PC via USB
- Save 999 data
- Operation temperature: -20°C~45°C
- According to ASTM A956, DIN 50156, GB/T 17394

SPECIFICATION

Resolution	1HLD, 1HV, 1HB, 0.1HRC, 0.1HRB, 0.1HRA, 0.1HS, 1SGM	
Accuracy	±6HLD (when HLD=800)	
Output	USB	
Measuring range	HL100-960, HRC1-74.7, HRB1.2-140, HB28-1027, HV45-1230, HS4-112, HRA7-88.5, SGM (rm) 118-3315N/mm ²	
Applicable workpiece	minimum weight	5kg (direct measurement)
		2kg (on solid support)
		0.05kg (coupled on plate)
	minimum thickness: 5mm	
minimum radius of curved surface: 30mm		
maximum roughness (Ra): 2µm		
Power supply	1xAAA battery	
Dimension	148×45×21mm	
Weight	105g	

can choose large font display

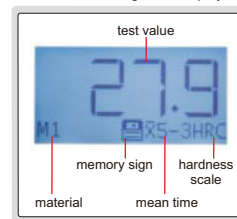

software (included), upload the memory to PC, print and send to EXCEL

upload the memory to PC software via USB cable



send the stored data to EXCEL

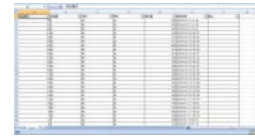

STANDARD DELIVERY

Main unit	1 pc
Hardness test block D	1 pc
Cleaning brush	1 pc
AAA battery	1 pc
Small support ring	1 pc
Software disc and USB cable	1 pc

OPTIONAL ACCESSORY

Support rings	ISH-PH-SP9
Hardness test block D	HDT-B-HLD3

ALUMINUM HARDNESS TESTER



- To measure the hardness of soft metal such as aluminum alloy, copper, brass, soft steel, etc.
- According to ASTM B647-84 (2000)

SPECIFICATION

Code	ISHW-L20
Application	for aluminum alloy general use
Thickness requirement of flat workpiece	0.6~6mm
Internal diameter requirement of tube workpiece	>Ø10mm
Wall thickness requirement of tube workpiece	0.6~6mm
Hardness range	0~20HW
Min. reading	1HW
Accuracy	±0.5HW (at 5~17HW)
Dimension	205x30x85mm
Weight	500g



ISHW-L20

STANDARD DELIVERY

Main unit	1 pc
Spare indenter	1 pc
Hardness test block	1 pc
Wrench	1 pc

BARCOL HARDNESS TESTER CODE ISHB-B300



- To measure the hardness of workpieces made of pure aluminum, aluminum alloy, fiber reinforced plastic, hard plastic, etc.
- According to ASTM B648-00, ASTM D2853-07



SPECIFICATION

Hardness range	0~100HBa (equal to 25~150HBW)
Min. reading	1HBa
Accuracy	±2HBa (at 42~52HBa) ±1HBa (at 84~88HBa)
Min. workpiece thickness	0.8mm
Dimension	142×65×90mm
Weight	500g

STANDARD DELIVERY

Main unit	1 pc
Spare indenter	2 pcs
Hardness test block	2 pcs
Wrench	1 pc

DIGITAL SHORE DUROMETERS



- According to ISO868, ISO7619, ASTM D 2240
- Average and peak (max.) mode
- Dwell time is adjustable
- Tolerance testing
- 500 memories
- Wireless connection to printer
- Handhold use or work with test stand (code ISH-DS-STANDA)
- Automatic power off

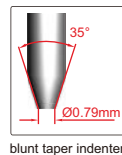

blunt taper indenter



ISH-DSA

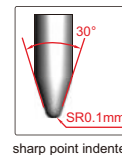

sharp point indenter



ISH-DSD

DATA
OUTPUT



software CD
(included)



calibration block
(included)



printer (optional)

SPECIFICATION

Code	ISH-DSA	ISH-DSD
Unit	Shore A	Shore D
Test material	soft plastic, soft rubber, etc.	hard plastic, hard rubber, etc.
Measuring range *	0~100HA	0~100HD
Resolution	0.1HA	0.1HD
Accuracy	±1HA	±1HD
Indenter protrusion	2.5mm	
Output	wireless and USB	
Power supply	built-in rechargeable battery	
Dimension	153x50x29mm	
Weight	170g	

STANDARD DELIVERY

Main unit	1 pc
Calibration block	1 pc
Software and USB cable	1 pc
AC/DC adapter	1 pc

OPTIONAL ACCESSORY

Printer	ISH-DS-PRINTER
Test stand	ISH-DS-STAND

- * Use ISH-DSD when measuring result is higher than 90HA
Use ISH-DSA when measuring result is lower than 20HD

TEST STAND FOR DIGITAL SHORE DUROMETERS CODE ISH-DS-STANDA

- For digital shore durometers (code ISH-DSA and ISH-DSD)
- Can perform repeatable hardness measurement due to fewer possibilities of human error or measurement variations
- Special structure for stable loading
- Weight block A is for ISH-DSA, weight block D is for ISH-DSD

SPECIFICATION

Stage diameter	Ø115mm
Max. workpiece height	45mm
Max. testing width	63mm (from test point to the column)
Dimension	Ø195×370mm
Weight	5.61kg

STANDARD DELIVERY

Test stand	1 pc
Weight block A (for ISH-DSA)	1 pc



weight block D (optional)
for ISH-DSD



OPTIONAL ACCESSORY

Weight block D (for ISH-DSD)	ISH-DS-W4
------------------------------	-----------

SHORE DUROMETERS

- According to ISO868, ISO7619, ASTM D 2240
- With peak value indicator
- Optional accessory: test stand **ISH-STAC** and **ISH-STD**



calibration block (optional)



VIDEO

SPECIFICATION

Code	ISH-SAM	ISH-SDM
Scale	Shore A	Shore D
Application	natural rubber, soft elastomer, etc.	hard elastomer, plastic, hard rubber, etc.
Measuring range *	10~90HA	20~90HD
Graduation	1HA	1HD
Indenter protrusion	2.5mm	
Dimension	115x60x25mm	
Net weight	160g	

* Use **ISH-SDM** when measuring result is higher than 90HA
Use **ISH-SAM** when measuring result is lower than 20HD

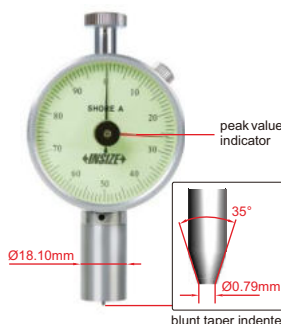

ISH-SAM

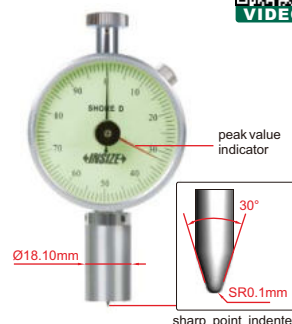

ISH-SDM

OPTIONAL ACCESSORY

Calibration block	ISH-DS-BLOCK
-------------------	--------------

TEST STAND FOR SHORE DUROMETER

- For shore durometers (code **ISH-SAM** and **ISH-SDM**)
- Perform repeatable hardness measurement due to fewer possibilities of human error or measurement variations

SPECIFICATION

Code	ISH-STAC
Applicable durometer	ISH-SAM
Stage diameter	Ø100mm
Max. workpiece height	75mm
Max. testing width	65mm (from test point to the column)
Weight block	1kg

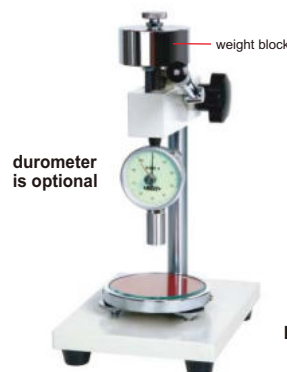

durometer is optional

ISH-STAC



VIDEO

DIGITAL FORCE GAGES

DATA OUTPUT

INSPECTION CERTIFICATE



VIDEO

- Push and pull test
- Units: lbf, ozf, N, gf, kgf
- 500 memories
- Automatic power off
- Metal case
- LCD display with backlight
- The display flips over when the bottom faces up
- Overload alarm

software CD (included)



printer (optional)



ISF-1DF100

SPECIFICATION

Code	ISF-1DF10	ISF-1DF50	ISF-1DF100	ISF-1DF500	ISF-1DF1000
Load capacity (N)	10	50	100	500	1000
Resolution (N)	0.01	0.01	0.1	0.1	1
Accuracy	±0.3% (of load capacity)				
Measuring mode	tracking, peak (max.), tolerance testing				
Power supply	built-in rechargeable battery				
Dimension	150×73×33mm				
Weight	450g				

STANDARD DELIVERY

Main unit	1 pc
AC/DC adapter	1 pc
Software and USB cable	1 pc
Push/pull accessory	6 pcs (flat push tip, V-type push tip, knife-edge push tip, point push tip, pull clamp, extension rod)

accessory (included)

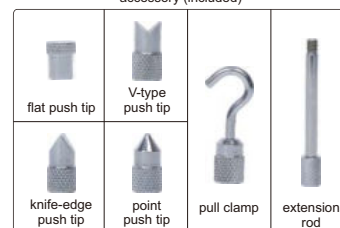

OPTIONAL ACCESSORY

Printer	ISF-DF-PRINTER
Test stand	ISF-MT1K

DIGITAL FORCE GAGES (HIGH ACCURACY)

**INSPECTION
CERTIFICATE**

**DATA
OUTPUT**



ISF-DF100A

- Push and pull test
- Peak (max.) and tracking mode
- Units: mN, N, gf, kgf, ozf, lbf
- Tolerance testing
- 1000 memories
- Automatic power off
- Metal case, touch buttons
- LCD display with backlight
- The display flips over when the bottom faces up
- Overload alarm
- Keyboard signal, can be transmitted to Excel

printer (optional)



software CD
(included)



SPECIFICATION

Code	ISF-DF50A	ISF-DF100A	ISF-DF200A	ISF-DF500A	ISF-DF1KA
Type	internal sensor				
Load capacity (N)	50	100	200	500	1000
Resolution (N)	0.005	0.01	0.05	0.05	0.1
Accuracy	±0.2% (of load capacity)				
Power supply	built-in rechargeable battery				

accessory (included)

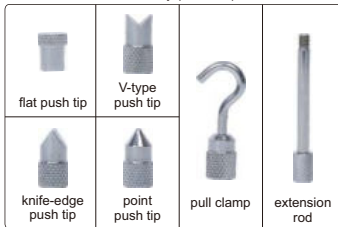

STANDARD DELIVERY

Main unit	1 pc
AC/DC adapter	1 pc
Software and USB cable	1 pc
Push/pull accessory	6 pcs (flat push tip, V-type push tip, knife-edge push tip, point push tip, pull clamp, extension rod)

OPTIONAL ACCESSORY

Printer	ISF-DF-PRINTER
Test stand	ISF-MT1K

TEST STAND FOR DIGITAL FORCE GAGE CODE ISF-MT1K

- For digital force gages (code ISF-1DF□□ and ISF-DF□□)
- To be used in vertical and horizontal orientation

SPECIFICATION

Load capacity	1000N
Travel	200mm (3mm vertical movement per revolution of handwheel)
Dimension	196x250x446mm
Weight	13kg

OPTIONAL ACCESSORY

Digital scale (range: 200mm, resolution: 0.01mm/0.0005")	ISF-MT1K-SCALE
--	----------------

force gage
is optional



horizontal orientation test



digital scale (optional)



FORCE GAGES



- Push and pull test
- Peak (max.) or tracking mode

SPECIFICATION

Code	ISF-F10	ISF-F20	ISF-F30	ISF-F50	ISF-F100	ISF-F200	ISF-F300	ISF-F500	
Capacity	N	10	20	30	50	100	200	300	500
	kgf	1	2	3	5	10	20	30	50
Graduation	N	0.05	0.1	0.2	0.25	0.5	1	2	2.5
Accuracy	±1% (of load capacity)								

STANDARD DELIVERY

Main unit	1 pc
Push tip	4 pcs (flat, V type, knife-edge, point)
Pull clamp	1 pc
Extension rod	1 pc

OPTIONAL ACCESSORY

Test stand	ISF-MT500
------------	-----------



ISF-F500

accessory (included)

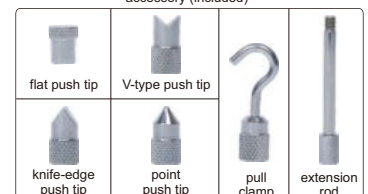

TEST STAND FOR FORCE GAGE CODE ISF-MT500

- For force gages (code ISF-F□□□)
- To be used in vertical and horizontal orientation



horizontal orientation test

SPECIFICATION

Load capacity	500N
Travel	150mm (3mm vertical movement per revolution of handwheel)
Dimension	160×240×460mm
Weight	12kg



force gage is optional



VIDEO

MANUAL HORIZONTAL TEST STAND FOR FORCE GAGES

ATTENTION: ONLY
FOR PULL TEST



VIDEO

force gage is optional



- For pull test with force gages

SPECIFICATION

Code	ISF-H20D
Apply to	digital force gages (code ISF-1DF□□□ and ISF-DF□□□)
Load capacity	500N
Travel	60mm
Dimension	450×185×170mm
Weight	9kg

MANUAL STRIPPING FORCE TEST STAND



VIDEO

force gage is optional



stripping angle 45°

- For stripping force test with force gages

SPECIFICATION

Code	ISF-P30D
Apply to	digital force gages (code ISF-1DF□□□ and ISF-DF□□□)
Load capacity	500N
Horizontal travel	170mm
Dimension	420×215×480mm
Weight	22kg

MOTORIZED VERTICAL TEST STAND CODE ISF-RV61

- For digital force gages (code ISF-1DF□□□ and ISF-DF□□□)
- Push and pull test
- Automatic and manual test
- Programmable automatic operation (automatic cycle)
- Four operation modes: displacement cycle (D cycle), force cycle (F cycle), demo (teaching & playback) mode and positioning mode
- Alarm indications: stroke overrange alarm, force overrange alarm, motor block alarm

SPECIFICATION

Load capacity	650N (250lbf, 65kg)
Max. travel	220mm
Resolution of displacement	0.01mm
Accuracy of displacement	±0.3mm
Range of adjustable speed	30~720mm/min
Resolution of speed	1mm/min
Accuracy of speed	±2%
Data output	USB, RS232
Work temperature and relative humidity	10~40°C, 10%~80%RH
Power supply	100~230V
Dimension	340×180×630mm
Weight	15.5kg

digital force gage is optional



VIDEO

STANDARD DELIVERY

Test stand	1 pc
AC/DC adapter	1 pc
MD8 cable (for force gages)	1 pc
Software and USB cable	1 pc

MOTORIZED HORIZONTAL TEST STAND CODE ISF-RH62



- For digital force gages (code **ISF-1DF** and **ISF-DF**)
- Push and pull test
- Automatic and manual test
- Programmable automatic operation (automatic cycle)
- Four operation modes: displacement cycle (D cycle), force cycle (F cycle), demo (teaching & playback) mode and positioning mode
- Alarm indications: stroke overrange alarm, force overrange alarm, motor block alarm

digital force gage
is optional



SPECIFICATION

Load capacity	650N (250lbf, 65kg)
Max. travel	220mm
Resolution of displacement	0.01mm
Accuracy of displacement	±0.3mm
Range of adjustable speed	30~720mm/min
Resolution of speed	1mm/min
Accuracy of speed	±2%
Data output	USB, RS232
Work temperature and relative humidity	10~40°C, 10%~80%RH
Power supply	100~230V
Dimension	671×120×278mm
Weight	13kg

STANDARD DELIVERY

Test stand	1 pc
AC/DC adapter	1 pc
MD8 cable (for force gages)	1 pc
Software and USB cable	1 pc

DIGITAL SPRING TESTERS

DATA
OUTPUT



- Peak hold and automatic release function
- Set upper and lower limits, red and green indicator and buzzer alarm
- Automatic conversion of three units: N, kgf, lbf
- Built in printer
- Automatic power off



ISF-S500

SPECIFICATION

Code	ISF-S50	ISF-S100	ISF-S200	ISF-S300	ISF-S500
Maximum load	50N	100N	200N	300N	500N
Resolution	0.01N	0.02N	0.05N	0.1N	0.1N
Range of digital scale	95mm				
Resolution of digital scale	0.01mm				
Disk diameter	Ø49mm				
Maximum free length of spring	95mm				
Measuring range of force	5%~100% (maximum load)				
Accuracy of force	±1% (maximum load)				
Data output	RS232				
Power supply	220V, 50/60Hz				
Dimension	300×235×620mm				
Weight	17.3kg	19.1kg	19.1kg	19.1kg	20.8kg

STANDARD DELIVERY

Main unit	1 pc
-----------	------

DIAL TENSION GAGES



- Clockwise and counter-clockwise use
- For electronic and precision mechanical industry, such as test the contact pressure of relay, adjust the tension or compression of spring

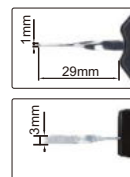

ISF-TG3

SPECIFICATION (Unit: N)

Code	ISF-TGD1	ISF-TGD3	ISF-TGD5	ISF-TG1	ISF-TG1D5	ISF-TG3	ISF-TG5
Range (N)	0.01~0.1	0.03~0.3	0.05~0.5	0.1~1	0.15~1.5	0.3~3	0.5~5
Graduation (N)	0.002	0.005	0.01	0.02	0.025	0.05	0.1
Accuracy	±2% (full scale)						
Dimension (L×W×H)	90×47×19mm						
Weight	60g						

SPECIFICATION (Unit: gf)

Code	ISF-TG10	ISF-TG30	ISF-TG50	ISF-TG100	ISF-TG150	ISF-TG300	ISF-TG500
Range (gf)	1~10	3~30	5~50	10~100	15~150	30~300	50~500
Graduation (gf)	0.2	0.5	1	2	2.5	5	10
Accuracy	±2% (full scale)						
Dimension (L×W×H)	90×47×19mm						
Weight	60g						

DIGITAL TORQUE TESTERS

ATTENTION: NOT SUITABLE FOR ELECTRIC WRENCHES, IMPACT WRENCHES OR PNEUMATIC WRENCHES

- Test torque wrenches, torque screwdrivers and other torque tools
- Clockwise operation
- Peak, track and first peak working modes
- Tolerance testing
- LED indicator for target torque alarm:
 - Green LED light on when the value is within tolerance;
 - Red LED light on when the value is above the high tolerance
- Power off automatically in 2 minutes without any operations



IST-04TT350 type A



IST-04TT815 type B

SPECIFICATION

Code	IST-04TT5	IST-04TT28	IST-04TT68	IST-04TT350	IST-04TT815	IST-04TT1000
Type	A				B	
Range	0.5~5N.m	2.8~28N.m	6.8~68N.m	35~350N.m	81.5~815N.m	100~1000N.m
Accuracy	±1% (clockwise)					
Resolution	0.001N.m	0.01N.m	0.01N.m	0.1N.m	0.1N.m	1N.m
Unit	N.m, in.lb, ft.lb, kg.cm					N.m, ft.lb
Square socket/hex driver	1/4"	3/8"	3/8"	1/2"	27mm	27mm
Power supply	DC					
Weight	0.75kg	0.75kg	1.1kg	1.1kg	5.1kg	5.1kg



STANDARD DELIVERY

Main unit	1 pc
AC/DC adapter	1 pc

TORQUE SCREWDRIVERS

ATTENTION: CLOCKWISE OPERATION ONLY



T-bar wrench (for IST-MG250, IST-MG360, IST-MG600)



IST-MG100

SPECIFICATION

Code	IST-MG100	IST-MG250	IST-MG360	IST-MG600
Range (clockwise)	20~100cN.m	50~250cN.m	60~360cN.m	1.0~6.0N.m
Graduation	2cN.m	5cN.m	5cN.m	0.1N.m
Head	1/4" hex socket			
Accuracy	±6%			
Length	172mm			
Weight	0.26kg			

STANDARD DELIVERY

Torque screwdriver	1 pc
T-bar wrench (for IST-MG250, IST-MG360, IST-MG600)	1 pc

DIGITAL TORQUE SCREWDRIVERS



- Clockwise and counter-clockwise operation
- Unit: cN.m, in.lb, kg.cm
- Peak and track working modes
- Target torque value can be set, with audible and visible alarm:
 - Green LED light on and buzzer sounds when target torque value is 90%~100% of target torque
 - Red LED light on and buzzer sounds when target torque value is reached
- Power off automatically in 5 minutes without any operations

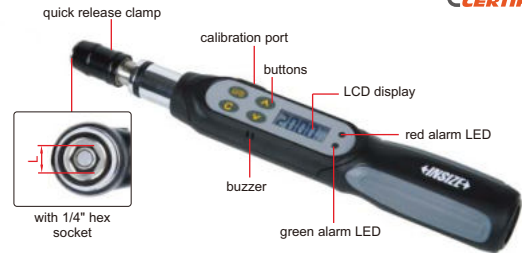

SPECIFICATION

Code	IST-SD50	IST-SD200
Range	10~50cN.m	40~200cN.m
Accuracy	clockwise	±3%
	counter-clockwise	±4%
Resolution	0.1cN.m	0.1cN.m
Size of hex socket (L)	1/4"	1/4"
Power supply	1xAAA battery	
Length	193mm	203mm
Weight	190g	200g

STANDARD DELIVERY

Torque screwdriver	1 pc
Phillips screwdriver bits	1 pc
Hex screwdriver bits	1 pc

OPTIONAL ACCESSORY

Calibration cable	IST-SD-CABLE
-------------------	--------------

IST-SD200



DIGITAL TORQUE WRENCHES

- Clockwise and counter-clockwise operation
- Unit: N.m, in.lb, ft.lb, kg.cm
- Peak and track working modes
- Target torque value can be set, with audible and visible alarm:
 - Green LED light on and buzzer sounds when torque value is 90%~100% of target torque
 - Both green and red LED light on and buzzer sounds when target torque value is reached
- Power off automatically in 5 minutes without any operations
- Non-slip grip handle
- With damp record
- With overload record (once the torque reaches 110% of the maximum range)



OPTIONAL ACCURACY:
CLOCKWISE: ±1%
COUNTER-CLOCKWISE: ±2%
ONLY FOR RANGE FOR 6~850N.m



SPECIFICATION

Code	Range	Accuracy	Resolution	Square driver (L)	Power supply	Length	Weight
IST-W30A	6~30N.m	clockwise: ±2% counter-clockwise: ±3%	0.01N.m	1/4"	2×AA batteries	390mm	830g
IST-W135A	27~135N.m		0.1N.m	3/8"		415mm	950g
IST-W200A	40~200N.m		0.1N.m	1/2"		530mm	1.4kg
IST-W340A	68~340N.m		0.1N.m	1/2"		650mm	1.6kg
IST-W500A	100~500N.m	clockwise: ±2.5% counter-clockwise: ±3.5%	0.1N.m	3/4"		950mm	2.1kg
IST-W850A	170~850N.m		0.1N.m	3/4"		1220mm	2.55kg
IST-W1200A	240~1200N.m		1N.m	1"		1800mm	13kg
IST-W1500A	300~1500N.m		1N.m	1"		1800mm	13kg
IST-W2000A	400~2000N.m		1N.m	1"		1800mm	14kg
						1800mm	14kg

OPTIONAL ACCESSORY

Calibration cable	IST-W-CABLE
-------------------	-------------

TORQUE WRENCHES

ATTENTION: CLOCKWISE OPERATION ONLY

- According to DIN ISO 6789, ASME B107.300
- All-metal construction, sturdy and durable



IST-9WM335

SPECIFICATION

Code	IST-9WM30	IST-9WM60	IST-9WM100	IST-9WM200	IST-9WM335	IST-9WM500	IST-9WM800	IST-9WM1000
Range (clockwise)	6~30N.m	10~60N.m	20~100N.m	40~200N.m	65~335N.m	100~500N.m	160~800N.m	200~1000N.m
Accuracy	±6% (<10N.m) ±4% (≥10N.m)	±4%	±4%	±4%	±4%	±4%	±4%	±4%
Graduation	0.2N.m	0.25N.m	0.5N.m	1N.m	1N.m	2.5N.m	4N.m	5N.m
Square driver (D)	3/8"	3/8"	1/2"	1/2"	1/2"	3/4"	3/4"	3/4"
Length	318mm	388mm	443mm	468mm	528mm	855mm	1055mm	1055mm
Weight	820g	960g	1040g	1160g	1300g	5000g	5900g	5900g

INTERCHANGEABLE HEAD TORQUE WRENCHES

ATTENTION: CLOCKWISE
OPERATION ONLY



IST-11WM200



- According to DIN ISO 6789, ASME B107.300
- All-metal construction, sturdy and durable

SPECIFICATION

Code	Range (clockwise)	Accuracy	Graduation	Socket size (A×B)	Length	Weight
IST-11WM12	2.5~12N.m	±6% (<10N.m) ±4% (≥10N.m)	0.05N.m	12×9mm	284mm	580g
IST-11WM30	6.0~30N.m	±6% (<10N.m) ±4% (≥10N.m)	0.1N.m	12×9mm	303mm	720g
IST-11WM60	10~60N.m	±4%	0.5N.m	12×9mm	372mm	860g
IST-11WM125	25~125N.m	±4%	0.5N.m	12×9mm	427mm	940g
IST-11WM200	40~200N.m	±4%	1N.m	18×14mm	460mm	1060g
IST-11WM335	65~335N.m	±4%	1N.m	18×14mm	520mm	1200g

RATCHET HEAD (optional)

Code	Square driver	Applicable wrenches
IST-11WM-R1	1/4"	IST-11WM12 IST-11WM30
IST-11WM-R2	3/8"	IST-11WM12 IST-11WM30 IST-11WM60 IST-11WM125
IST-11WM-R3	1/2"	IST-11WM200 IST-11WM335
IST-11WM-R4*	3/4"	IST-11WM200 IST-11WM335



OPEN END HEAD (optional)

Code	Open size	Applicable wrenches
IST-11WM-K8	8mm	IST-11WM12 IST-11WM30 IST-11WM60 IST-11WM125
IST-11WM-K10	10mm	
IST-11WM-K13	13mm	
IST-11WM-K14	14mm	
IST-11WM-K15	15mm	
IST-11WM-K17	17mm	
IST-11WM-K19*	19mm	
IST-11WM-K13A	13mm	IST-11WM200 IST-11WM335
IST-11WM-K14A	14mm	
IST-11WM-K15A	15mm	
IST-11WM-K17A	17mm	
IST-11WM-K19A	19mm	
IST-11WM-K22A	22mm	
IST-11WM-K24A	24mm	
IST-11WM-K27A*	27mm	
IST-11WM-K30A*	30mm	
IST-11WM-K32A*	32mm	

BOX END HEAD (optional)

Code	Open size	Applicable wrenches
IST-11WM-M8	8mm	IST-11WM12 IST-11WM30 IST-11WM60 IST-11WM125
IST-11WM-M10	10mm	
IST-11WM-M13	13mm	
IST-11WM-M14	14mm	
IST-11WM-M15	15mm	
IST-11WM-M17	17mm	
IST-11WM-M19	19mm	
IST-11WM-M13A	13mm	IST-11WM200 IST-11WM335
IST-11WM-M14A	14mm	
IST-11WM-M15A	15mm	
IST-11WM-M17A	17mm	
IST-11WM-M19A	19mm	
IST-11WM-M22A	22mm	
IST-11WM-M24A	24mm	
IST-11WM-M27A	27mm	
IST-11WM-M30A	30mm	
IST-11WM-M32A	32mm	

*Torque value needs to be corrected with those heads

MECHANICAL TORQUE WRENCHES (DIGITAL SETTING)



ATTENTION: CLOCKWISE OPERATION ONLY

ATTENTION: DISPLAY PRE-SET TORQUE VALUE (NOT REAL TIME TORQUE)

- Unit: N.m, in.lb, ft.lb, kg.cm
- Mechanical "click" torque wrench, the pre-set torque value is shown on the display

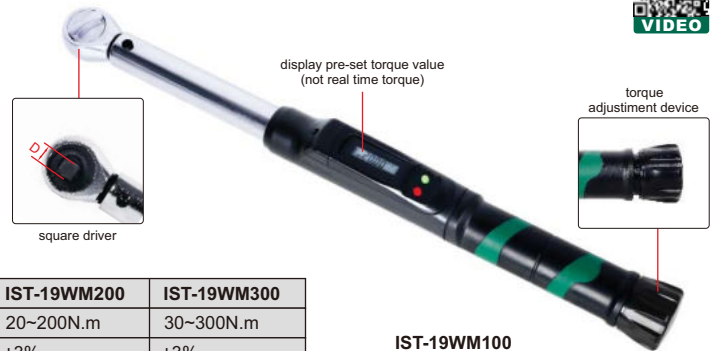

IST-19WM100

SPECIFICATION

Code	IST-19WM60	IST-19WM100	IST-19WM140	IST-19WM200	IST-19WM300
Range (clockwise)	6~60N.m	10~100N.m	14~140N.m	20~200N.m	30~300N.m
Accuracy	±3%	±3%	±3%	±3%	±3%
Graduation	0.1N.m	0.1N.m	0.1N.m	0.1N.m	0.1N.m
Square driver (D)	3/8"	3/8"	1/2"	1/2"	1/2"
Length	382mm	450mm	481mm	520mm	585mm
Weight	1.3kg	1.4kg	1.45kg	1.6kg	1.8kg

PRESET TORQUE WRENCHES

ATTENTION: CLOCKWISE OPERATION ONLY

- Torque is preset, to prevent adjustment by mistake during use
- The torque is set at the factory before delivery. Customers can also set the torque with torque adjustment tool (IST-PW-TOOL, optional) and digital torque testers (IST-TT□□□, optional)
- Clockwise operation only



IST-PW60

SPECIFICATION

Code	IST-PW12	IST-PW20	IST-PW30	IST-PW60	IST-PW125	IST-PW200
Adjustable range *	2.5~12N.m	4~20N.m	6~30N.m	10~60N.m	25~125N.m	40~200N.m
Accuracy	±3%	±3%	±3%	±3%	±3%	±3%
Square driver (D)	1/4"	1/4"	3/8"	3/8"	3/8"	1/2"
Length	184mm	184mm	214mm	255mm	366mm	457mm
Weight	450g	450g	500g	560g	790g	1200g

Code	IST-PW340	IST-PW500	IST-PW650	IST-PW800	IST-PW1000A	IST-PW1000B
Adjustable range *	65~340N.m	100~500N.m	150~650N.m	160~800N.m	200~1000N.m	200~1000N.m
Accuracy	±3%	±3%	±4%	±4%	±4%	±4%
Square driver (D)	1/2"	3/4"	3/4"	3/4"	3/4"	1"
Length	691mm	910mm	910mm	1037mm	1265mm	1265mm
Weight	1960g	2800g	2800g	5000g	6000g	6000g



torque adjustment tool (optional)

OPTIONAL ACCESSORY

Torque adjustment tool IST-PW-TOOL

*Adjust to a fixed torque value according to customer requirements before delivery

DIAL TORQUE WRENCHES



- Clockwise and counter-clockwise operation
- According to DIN ISO 6789, ASME B107.300

SPECIFICATION

Code	IST-DW18	IST-DW35	IST-DW70	IST-DW140
Range	3.6~18N.m 30~150in.lb	7~35N.m 60~300in.lb	14~70N.m 120~600in.lb	28~140N.m 20~100ft.lb
Accuracy	±3%	±3%	±3%	±3%
Graduation	0.2N.m 2in.lb	0.5N.m 5in.lb	1N.m 10in.lb	2N.m 1ft.lb
Square driver (D)	3/8"	3/8"	3/8"	1/2"
Length	254mm	254mm	378mm	546mm
Weight	480g	480g	820g	1300g



IST-DW70

ELECTRONIC BALANCES (0.1mg)

DATA
OUTPUT

- Electromagnetic sensor
- Unit: g, ct, oz, lb
- Weighing, counting, taring
- Data output



calibration weight
(included)

SPECIFICATION

Code	8304-120	8304-220
Maximum weighing	120g	220g
Minimum weighing	10mg	10mg
Resolution (d)	0.1mg	0.1mg
Verification interval (e)	1mg	1mg
Accuracy (m is load)	m≤50g: ±0.5mg; 50g<m≤120g: ±1mg	m≤50g: ±0.5mg; 50g<m≤200g: ±1mg; m>200g: ±1.5mg
Weighing pan size (Ød)	Ø90mm	
Operation temperature	10~30°C	
Operation humidity	20~85% RH	
Power supply	power adapter (12V/2A)	
Dimension (L×W×H)	230×310×320mm	



8304-120

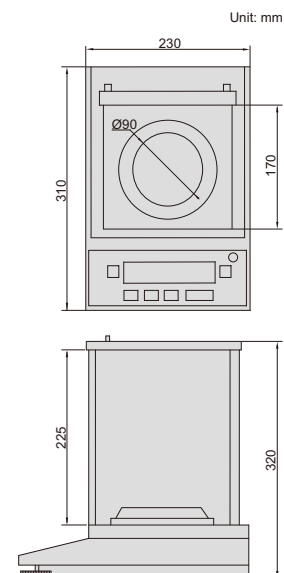

OPTIONAL ACCESSORY

RS232 cable	8304-CABLE
Printer	8304-PRINTER

ELECTRONIC BALANCES (1mg)

DATA
OUTPUT

- Aluminum alloy shell, wind shield, three side glass sliding doors
- Electromagnetic balance sensor
- Unit: g, ct, ozt, oz, gn, dwt, mg
- Weighing, counting, taring
- Data output
- With a hook at the bottom



calibration weight
(included)



8303-520

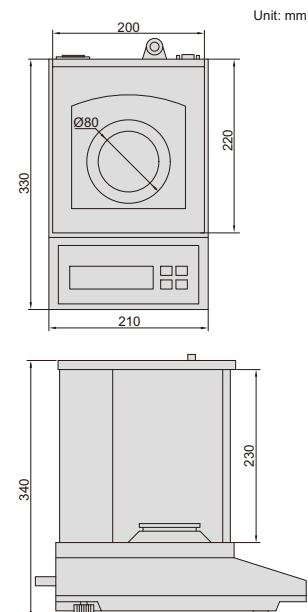

SPECIFICATION

Code	8303-220	8303-320	8303-520	8303-620	8303-1020
Maximum weighing	220g	320g	520g	620g	1020g
Minimum weighing	20mg	20mg	100mg	100mg	100mg
Resolution (d)	1mg	1mg	1mg	1mg	1mg
Verification interval (e)	10mg	10mg	10mg	10mg	10mg
Accuracy	load capacity≤500g: ±5mg; load capacity>500g: ±10mg				
Weighing pan size (Ød)	Ø80mm			Ø120mm	
Operation temperature	15~30°C		18~23°C		
Operation humidity	40%~80% RH		50%~70% RH		
Power supply	220V, 50/60Hz				
Dimension (L×W×H)	330×210×340mm				

OPTIONAL ACCESSORY

RS232 cable	8301-CABLE*
Printer	8303-PRINTER

*Used to connect with computers

ELECTRONIC BALANCES

- Automatic zero when power on
- Unit: g (gram), ct (carat), ozt (troy ounce)
- Weighing, counting, taring
- Overload alarm
- Data output



calibration weight
(included in 8301-300,
8301-600 and 8301-1200)



windshield
(included in 8301-300,
8301-600 and 8301-1200)



8301-3000

SPECIFICATION

Code	8301-300	8301-600	8301-1200	8301-3000	8301-6000
Maximum weighing	300g	600g	1200g	3000g	6000g
Minimum weighing	0.2g	0.2g	0.2g	2g	2g
Resolution (d)	0.01g	0.01g	0.01g	0.1g	0.1g
Verification interval (e)	0.1g	0.1g	0.1g	1g	1g
Accuracy (m is load)	m≤50g: ±0.05g; 50g<m≤200g: ±0.1g; m>200g: ±0.15g		m≤500g: ±0.5g; 500g<m≤2000g: ±1g; m>2000g: ±1.5g		
Weighing pan size	Ø135mm		190×160mm		
Operation temperature	0~40°C				
Operation humidity	≤80% RH				
Power supply	220V, 50/60Hz				
Dimension (L×W×H)	215×196×62mm				

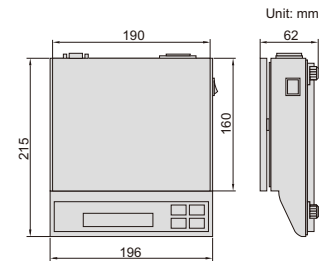

OPTIONAL ACCESSORY

RS232 cable 8301-CABLE

WEIGHING SCALES (ECONOMIC TYPE)

SPECIFICATION

Code	8003-3	8003-6	8003-10
Maximum weighing	3kg	6kg	10kg
Minimum weighing	0.4g	2.0g	20g
Resolution (d)	0.1g	0.5g	1g
Accuracy	±0.5g	±2.5g	±5g
Weighing pan size	157×157mm		
Working temperature	5~35°C		
Power supply	2×AAA batteries, power adapter		
Dimension (L×W)	160×225mm		



8003-3

- Unit: g, oz, ct, tl

WEIGHING SCALES (OIML CERTIFICATE)

- LCD display, with backlight
- Zero-setting, subtracting tare value
- Overload alarm
- Automatic power off
- OIML certificate (No. 0200-NAWI-04601)



SPECIFICATION

Code	8002-6M	8002-15M	8002-30M
Maximum capacity	3/6kg	6/15kg	15/30kg
Minimum capacity	20g	40g	100g
Resolution (d)	1/2g	2/5g	5/10g
Verification interval (e)	2g	5g	10g
Accuracy (m is load)	m≤3kg: ±1g 3kg<m≤6kg: ±2g	m≤6kg: ±2g 6kg<m≤15kg: ±5g	m≤15kg: ±5g 15kg<m≤30kg: ±10g
Operation temperature	-10~40°C		
Power	rechargeable battery (6V/3.2Ah), power adapter (12V/500mA)		
Dimensions of pan	263×204mm		



8002-30M

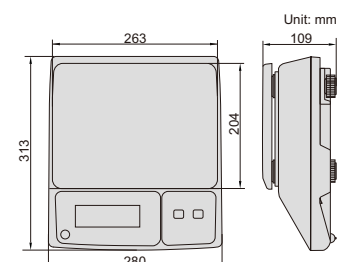

COUNTING SCALES

- LCD display, with backlight
- Zero-setting, subtracting tare value, counting, accumulation, checking alarm
- Overload alarm
- Units: kg, g, lb, tj, hj, lb-oz

SPECIFICATION

Code	8101-6	8101-15	8101-30
Maximum weighing	6kg	15kg	30kg
Minimum weighing	4g	10g	20g
Resolution (d)	0.2g	0.5g	1g
Accuracy (m is load)	m≤1kg: ±1g 1kg<m≤4kg: ±2g m>4kg: ±3g	m≤2.5kg: ±2.5g 2.5kg<m≤10kg: ±5g m>10kg: ±7.5g	m≤5kg: ±5g 5kg<m≤20kg: ±10g m>20kg: ±15g
Operation temperature	-10~40°C		
Power	rechargeable battery (6V/3.2Ah), power adapter (12V/500mA)		
Dimensions of pan	263×204mm		



8101-30

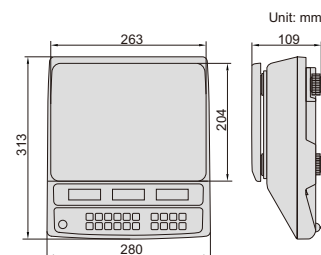

WEIGHING SCALES (HIGH PRECISION)

- LCD display, with backlight
- Zero-setting, subtracting tare value
- Overload alarm
- Automatic power off

SPECIFICATION

Code	8001-6	8001-15	8001-30
Maximum weighing	6kg	15kg	30kg
Minimum weighing	4g	10g	20g
Resolution (d)	0.2g	0.5g	1g
Accuracy (m is load)	m≤1kg: ±1g 1kg<m≤4kg: ±2g m>4kg: ±3g	m≤2.5kg: ±2.5g 2.5kg<m≤10kg: ±5g m>10kg: ±7.5g	m≤5kg: ±5g 5kg<m≤20kg: ±10g m>20kg: ±15g
Units	kg, lb		
Operation temperature	-10~40°C		
Power	rechargeable battery (6V/3.2Ah), power adapter (12V/500mA)		
Dimensions of pan	263×204mm		



8001-30

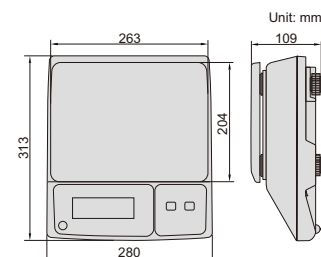

ELECTRONIC POCKET SCALE (ECONOMIC TYPE)

- LCD display, with backlight
- Zero-setting, subtracting tare value, counting
- Overload alarm
- Automatic power off

SPECIFICATION

Code	8601-100
Maximum weighing	100g
Minimum weighing	0.1g
Resolution (d)	0.01g
Accuracy (m is load)	0.1g≤m≤1g: ±0.03g; 1g<m≤30g: ±0.05g 30g<m≤50g: ±0.07g; m>50g: ±0.14g
Units	g, oz, dwt, ozt
Dimension of pan	55×64mm
Dimension (L×W×H)	108×65×21mm
Operation temperature	-10~40°C
Power supply	2×AAA batteries



8601-100



use of pan

**ATTENTION:
LOW ACCURACY**

ELECTRONIC POCKET SCALE (ECONOMIC TYPE)

ATTENTION:
LOW ACCURACY

- LCD display, with backlight
- Zero-setting, subtracting tare value, counting
- Overload alarm
- Automatic power off

SPECIFICATION

Code	8602-200
Maximum weighing	200g
Minimum weighing	0.2g
Resolution (d)	0.02g
Accuracy (m is load)	0.2g ≤ m ≤ 2g: ±0.06g; 2g < m ≤ 60g: ±0.1g 60g < m ≤ 100g: ±0.14g; m > 100g: ±0.28g
Units	g, oz, dwt, ozt
Dimension of pan	55×64mm
Dimension (L×W×H)	120×70×17mm
Operation temperature	-10~40°C
Power supply	2×CR2032 batteries



8602-200



use of pan

ELECTRONIC CRANE SCALES

IP65
WATERPROOF



8201-150KG



Remote controller
(included)

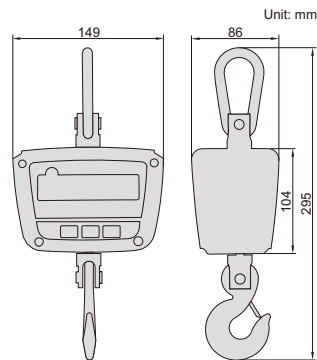

Unit: mm

- Dust/waterproof level: IP65
- LED display, remote control
- Low voltage indicator
- Unit: kg, lb
- Automatic power off
- Overload alarm
- 360° safe rotary hook and shackle
- Aluminum alloy die casting case with high strength

SPECIFICATION

Code	8201-50KG	8201-150KG	8201-300KG
Maximum weighing	50kg	150kg	300kg
Minimum weighing	0.4kg	1.0kg	2.0kg
Resolution (d)	0.02kg/0.01kg	0.05kg/0.02kg	0.10kg/0.05kg
Verification interval (e)	0.02kg	0.05kg	0.10kg
Accuracy	±0.02kg	±0.05kg	±0.10kg
Operation temperature	-10~40°C		
Operation humidity	30%~90% RH		
Overload alarm	100%F.S.+9e		
Maximum safe load	125%F.S.		
Limited overload	400%F.S.		
Power supply	rechargeable battery 6V/3Ah (for 40 hours working)		
Stable reading time	≤8s		

STANDARD DELIVERY

Main unit	1 pc
Remote controller	1 pc
Battery charger	1 pc

ELECTRONIC CRANE SCALES (BASIC TYPE)



8202-150KG



Remote controller
(included)

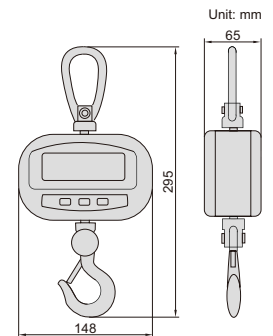

Unit: mm

- LED display, remote control
- Low voltage indicator
- Unit: kg, lb
- Automatic power off
- Overload alarm
- 360° safe rotary hook and shackle
- Plastic case

SPECIFICATION

Code	8202-50KG	8202-150KG	8202-300KG
Maximum weighing	50kg	150kg	300kg
Minimum weighing	0.4kg	1.0kg	2.0kg
Resolution (d)	0.02kg/0.01kg	0.05kg/0.02kg	0.10kg/0.05kg
Verification interval (e)	0.02kg	0.05kg	0.10kg
Accuracy	±0.02kg	±0.05kg	±0.10kg
Operation temperature	-10~40°C		
Operation humidity	30%~90% RH		
Overload alarm	100%F.S.+9e		
Maximum safe load	125%F.S.		
Limited overload	400%F.S.		
Power supply	4×1.5V AA batteries (for 40 hours working)		
Stable reading time	≤8s		

STANDARD DELIVERY

Main unit	1 pc
Remote controller	1 pc

PLATFORM SCALES

DATA
OUTPUT



printer (optional)

- LCD large screen display with LED backlight
- Weighing, overweight alarm, counting, keyboard lock, accumulating, auto zero and animal scale
- Units: kg, g, lb, oz



8501-AL150

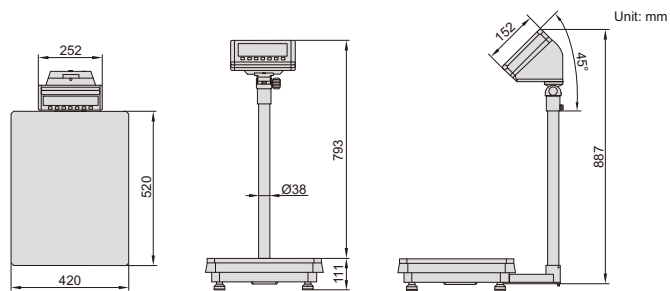

Unit: mm

SPECIFICATION

Code	8501-AL60	8501-AL150	8501-AL300
Maximum weighing	60kg	150kg	300kg
Minimum weighing	100g	200g	400g
Resolution (d)	5g	10g	20g
Accuracy	±10g	±20g	±30g
Operation temperature	-10~40°C		
Material	platform: stainless steel, base: die-cast aluminum		
Dimension of platform	420×520mm		
Power	rechargeable lead acid battery (6V/4Ah)		
Output	RS232		
Weight	18.3kg		

OPTIONAL ACCESSORY

Printer	8001-PRINTER
---------	--------------

WEIGHT SETS



- Supplied with manufacturer inspection certificate



8910-200GM1

SPECIFICATION AND SHAPE

Weight	Specification				
	1mg~100g	1mg~200g	1mg~1kg	1mg~2kg	1mg~5kg
1mg	◆	◆	◆	◆	◆
2mg	◆◆*	◆◆*	◆◆*	◆◆*	◆◆◆*
5mg	◆	◆	◆	◆	◆
10mg	◆	◆	◆	◆	◆
20mg	◆◆*	◆◆*	◆◆*	◆◆*	◆◆◆*
50mg	◆	◆	◆	◆	◆
100mg	◆	◆	◆	◆	◆
200mg	◆◆*	◆◆*	◆◆*	◆◆*	◆◆◆*
500mg	◆	◆	◆	◆	◆
1g	◆◆	◆◆	◆◆	◆◆	◆◆
2g	◆◆*	◆◆*	◆◆*	◆◆*	◆◆◆*
5g	◆	◆	◆	◆	◆
10g	◆	◆	◆	◆	◆
20g	◆◆*	◆◆*	◆◆*	◆◆*	◆◆◆*
50g	◆	◆	◆	◆	◆
100g	◆	◆	◆	◆	◆
200g		◆◆*	◆◆*	◆◆*	◆◆◆*
500g			◆	◆	◆
1kg			◆	◆	◆
2kg				◆◆*	◆◆◆*
5kg					◆
Quantity	21 pcs	23 pcs	25 pcs	27 pcs	28 pcs
Total range	1mg~211.11g	1mg~611.11g	1mg~2111.11g	1mg~6111.11g	1mg~11111.11g

- ◆ sheet
- ◆* sheet, with mark
- ◆ cylinder
- ◆* cylinder, with mark

Code	Specification	Class and material
8910-100GM1	1mg~100g	M1 (304 stainless steel)
8910-200GM1	1mg~200g	M1 (304 stainless steel)
8910-1KGM1	1mg~1kg	M1 (304 stainless steel)
8910-2KGM1	1mg~2kg	M1 (304 stainless steel)
8910-5KGM1	1mg~5kg	M1 (304 stainless steel)

INCH PRODUCTS

DIAL CALIPERS

SHOCK PROOF

INSPECTION CERTIFICATE

- Dial indicator graduation 0.001"
- Shockproof dial indicator
- Made of stainless steel



1311-6

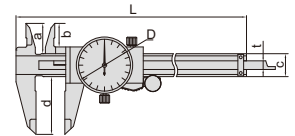

Code	Range	Accuracy	L	a	b	c	d	D	t
1311-6*	0-6"	±0.0015"	9.252"	0.827"	0.650"	0.630"	1.575"	1.535" DIA	0.256"
1311-8*	0-8"	±0.0020"	11.339"	0.945"	0.748"	0.630"	1.890"	1.535" DIA	0.256"
1311-12*	0-12"	±0.0020"	16.142"	1.102"	0.866"	0.787"	2.441"	1.752" DIA	0.295"

*Supplied with manufacturer inspection certificate

OUTSIDE MICROMETERS

INSPECTION CERTIFICATE



3203-2A

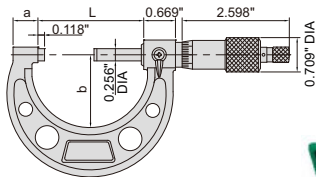

3203-44A

- Graduation 0.0001"
- Carbide measuring faces
- Ratchet stop type
- Supplied with setting standards (except 0-1")

Individual

Code	Range	Accuracy	L	a	b
3203-1A*	0-1"	0.00015"	1.260"	0.354"	1.102"
3203-2A*	1-2"	0.00015"	2.244"	0.551"	1.496"
3203-3A*	2-3"	0.00020"	3.228"	0.591"	1.929"
3203-4A*	3-4"	0.00020"	4.213"	0.591"	2.362"
3203-5A*	4-5"	0.00025"	5.236"	0.650"	2.874"
3203-6A*	5-6"	0.00025"	6.220"	0.650"	3.346"

Set

Code	Range	Micrometers included	Packaging
3203-33A*	0-3"	3203-1A, 3203-2A, 3203-3A	blow mould case
3203-44A*	0-4"	3203-1A, 3203-2A, 3203-3A, 3203-4A	blow mould case
3203-66A*	0-6"	3203-1A, 3203-2A, 3203-3A, 3203-4A, 3203-5A, 3203-6A	blow mould case

*Supplied with manufacturer inspection certificate

DEPTH MICROMETER

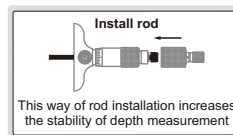

3241-6

- Graduation 0.001"
- Micrometer head accuracy: ±0.00012"
- Rod accuracy: ±[0.001+0.0005(L/3)]", L is the measuring range in inch
- Rods with flat end
- Ratchet stop

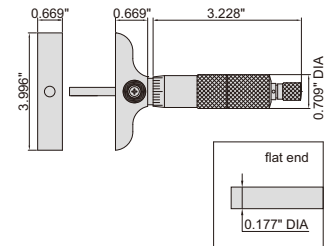

Code	Range	Rods
3241-6	0-6"	6 pcs

DIAL INDICATOR

INSPECTION CERTIFICATE



2307-1

- Meet ASME B89.1.10M-2001
- Graduation: 0.001"
- With lug back
- Supplied with limit pointers and bezel clamp
- Optional accessory: backs, contact points

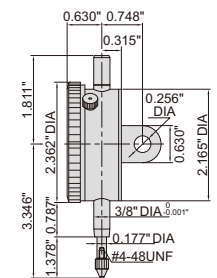

Code	Range	Accuracy		Range/rev	Dial reading
		First 2.5 rev	Overall		
2307-1*	1"	±0.001"	±0.002"	0.1"	0-100

*Supplied with manufacturer inspection certificate

INCH PRODUCTS

DIAL TEST INDICATOR

INSPECTION CERTIFICATE

JEWELLED BEARING



2380-31

- Jeweled bearing
- Carbide contact point
- Two measuring directions
- Anti magnetic body
- Supplied with two clamps: 5/32" DIA and 3/8" DIA
- Optional accessory: styli

Code	Range	Graduation	Accuracy	Dial reading	A (DIA)	L
2380-31*	0.03"	0.001"	±0.001"	0-15-0	1.181"	0.50"

*Supplied with manufacturer inspection certificate

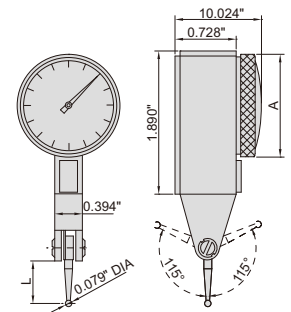
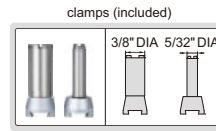

FEELER GAGE

- 0.010" is made of brass, others are made of hardened alloy steel
- Each blade is marked with inch/metric size



4608-31

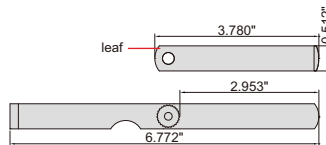

Thickness of leaves included	Accuracy
0.010" (brass)	±0.00039"
0.0015", 0.002"	±0.0002"
0.0025", 0.003", 0.004", 0.005", 0.006", 0.007"	±0.00028"
0.008", 0.009"	±0.00035"
0.010", 0.011"	±0.00039"
0.012", 0.013"	±0.00047"
0.014", 0.015"	±0.00051"
0.016", 0.017"	±0.00055"
0.018", 0.019"	±0.00059"
0.020", 0.021"	±0.00067"
0.022", 0.023"	±0.00071"
0.024", 0.025", 0.026"	±0.00075"
0.028"	±0.00091"
0.030"	±0.00094"
0.032", 0.035"	±0.00102"

Code	Range	Quantity of Leaves
4608-31	0.0015"~0.035"	32

BORE GAGES

- Optional accessory: setting ring (code 6313), long handle (code 7351) bore gage setter (code 2395-400)

ATTENTION: NOT SUITABLE FOR 0.00005" OR 0.0001" DIAL INDICATORS



2323-6

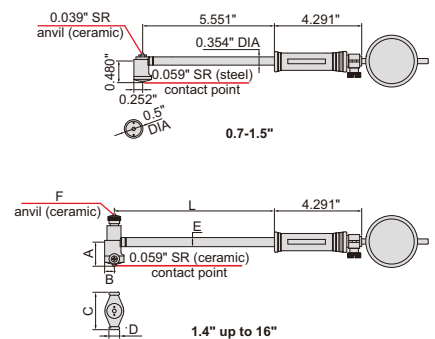

With dial indicator

Code	Range	Indicator	Accuracy	Repeatability
2323-15	0.7-1.5"	dial indicator, range 0.25", graduation 0.0005"	±0.00075"	0.00015"
2323-24	1.4-2.4"		±0.0009"	0.00015"
2323-6	2-6"		±0.0009"	0.00015"
2323-10	6-10"		±0.0009"	0.00015"
2323-16	10-16"		±0.0009"	0.00015"

Range	A	B	C	D	E	F	L
1.4-2.4"	0.866"	0.354"	10.063"	0.512" DIA	0.504" DIA	0.079" R	5.551"
2-6"	10.024"	0.354"	1.378"	0.512" DIA	0.504" DIA	0.079" R	5.551"
6-10"	2.224"	0.512"	2.933"	0.591" DIA	0.504" DIA	0.079" R	9.488"
10-16"	3.406"	0.591"	3.996"	0.591" DIA	0.571" DIA	0.098" R	9.488"

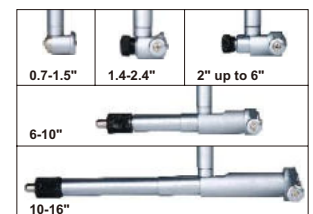

CODE NO. INDEX

CODE	PAGE	CODE	PAGE	CODE	PAGE	CODE	PAGE
00		1147.....	26	1223.....	9	2132.....	79
0010.....	173	1148.....	27	1224.....	8	2133.....	56
0020.....	178	1149.....	25	1236.....	11	2138.....	58
01		1150.....	32	1239.....	9	2139.....	58
0110.....	171	1151.....	32	1240.....	28	2140.....	56
0120.....	172	1154.....	34	1244.....	28	2141.....	29
0130.....	171	1155.....	30	1250.....	33	2144.....	99
0131.....	172	1156.....	31	1251.....	33	2151.....	78
02		1157.....	31	1253.....	33	2152.....	52
0210.....	168	1160.....	103	1262.....	17	2153.....	53
03		1161.....	22	1267.....	102	2164.....	80
0310.....	170	1162.....	25	1273.....	24	2166.....	80
0311.....	170	1165.....	23	1275.....	111	2168.....	81
04		1166.....	112	1281.....	24	2170.....	184
0411.....	182	1167.....	25	13		2171.....	94
0431.....	182	1168.....	25	1312.....	7	2172.....	96
11		1169.....	19	1340.....	27	2174.....	94
1102.....	4	1170.....	7	1351.....	33	2175.....	183
1103.....	4	1171.....	7	15		2176.....	94
1106.....	10	1172.....	23	1501.....	55	2179.....	184
1108.....	5	1176.....	17	1520.....	16	2182.....	82
1109.....	5	1177.....	20	1524.....	21	2183.....	55
1110.....	6	1178.....	18	1525.....	21	2184.....	80
1111.....	7	1179.....	22	1526.....	13~14	2186.....	81
1113.....	3	1180.....	102	1527.....	22	2187.....	81
1114.....	5	1181.....	24	1528.....	23	2188.....	55
1118.....	4	1183.....	19	1530.....	15	22	
1119.....	5	1185.....	19	1532.....	20	2222.....	78
1120.....	16	1186.....	21	1533.....	23	2223.....	78
1121.....	16	1187.....	19	1536.....	24	2275.....	98
1122.....	21	1188.....	19	1537.....	102	2276.....	111
1123.....	20	1189.....	21	1538.....	25	2278.....	112
1124.....	15	1191.....	18	1539.....	24	23	
1125.....	13	1192.....	20	1540.....	27	2301.....	63
1128.....	18	1193.....	6	21		2302.....	64
1129.....	18	1196.....	5	2103.....	57	2308.....	63
1130.....	6	1199.....	17	2104.....	57	2309.....	65
1135.....	11	12		2108.....	59	2310.....	64
1136.....	11	1201.....	8	2112.....	57	2311.....	63
1138.....	20	1202.....	8	2114.....	59	2313.....	63
1139.....	7	1203.....	8	2115.....	59	2314.....	63
1140.....	28	1204.....	8	2117.....	60	2316.....	64
1141.....	26	1205.....	9	2118.....	60	2322.....	51
1142.....	26	1207.....	11	2121.....	78	2324.....	64
1143.....	26	1208.....	12	2122.....	51	2328.....	64
1144.....	26	1214.....	11	2124.....	47	2333.....	78
1145.....	28	1215.....	12	2126.....	52	2341.....	29
1146.....	34	1217.....	8	2131.....	79	2342.....	29

**CODE NO. INDEX**

CODE	PAGE
2343.....	29
2344.....	165
2361.....	80
2364.....	79
2372.....	96
2373.....	96
2374.....	95
2380.....	66
2381.....	66
2383.....	67
2385.....	120
2386.....	67
2394.....	122
2396.....	69
2397.....	122
2398.....	67
2399.....	66
24	
2480.....	67
27	
2771.....	96
28	
2824.....	53
2825.....	52
2828.....	53
2841.....	82
2852.....	52
2853.....	53
2862.....	80
2871.....	79
2872.....	80
2876.....	80
2878.....	75
2879.....	79
29	
2931.....	12
31	
3101.....	35
3108.....	35
3109.....	35
3127.....	48
3128.....	50
32	
3202.....	36
3203.....	36
3206.....	37
3210.....	36
3220.....	50

CODE	PAGE
3221.....	51
3222.....	51
3227.....	49
3228.....	49
3230.....	41
3232.....	41
3233.....	42
3234.....	43
3236.....	37
3238.....	45
3239.....	43
3241.....	30
3260.....	42
3261.....	42
3262.....	43
3266.....	41
3280.....	44
3281.....	39
3282.....	44
3283.....	45
3285.....	45
3287.....	38
3290.....	44
3291.....	40
3293.....	46
33	
3331.....	38
3332.....	38
3334.....	81
3350.....	34
35	
3506.....	37
3520.....	50
3521.....	50
3530.....	41
3532.....	41
3533.....	42
3534.....	43
3539.....	43
3540.....	30
3560.....	42
3561.....	42
3562.....	43
3565.....	35
3566.....	41
3580.....	44
3581.....	39
3583.....	45

CODE	PAGE
3590.....	44
3591.....	40
3594.....	45
40	
4006.....	118
41	
4100.....	82
4101.....	83
4108.....	84
4120.....	90
4121.....	92
4124.....	88
4129.....	91
4130.....	88
4131.....	92
4139.....	89
4141.....	97
4142.....	97
4143.....	118
4147.....	98
4155.....	119
4160.....	84
4166.....	85
4176.....	83
4180.....	99
4190.....	93
42	
4206.....	54
4208.....	54
4209.....	54
46	
4601.....	99
4602.....	100
4605.....	99
4621.....	100
4630.....	103
47	
4700.....	98
4707.....	98
4721.....	77
4725.....	76
4728.....	77
4747.....	98
4770.....	97
4771.....	77
4778.....	95
4779.....	95
4780.....	94

CODE	PAGE
4781.....	94
4782.....	77
4786.....	76
4789.....	76
4790.....	97
4791.....	97
4792.....	98
4793.....	98
4797.....	95
4799.....	95
48	
4801.....	101
4802.....	102
4803.....	108
4804.....	102
4808.....	108
4809.....	108
4810.....	101
4812.....	101
4820.....	101
4824.....	100
4830.....	104
4831.....	104
4832.....	104
4833.....	103
4834.....	104
4835.....	105
4836.....	104
4837.....	103
4838.....	105
4839.....	107
4840.....	106
4841.....	107
4842.....	109
4843.....	109
4844.....	102
4845.....	166
4846.....	106
4847.....	106
4848.....	104
4849.....	106
4850.....	106
4851.....	106
4852.....	103
4853.....	108
4854.....	109
4855.....	103
4860.....	100

CODE NO. INDEX

CODE	PAGE
49	
4902.....	184
4903.....	185
4910.....	185
4911.....	185
4912.....	186
4913.....	186
4914.....	186
4917.....	187
4918.....	187
4920.....	186
50	
5013.....	114
5022.....	113
5023.....	113
5024.....	113
5041.....	113
5042.....	113
5052.....	114
5063.....	114
5064.....	107
5071.....	107
5072.....	107
5091.....	114
51	
5101.....	150
5102.....	151
5103.....	150
5106.....	153
5107.....	151
52	
5201.....	183
53	
5301.....	144
5302.....	143
5307.....	146
5309.....	146
5311.....	147
5313.....	144
57	
5700.....	176
5701.....	175
5702.....	177
61	
6140.....	9
6141.....	28
6143.....	19
6144.....	10

CODE	PAGE
6145.....	10
6146.....	10
62	
6200.....	70
6201.....	70
6202.....	70
6207.....	71
6208.....	69
6210.....	69
6211.....	71
6214.....	72
6216.....	71
6217.....	72
6221.....	71
6224.....	71
6225.....	72
6226.....	72
6227.....	73
6228.....	71
6229.....	70
6230.....	73
6272.....	71
6282.....	65-66
6284.....	68
6291.....	68
6293.....	68
6294.....	68
6295.....	68
6296.....	68
6297.....	68
6298.....	67
63	
6300.....	46
6301.....	46
6310.....	46
6312.....	87
6381.....	46
65	
6511.....	118
6520.....	119
6521.....	119
6526.....	120
6527.....	119
6531.....	117
6533.....	117
6534.....	118
6535.....	119
6547.....	119

CODE	PAGE
6553.....	122
6556.....	122
6557.....	122
6562.....	121
6566.....	121
6567.....	121
6568.....	121
6572.....	121
6573.....	121
6582.....	120
6584.....	120
68	
6801.....	117
6805.....	115
6832.....	105
6841.....	73
6862.....	74
6863.....	74
6864.....	74
6865.....	75
6866.....	73
6867.....	73
6869.....	74
6876.....	73
6884.....	84
6887.....	116
6888.....	116
6889.....	116
6890.....	117
6896.....	115
6897.....	116
69	
6900.....	114
6902.....	115
6990.....	113
71	
7101.....	123
7106.....	61
7107.....	61-62
7110.....	111
7111.....	99
7114.....	55
7119.....	110
7120.....	111
7123.....	111
7130.....	62
7140.....	110
7142.....	110

CODE	PAGE
7143.....	110
7144.....	110
7145.....	110
7160.....	159
7161.....	159
7162.....	159
7163.....	159
7164.....	160
72	
7202.....	112
7203.....	112
7205.....	112
7230.....	113
7231.....	113
7232.....	113
7247.....	109
7260.....	109
7261.....	109
7262.....	109
73	
7302.....	1
7304.....	3
7315.....	2-3
7330.....	66
7331.....	66
7332.....	66
7341.....	86
7342.....	86
7351.....	54
7353.....	54
7381.....	40
7382.....	38
7391.....	40
7394.....	39
75	
7511.....	157
7512.....	158
7513.....	158
7514.....	158
7515.....	157
7516.....	157
7517.....	157
7518.....	158
7520.....	157
7522.....	158
7523.....	159
7524.....	158
7525.....	156

CODE NO. INDEX

CODE	PAGE
7526.....	156
76	
7600.....	179
80	
8001.....	211
8002.....	210
8003.....	210
81	
8101.....	211
82	
8201.....	212
8202.....	212
83	
8301.....	210
8303.....	209
8304.....	209
85	
8501.....	213
86	
8601.....	211
8602.....	212
89	
8910.....	213
91	
9130.....	168
9132.....	169
92	
9223.....	174
9224.....	173
9225.....	174
9241.....	180
9242.....	181
9246.....	181
9247.....	180
93	
9353.....	173
9362.....	169
94	
9407.....	134
95	
9501.....	165
9561.....	168
97	
9720.....	178
9721.....	179
9722.....	179
9723.....	179
DSW	

CODE	PAGE
DSW-A010.....	179
HDT	
HDT-BRV130.....	194
HDT-L410.....	198
HDT-L411.....	199
HDT-LP200.....	197
HDT-LP200B.....	197
HDT-MV290.....	192
HDT-MV290S.....	192
HDT-RA151.....	190
HDT-RW160.....	191
HDT-VD50A.....	191
HDT-VS530.....	196
ISD	
ISD-V150A.....	138~139
ISD-V250A.....	138~139
ISD-V300A.....	138~139
ISD-V220CNCA.....	139~140
ISD-VMM215.....	142~143
ISE	
ISE-2DT.....	183
ISF	
ISF-1DF□□□.....	201
ISF-DF□□□.....	202
ISF-F□□□.....	202
ISF-H20D.....	203
ISF-MT1K.....	202
ISF-MT500.....	203
ISF-P30D.....	203
ISF-RH62.....	204
ISF-RV61.....	203
ISF-S□□□.....	204
ISF-TG□□□.....	205
ISGF	
ISGF-0901.....	113
ISH	
ISH-BRV.....	195
ISH-DSA.....	200
ISH-DSD.....	200
ISH-DS-STANDA.....	200
ISH-MRD200.....	189
ISH-PHB.....	196
ISH-R150.....	190
ISH-RSR400.....	188
ISH-SAM.....	201
ISH-SDM.....	201
ISH-STAC.....	201
ISHB	

CODE	PAGE
ISHB-B300.....	200
ISHB-D300.....	193
ISHW	
ISHW-L20.....	199
ISL	
ISL-A1-□□□.....	124
ISL-A5-□□□.....	124
ISL-B5-□□□.....	124
ISL-DR2.....	123
ISL-DR3.....	123
ISM	
ISM-CM63.....	155
ISM-DL301.....	145
ISM-PM100.....	156
ISM-PM200SA.....	148
ISM-WF200.....	149
ISM-ZS100.....	152
ISM-ZS100T.....	152
ISM-ZS200.....	152
ISM-ZS30.....	154
ISM-ZS50.....	153
ISM-ZS50T.....	153
ISM-ZS70-S.....	154
ISO	
ISO-1000FN.....	164
ISO-1200FN.....	164
ISO-8000FN.....	163
ISP	
ISP-Z3015.....	135~136
ISQ	
ISQ-DG6.....	176
ISQ-DG8.....	177
ISQ-DRM31.....	178
ISQ-RM30.....	178
ISR	
ISR-C002.....	127
ISR-C003.....	129
ISR-C300.....	128~129
ISR-CS130-W.....	129
IST	
IST-04TT□□□.....	205
IST-11WM□□□.....	207
IST-19WM□□□.....	208
IST-9WM□□□.....	206
IST-DW□□□.....	208
IST-MG□□□.....	205
IST-PW□□□.....	208
IST-SD200.....	206

CODE	PAGE
IST-SD50.....	206
IST-W□□□.....	206
ISU	
ISU-100D.....	167
ISU-250C.....	167
ISU-720D.....	166
ISV	
ISV-E30.....	162
ISV-E40.....	162
ISV-K3915.....	160
ISV-K6015.....	160
ISV-P6.....	161
ISV-S106.....	161
ISY	
ISY-100.....	130~131
ISY-400.....	132
ISY-500.....	132
ISY-600.....	130
ISY-700.....	141
LDM	
LDM-030.....	133
LDM-065.....	133
QMS	
QMS-A110.....	137
RCT	
RCT-RA260.....	125
SPM	
SPM-1000.....	126
TLP	
TLP-300H.....	135
INCH PRODUCTS	
13	
1311.....	214
23	
2307.....	214
2323.....	215
2380.....	215
32	
3203.....	214
3241.....	214
46	
4608.....	215



INSIZE EUROPE S.L.
 Add: Plg. Ugaldeguren I P3-Hall 2
 48170-Zamudio (Bizkaia) Spain
 Tel: +34-94-4544308
 E-mail: europe@insize.com
 Website: www.insize-eu.com



www.insize-eu.com



The products with this mark are supplied with manufacturer inspection certificate



INSIZE Inspection Certificate

Product name	Digital Caliper	Traceable to	USA NIST No.821279484-10
Code No.	1108-150		Germany DKD No.D-K-15190-01-00
Measuring range	0-150mm / 0-6"	Inspector	<i>Doze</i>
Resolution	0.01mm / 0.0005"	Judgement	Passed
Serial No.	0910120004		
Standard temperature	20°C / 68°F		

Measuring Length	Permissible Error	Error		Measuring Length	Permissible Error	Error	
		External	Internal			External	Internal
0.4 DIA	+0.0005 -0.0010	/	0.0005	Φ10	+0.01 -0.02	/	0.01
2	±0.0010	-0.0005	/	50	±0.02	-0.01	/
4		-0.0005	/	100		-0.01	/
6		-0.0010	/	150		-0.02	/
8	±0.0015	/	/	200	±0.03	/	/
10		/	/	250		/	/
12		/	/	300		/	/



VIDEO

Please scan QR code to watch the demo videos of products.

Obtain information about our complete line of product from our website or general catalogue



Distributed by:

We reserve the right to change or modify the design and specification of products in this catalogue without prior notice.